



US00D486094S

(12) **United States Design Patent**  
**Candotti**

(10) **Patent No.:** **US D486,094 S**

(45) **Date of Patent:** **\*\* Feb. 3, 2004**

(54) **BUTTON**

(75) **Inventor:** **Riccardo Candotti**, Padua (IT)

(73) **Assignee:** **Cobra Trade S.A.**, Luxembourg (LU)

(\*\*) **Term:** **14 Years**

(21) **Appl. No.:** **29/156,941**

(22) **Filed:** **Mar. 11, 2002**

(30) **Foreign Application Priority Data**

Sep. 11, 2001 (IT) ..... PD200100048

(51) **LOC (7) Cl.** ..... **02-07**

(52) **U.S. Cl.** ..... **D11/226**

(58) **Field of Search** ..... D11/220, 200-214,  
D11/231-235; 24/623, 697.2, 689, 688,  
690, 662, 381, 385, 713.8; D8/383

(56) **References Cited**

**U.S. PATENT DOCUMENTS**

2,546,716 A \* 3/1951 Bedford, Jr. .... D11/220 X  
D288,185 S \* 2/1987 Derosa ..... D11/226  
D301,567 S \* 6/1989 Burke ..... D11/220

D319,201 S \* 8/1991 Aoki ..... D11/220  
D337,967 S \* 8/1993 Wright ..... D11/226  
D350,501 S \* 9/1994 Schriever ..... D11/220  
2003/0057237 A1 3/2003 Stull et al. .... 222/490

\* cited by examiner

*Primary Examiner*—Catherine R. Oliver

(74) *Attorney, Agent, or Firm*—Welsh & Katz, Ltd.

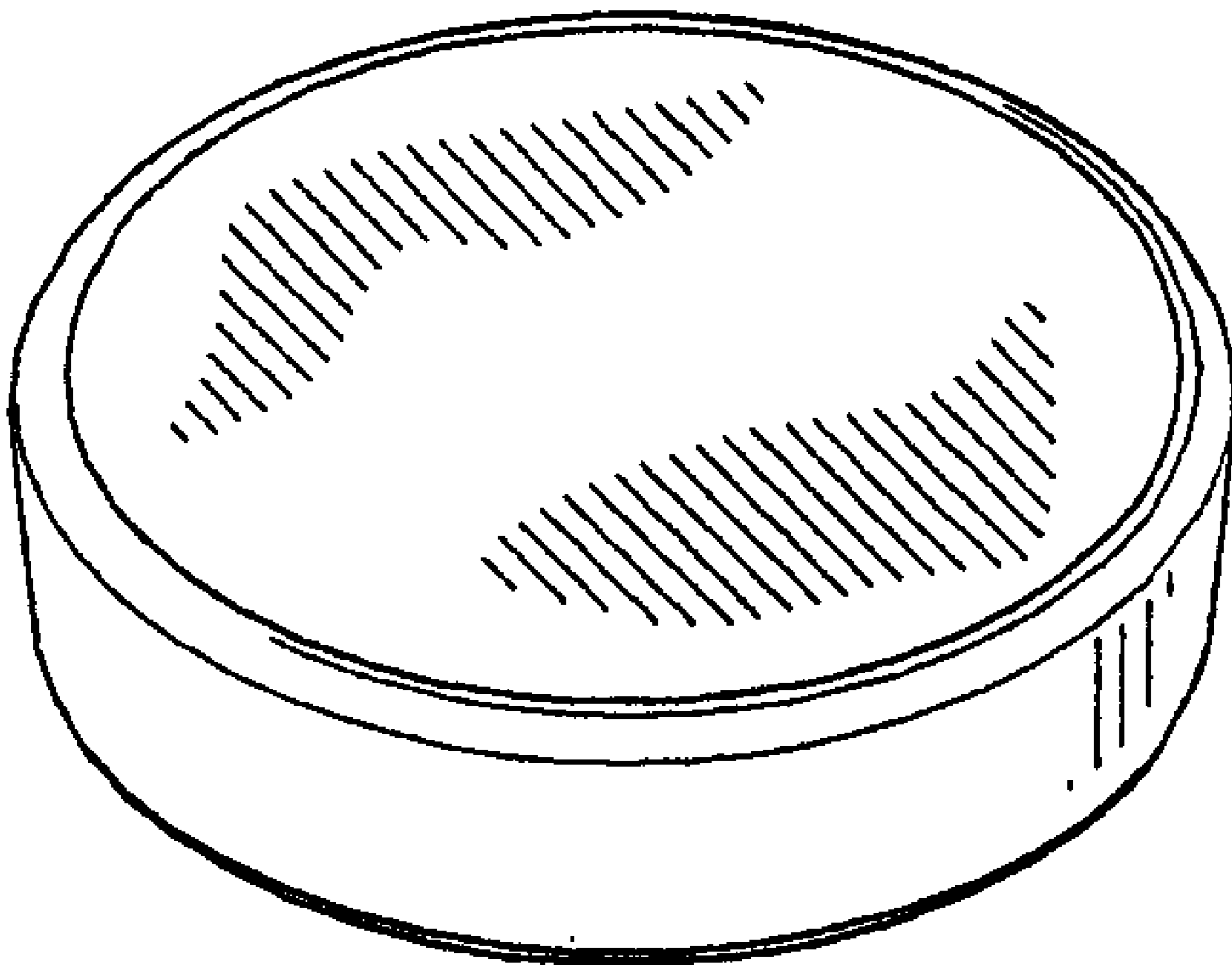
(57) **CLAIM**

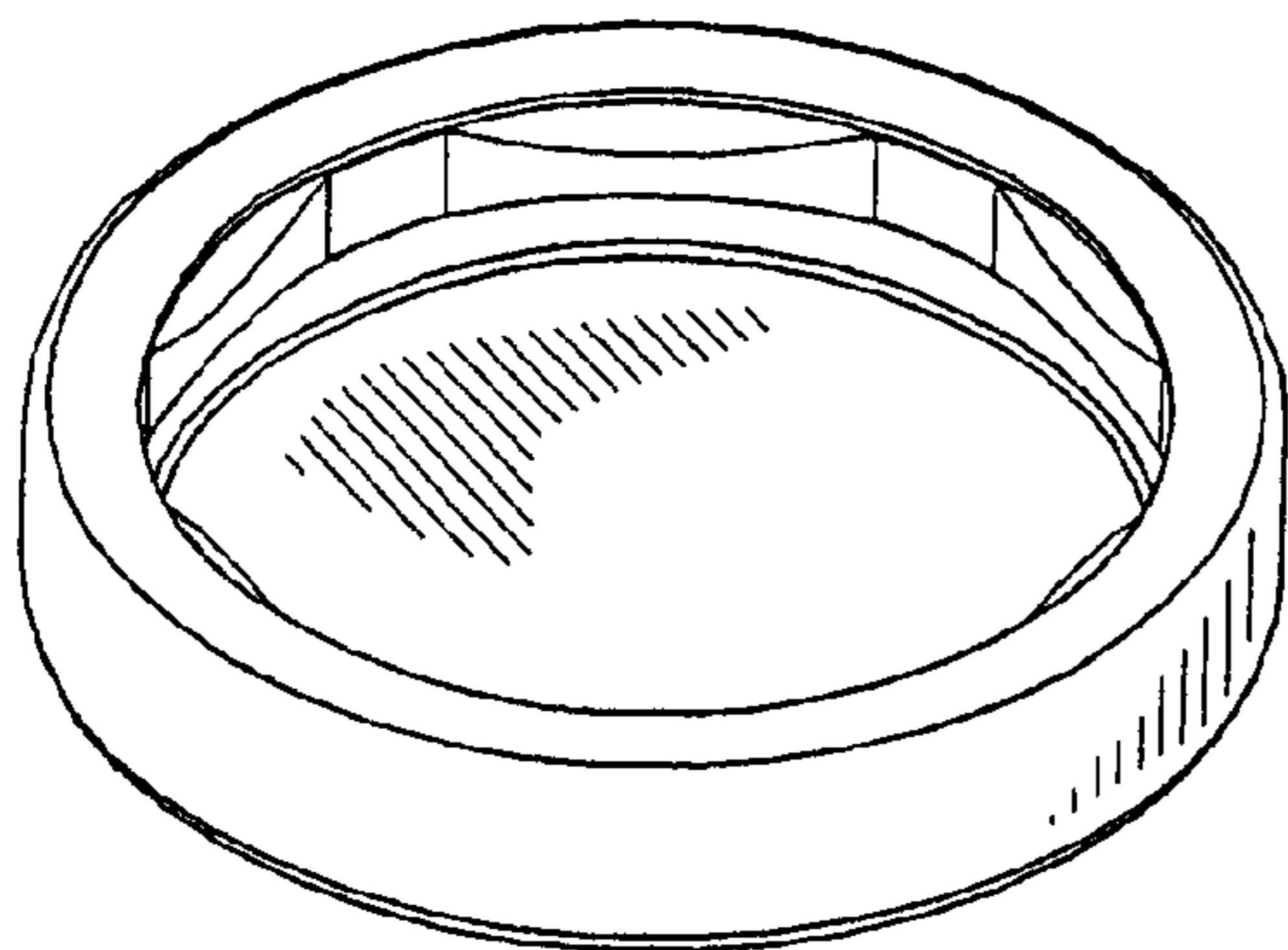
The ornamental design for a button, as shown and described.

**DESCRIPTION**

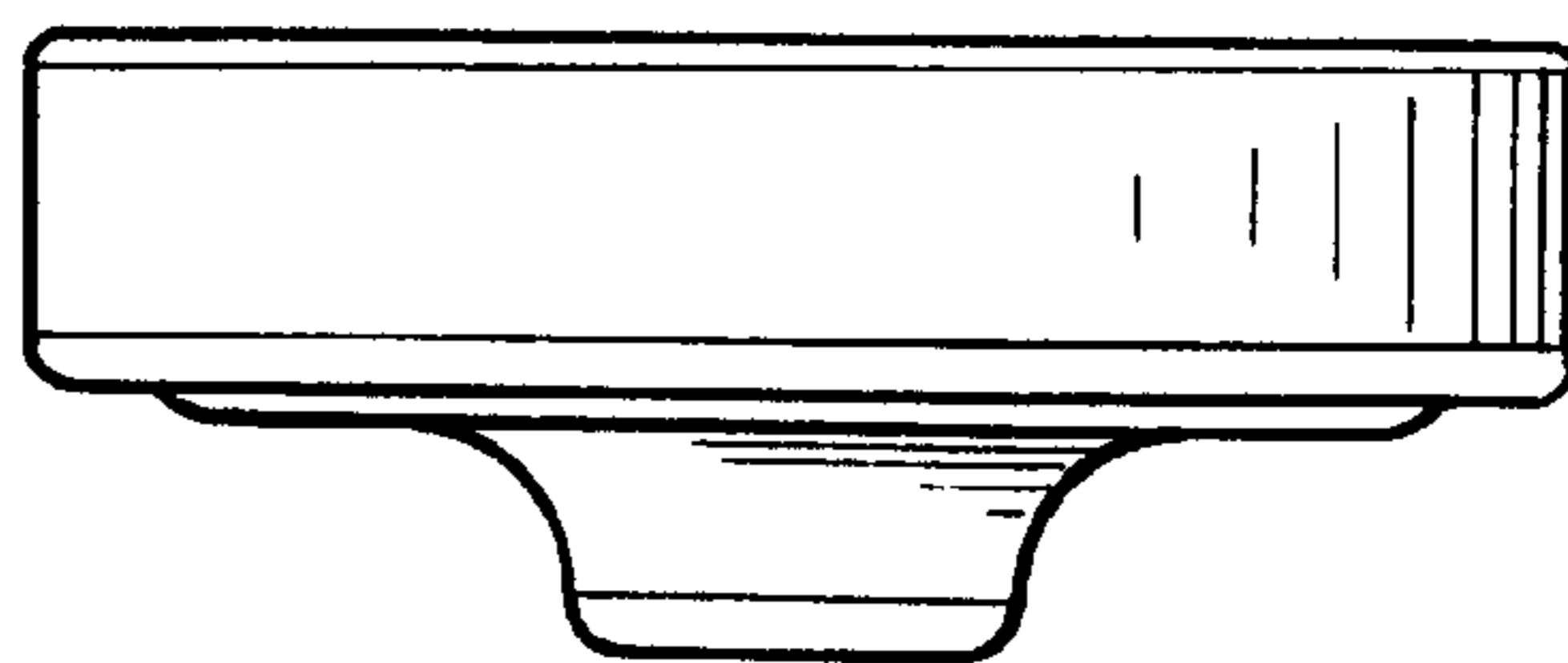
FIG. 1 is a perspective view of the female portion of a button showing my new design;  
FIG. 2 is a top plan view thereof;  
FIG. 3 is a bottom plan view thereof;  
FIG. 4 is a front elevation view, with the rear view, left side view and right side view being a mirror image thereof;  
FIG. 5 is a perspective view of the male portion of a button;  
FIG. 6 is a top plan view thereof;  
FIG. 7 is a bottom plan view; and,  
FIG. 8 is a front elevation view with the rear view, left side view and right side view being a mirror image thereof.

**1 Claim, 2 Drawing Sheets**

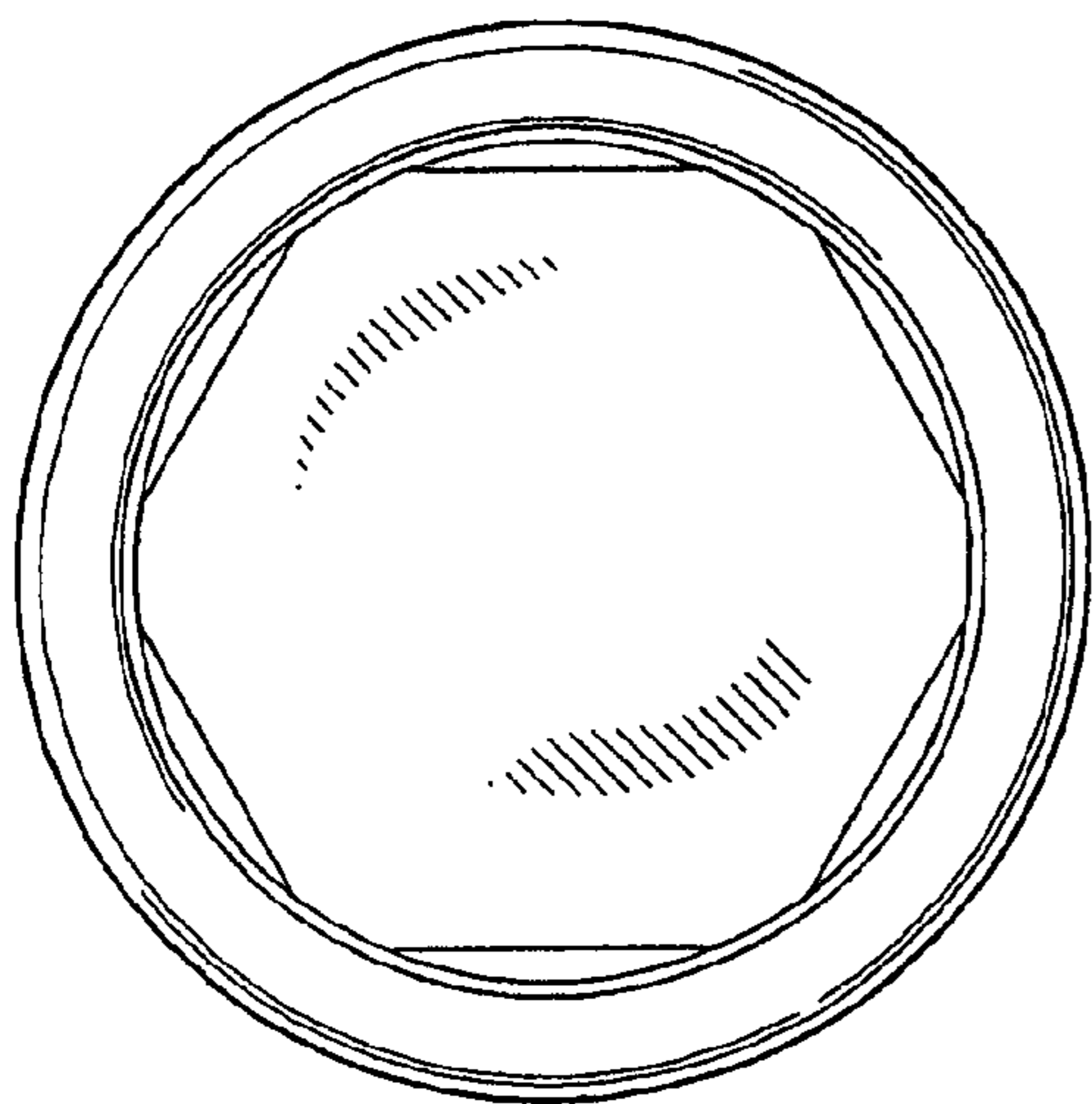




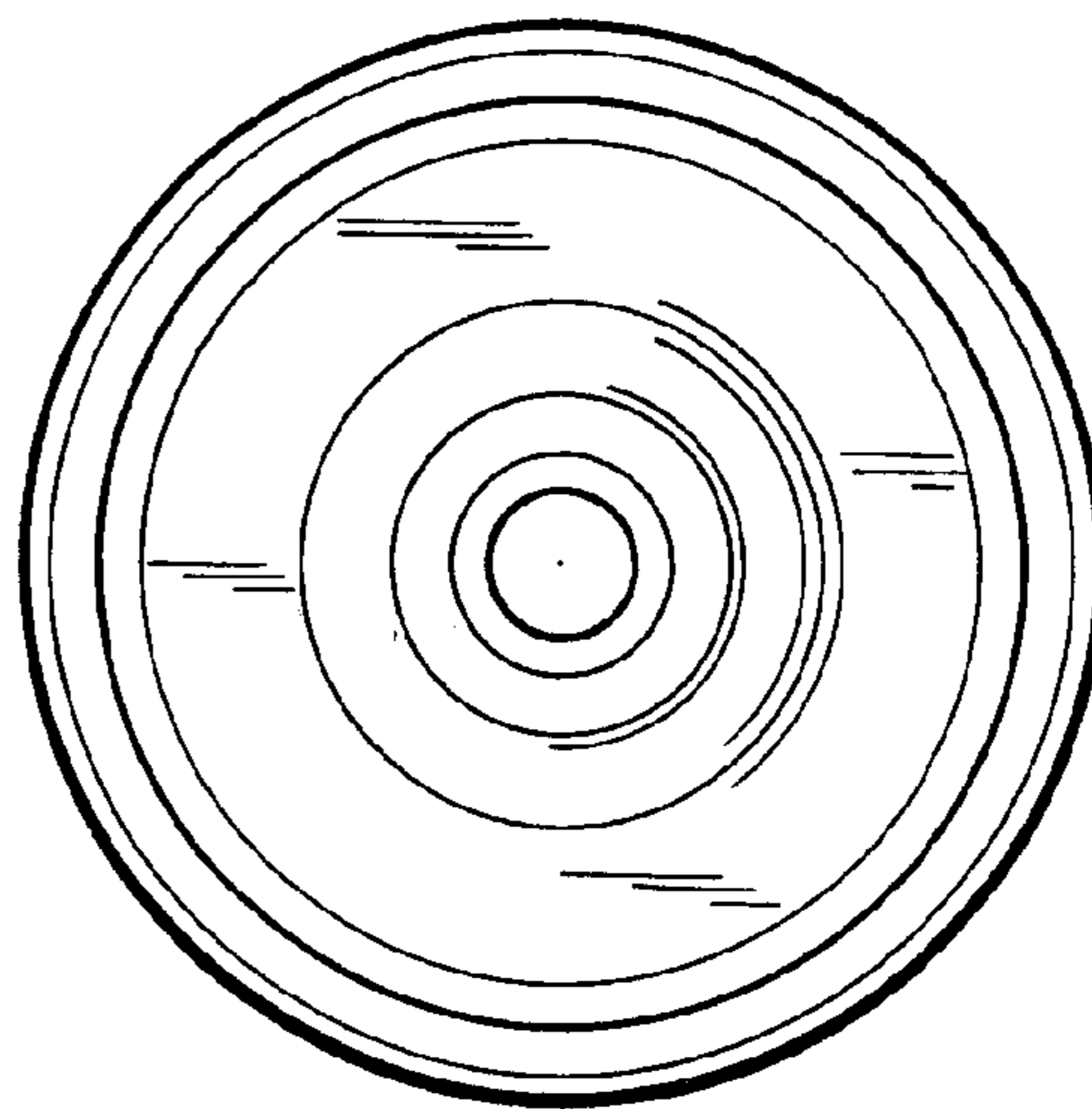
*Fig. 1*



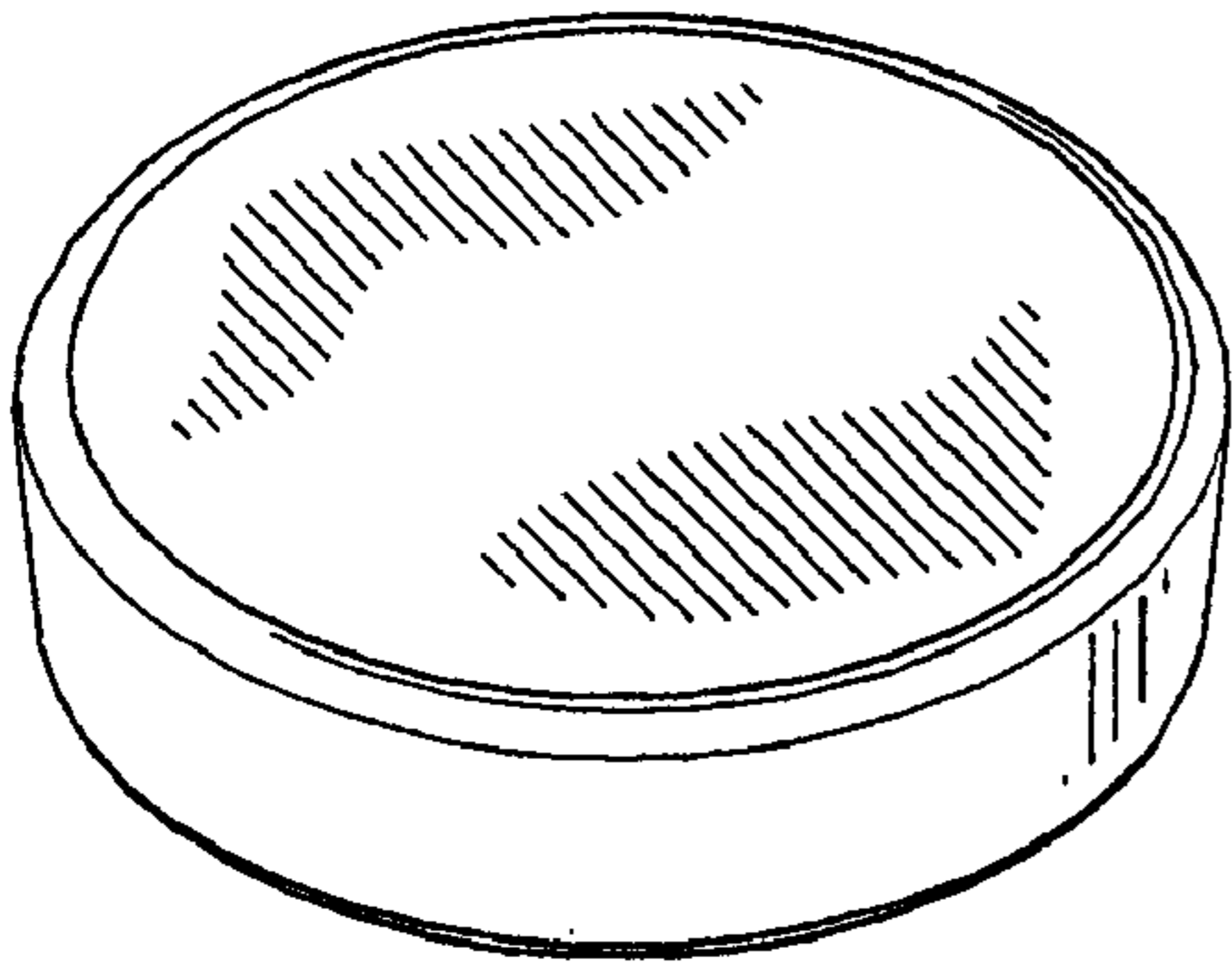
*Fig. 4*



*Fig. 2*

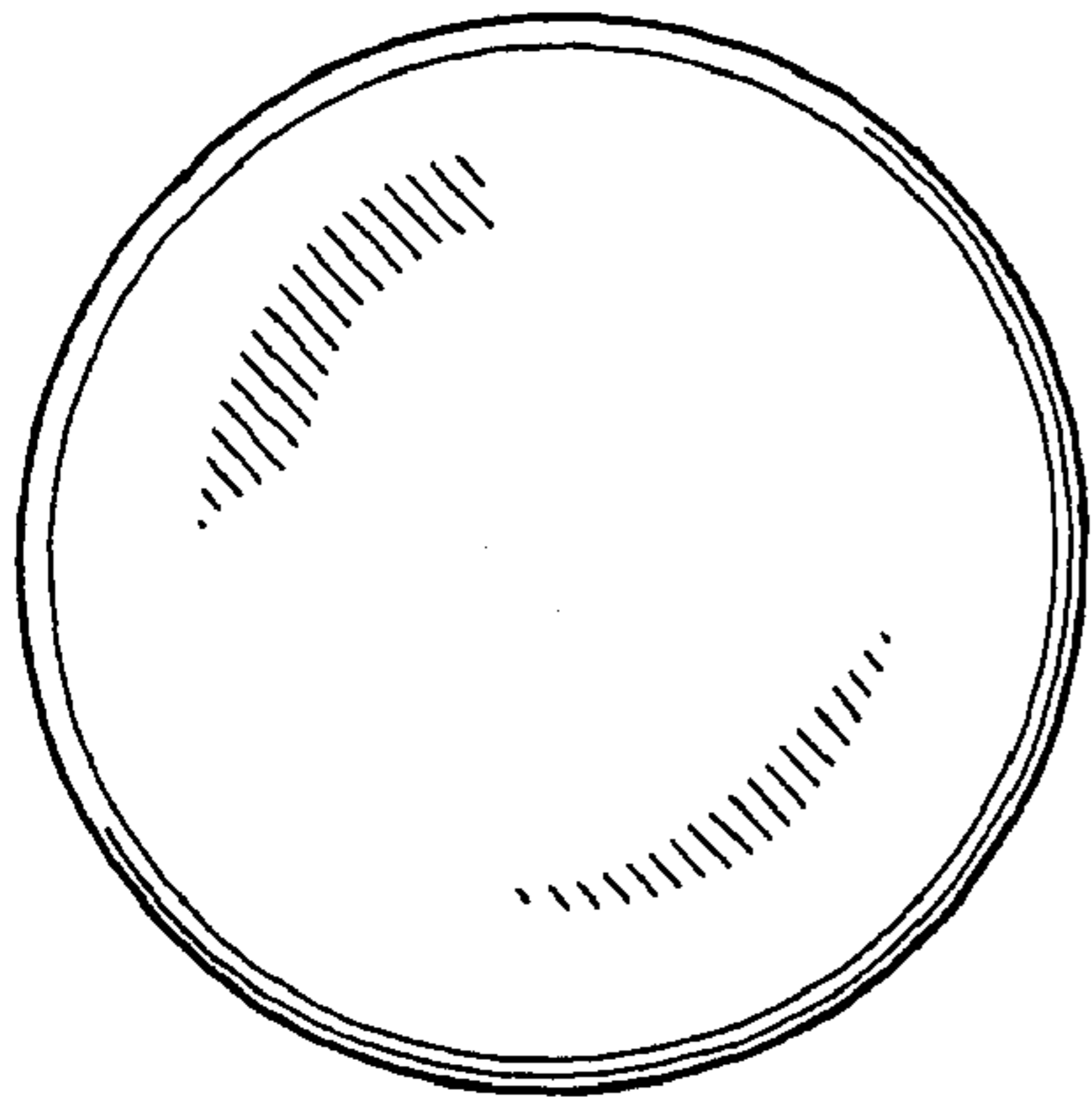
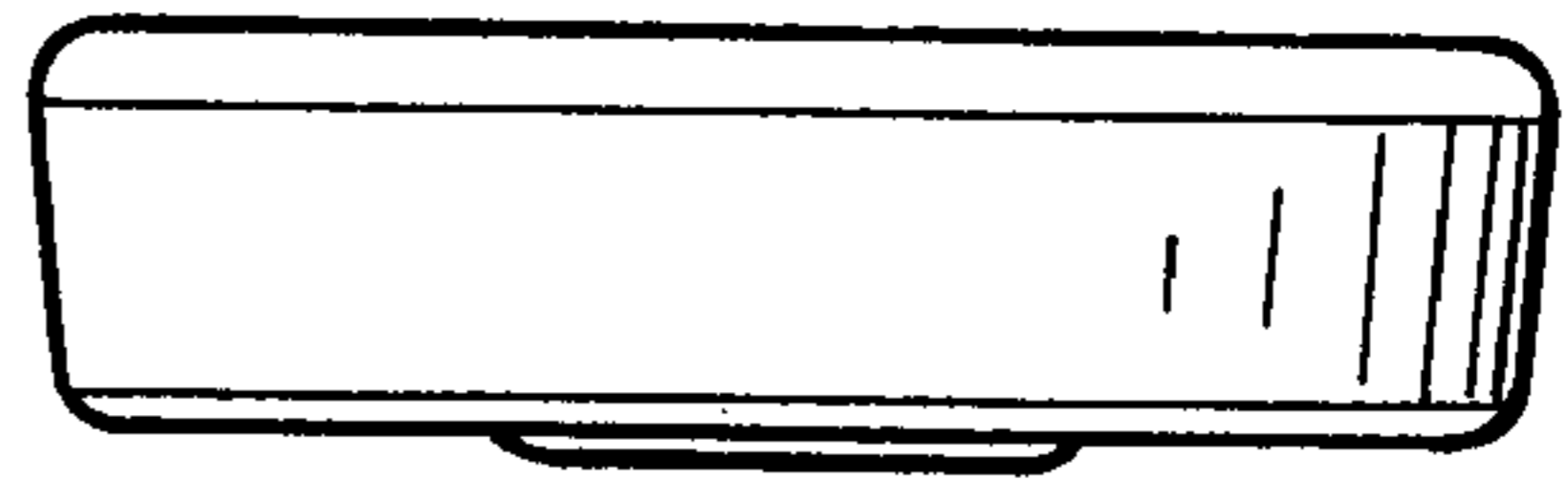


*Fig. 3*

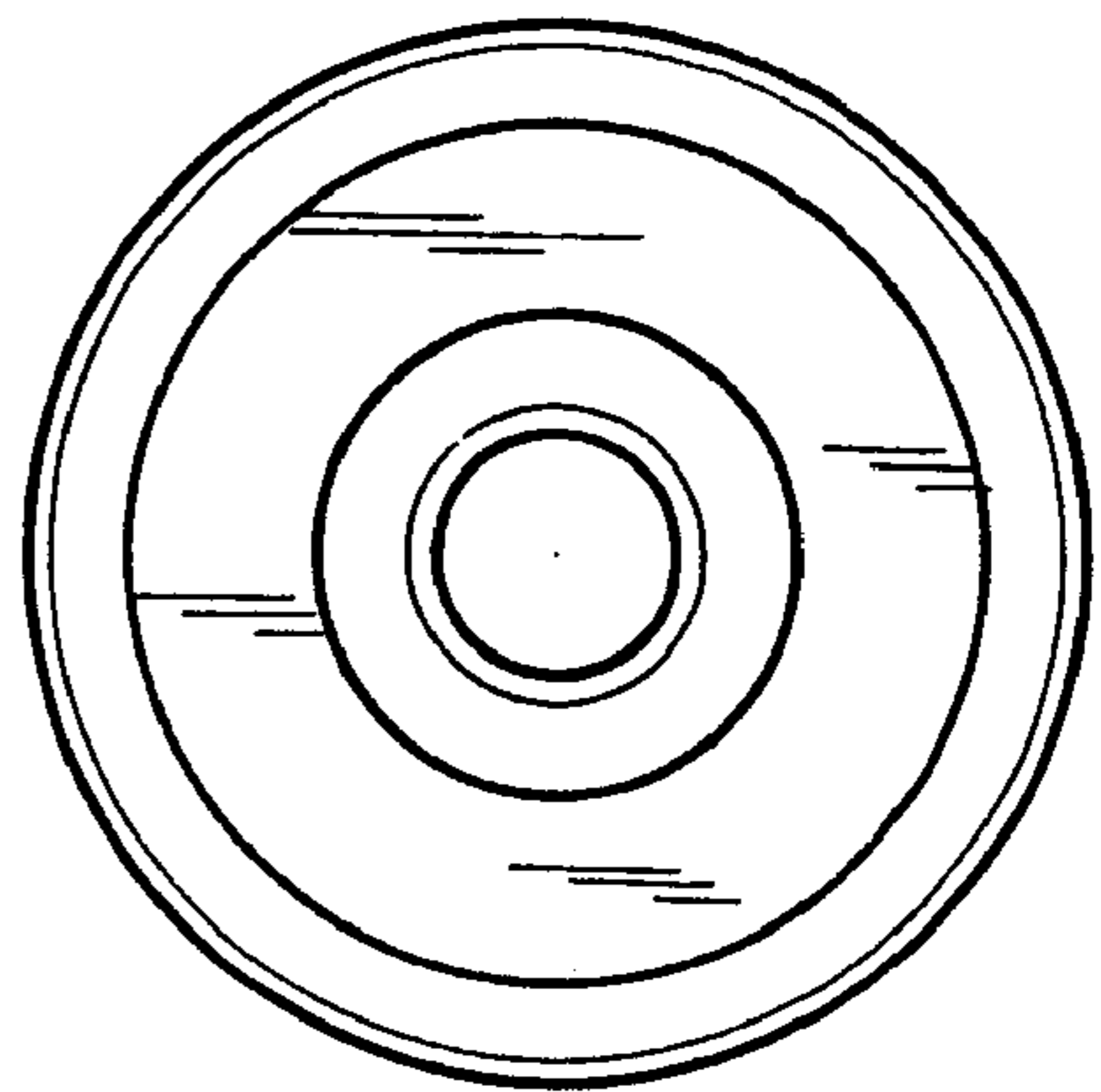


*Fig. 5*

*Fig. 8*



*Fig. 6*



*Fig. 7*