



US00D486042S

(12) **United States Design Patent**
Stolzenberg

(10) **Patent No.:** **US D486,042 S**

(45) **Date of Patent:** **** Feb. 3, 2004**

(54) **PLANT ROTATOR**

D343,776 S * 2/1994 Johnson D8/7

(76) **Inventor:** **Peter Stolzenberg**, 808 De Kelb Pike,
Gwynedd Valley, PA (US) 19437

* cited by examiner

(**) **Term:** **14 Years**

Primary Examiner—Holly Baynham

(74) *Attorney, Agent, or Firm*—Zachary T. Wobensmith, III

(21) **Appl. No.:** **29/182,969**

(57) **CLAIM**

(22) **Filed:** **Jun. 5, 2003**

The ornamental design for a plant rotator, as shown and described.

(51) **LOC (7) Cl.** **08-01**

DESCRIPTION

(52) **U.S. Cl.** **D8/7**

(58) **Field of Search** D8/7; 47/48.5,
47/40.5, 81, 73; 172/371

FIG. 1 is a side elevational view of a plant rotator, showing my design;

FIG. 2 is a top plan view there of;

FIG. 3 is a side elevational view thereof.

FIG. 4 is a bottom plan view thereof;

FIG. 5 is a top perspective view thereof; and,

FIG. 6 is a bottom perspective view thereof.

(56) **References Cited**

U.S. PATENT DOCUMENTS

D89,682 S * 4/1933 Croasdale, Jr. et al. D8/7

D222,658 S * 11/1971 Carlson D8/7

4,282,684 A * 8/1981 McLellan 111/101

1 Claim, 2 Drawing Sheets

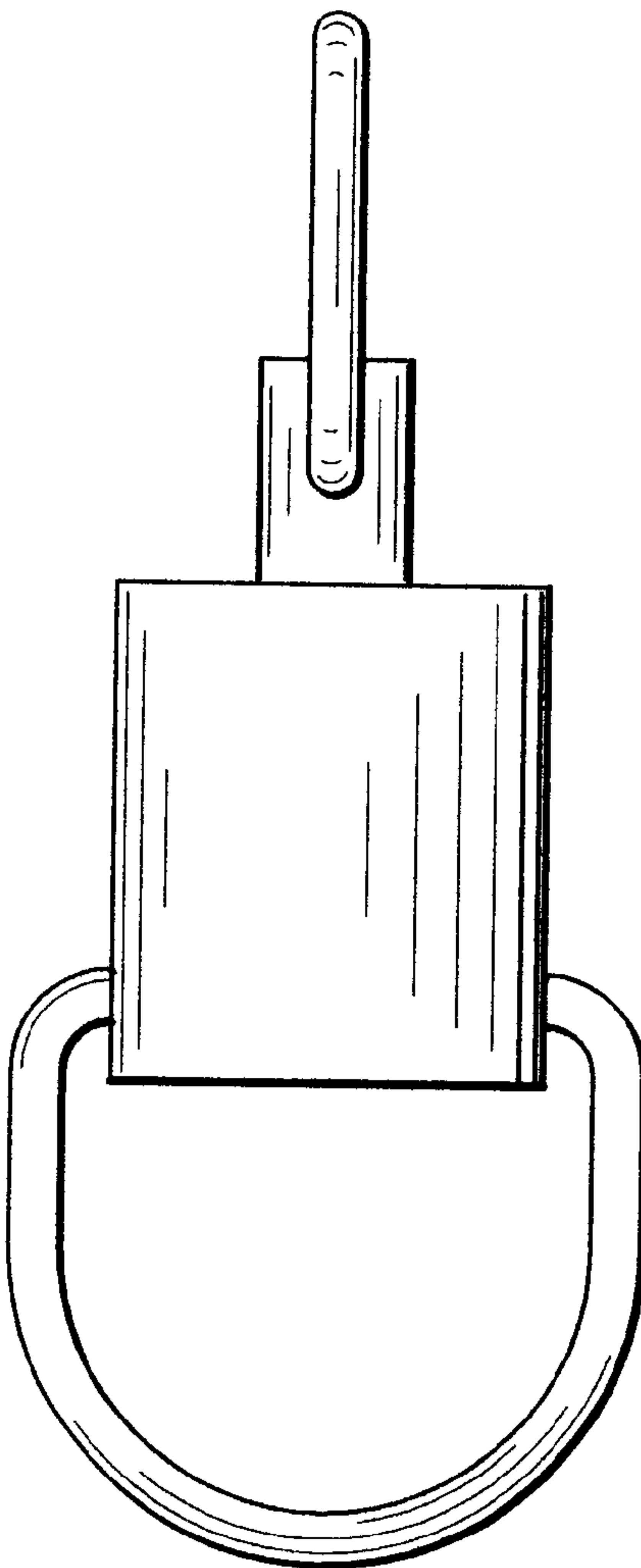

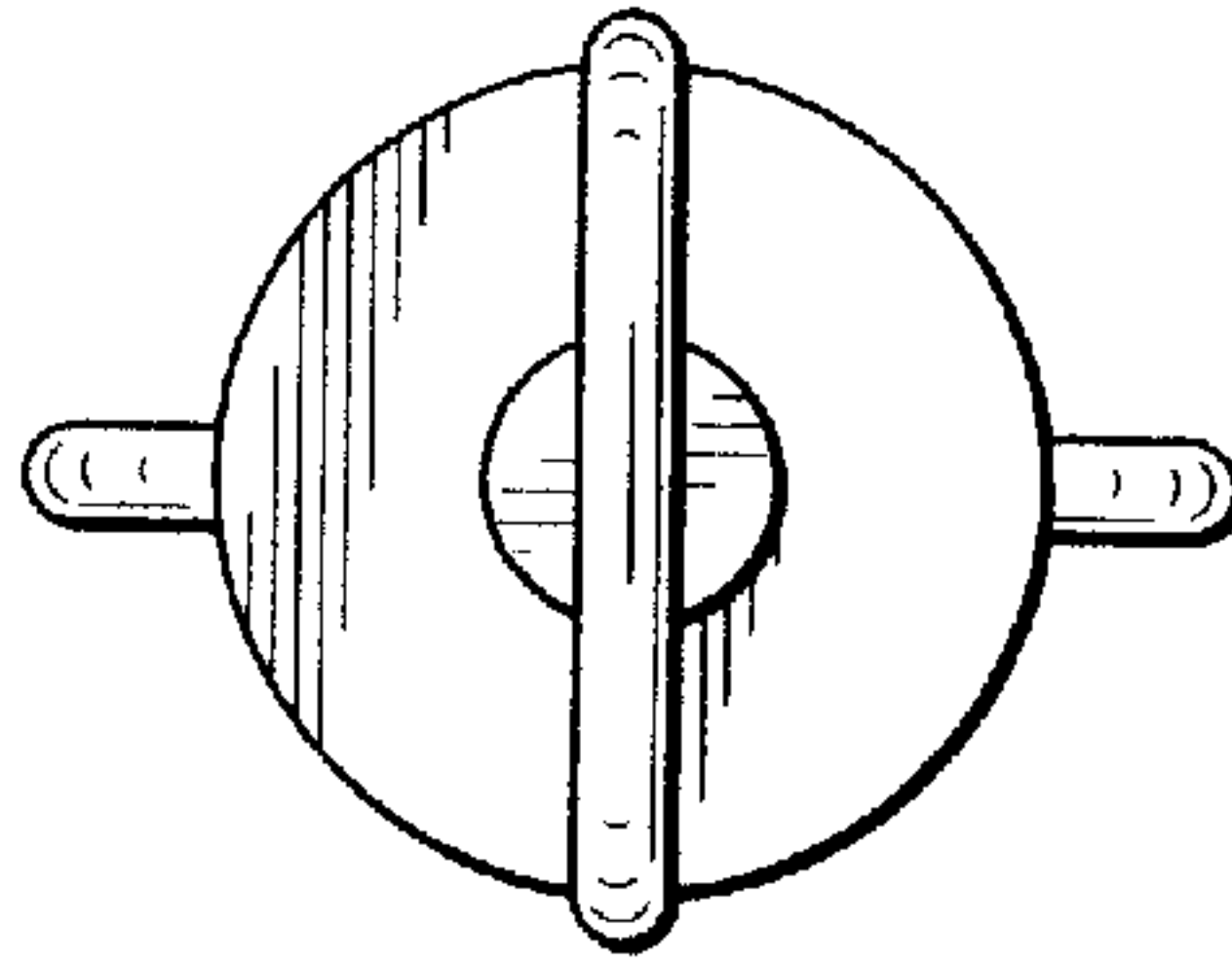

Fig. 2

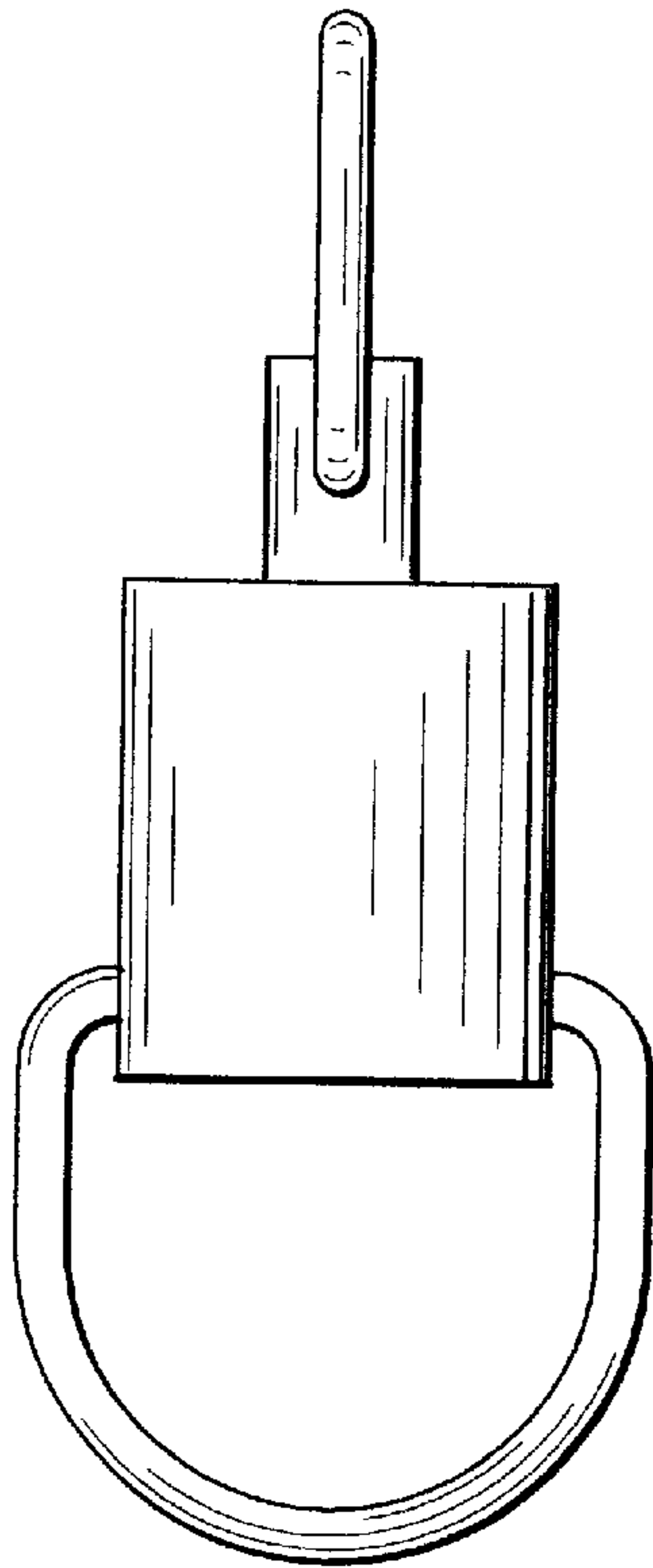

Fig. 1

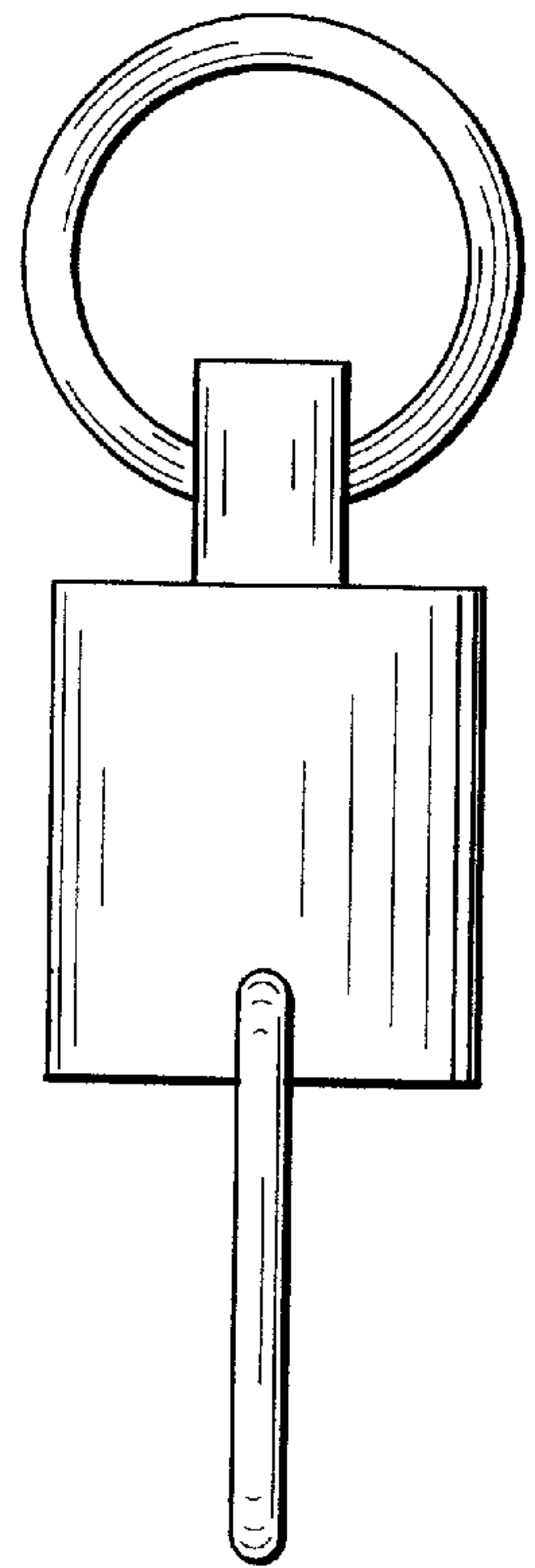

Fig. 3

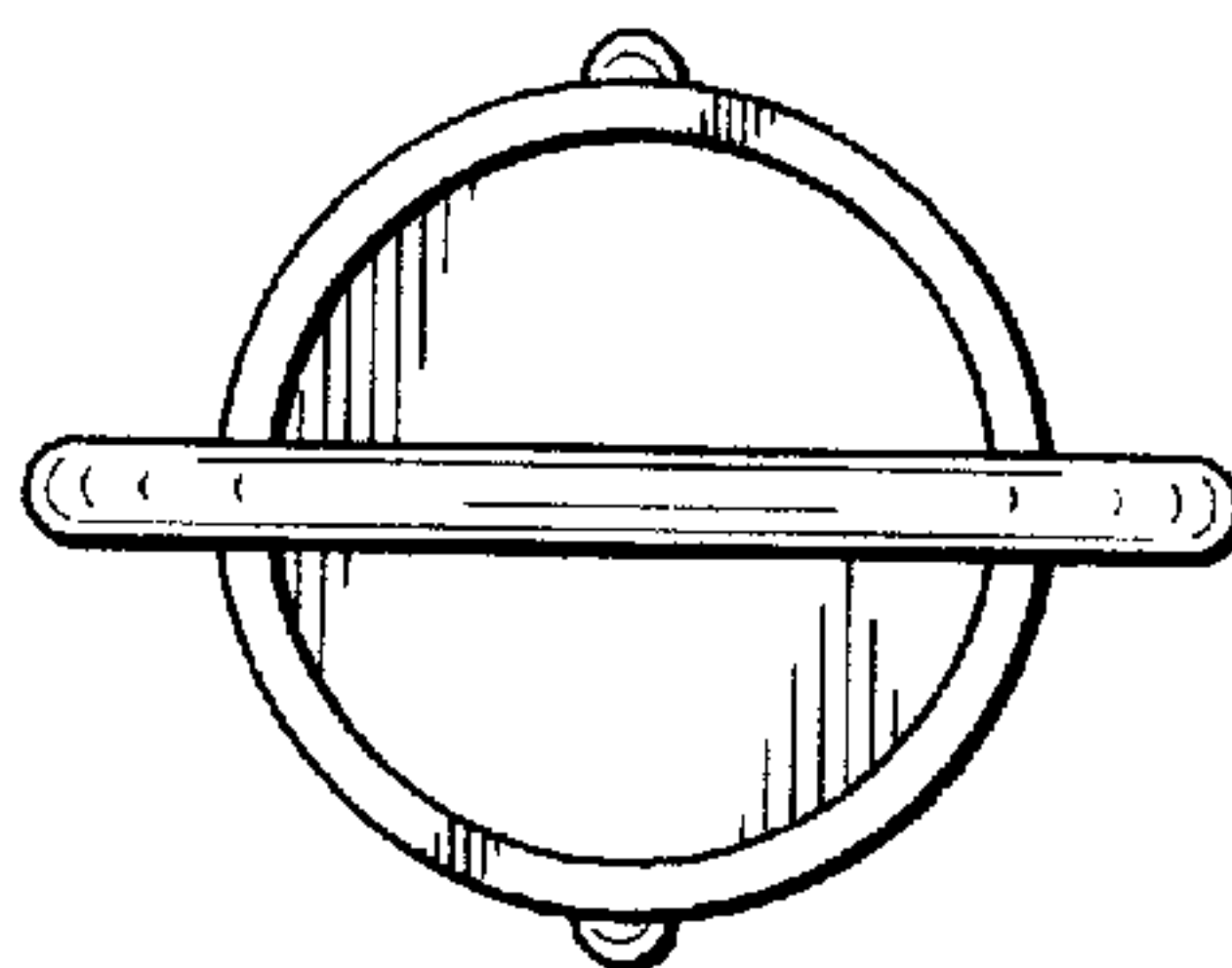

Fig. 4

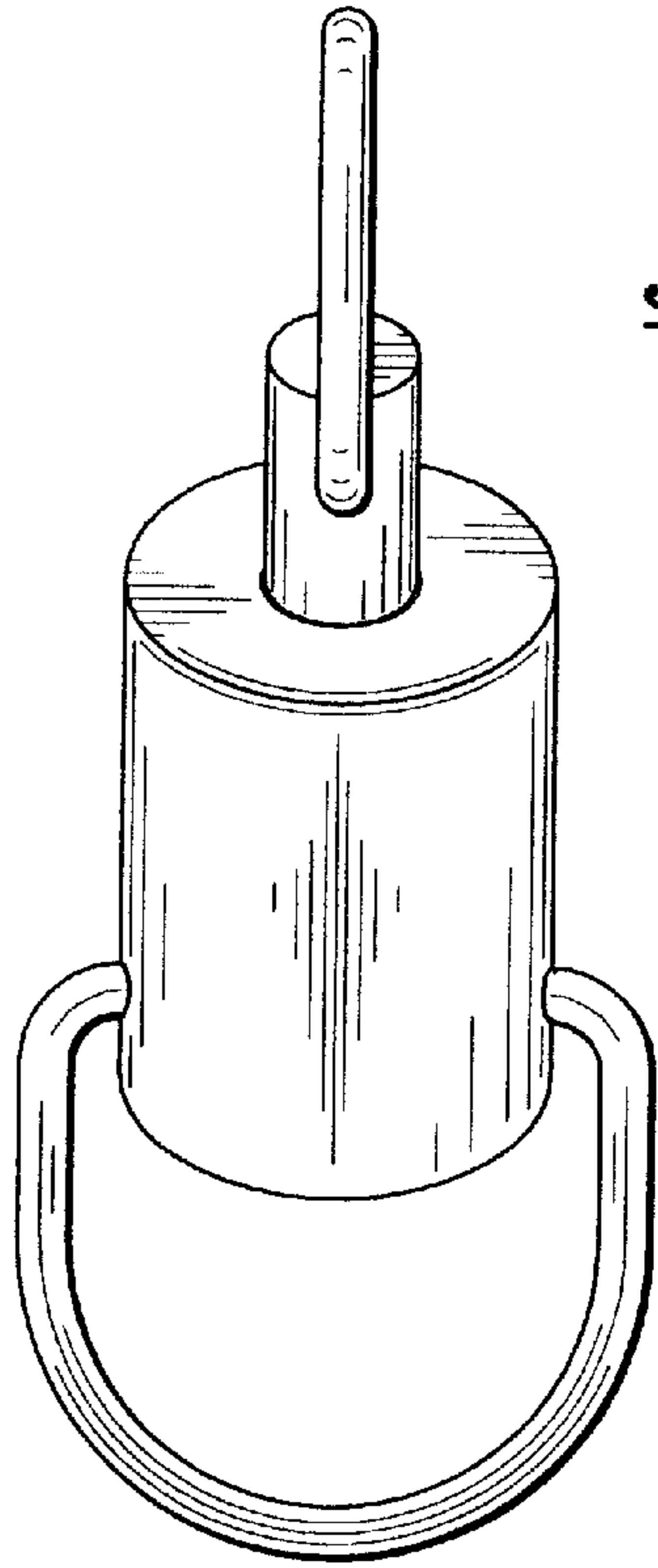

Fig. 5

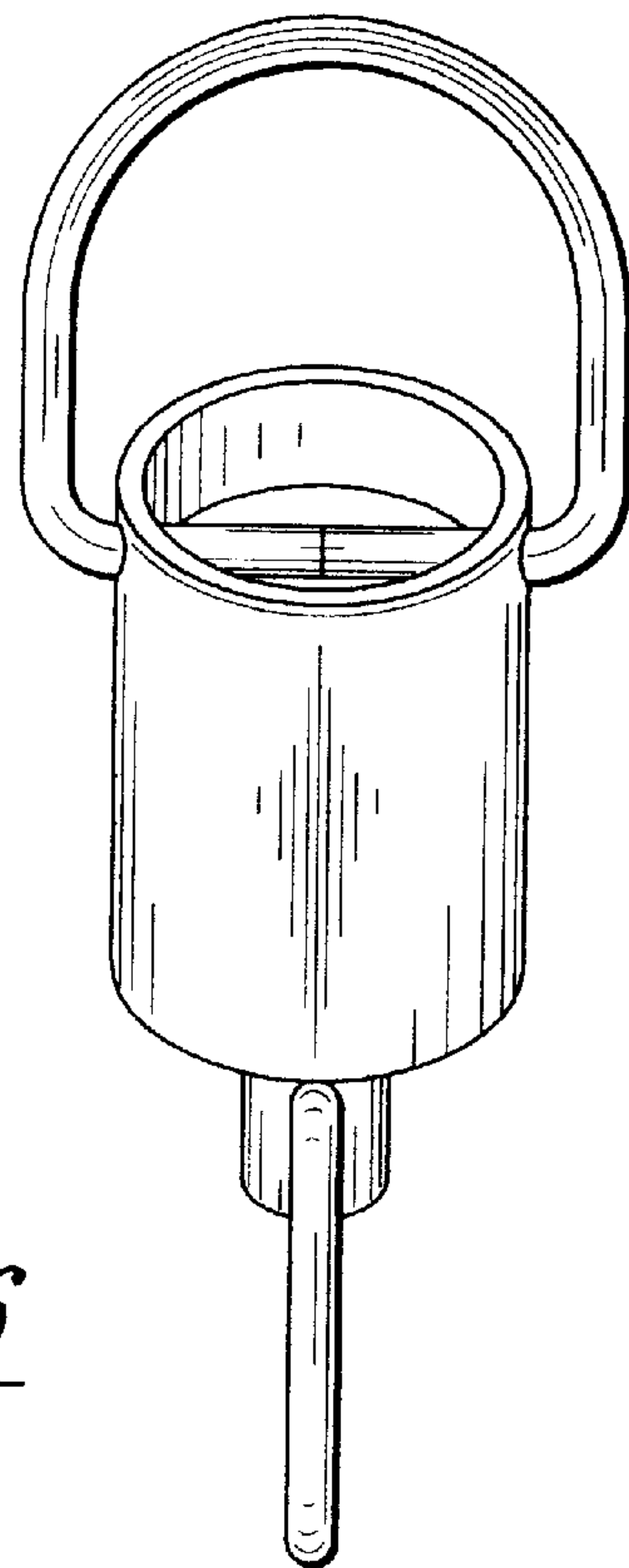

Fig. 6