



US00D486030S

(12) **United States Design Patent**  
**Bergh**

(10) **Patent No.:** **US D486,030 S**

(45) **Date of Patent:** **\*\* Feb. 3, 2004**

(54) **WALLET FOR COMPACT DISCS**

(75) Inventor: **James Allen Bergh**, Boulder, CO (US)

(73) Assignee: **Case Logic, Inc.**, Longmont, CO (US)

(\*\*) Term: **14 Years**

(21) Appl. No.: **29/159,649**

(22) Filed: **Apr. 24, 2002**

(51) **LOC (7) Cl.** ..... **03-01**

(52) **U.S. Cl.** ..... **D6/632; D6/407; D3/301**

(58) **Field of Search** ..... **D3/218, 301, 289;**  
**D6/632, 633, 631; 206/308.1, 308.2, 310**

(56) **References Cited**

**U.S. PATENT DOCUMENTS**

D383,620 S	*	9/1997	Smith et al.	.....	D6/407
D386,014 S	*	11/1997	Chen	.....	D6/407
D393,947 S		5/1998	Alves et al.	.....	D3/303
D403,915 S		1/1999	Temple et al.	.....	D6/631
D427,766 S	*	7/2000	Hillman	.....	D3/218
D434,938 S	*	12/2000	Hillman	.....	D6/633
6,186,321 B1	*	2/2001	Eskandry	.....	206/308.1
D455,930 S	*	4/2002	Eskandry	.....	D6/631
D459,887 S	*	7/2002	Johnson	.....	D3/303
D460,261 S	*	7/2002	Fair	.....	D3/301

**OTHER PUBLICATIONS**

Case Logic, Computer Product Catalog 1996, 3 pgs.

Case Logic, Essential Equipment 2001, pp. 5-9, 13, 21, 27, 29 and 31.

Case Logic, Product Catalog Spring 2000, pp. 6-9.

\* cited by examiner

*Primary Examiner*—Philip S. Hyder

(74) *Attorney, Agent, or Firm*—Sheridan Ross P.C.

(57) **CLAIM**

The ornamental design for a wallet for compact discs, shown and described.

**DESCRIPTION**

FIG. 1 is a front perspective view of a wallet for compact discs, showing my new design, the broken lines depicting environment and forming no part of the claimed design;

FIG. 2 is a top perspective view of the invention illustrated in FIG. 1 shown in an open position, the broken lines depicting environment and forming no part of the claimed design;

FIG. 3 is a front elevation view of the invention illustrated in FIG. 1;

FIG. 4 is a rear elevation view of the invention illustrated in FIG. 1;

FIG. 5 is a left elevation view of the invention illustrated in FIG. 1;

FIG. 6 is a right elevation view of the invention illustrated in FIG. 1;

FIG. 7 is a top plan view of the invention illustrated in FIG. 1; and,

FIG. 8 is a bottom plan view of the invention illustrated in FIG. 1.

**1 Claim, 4 Drawing Sheets**

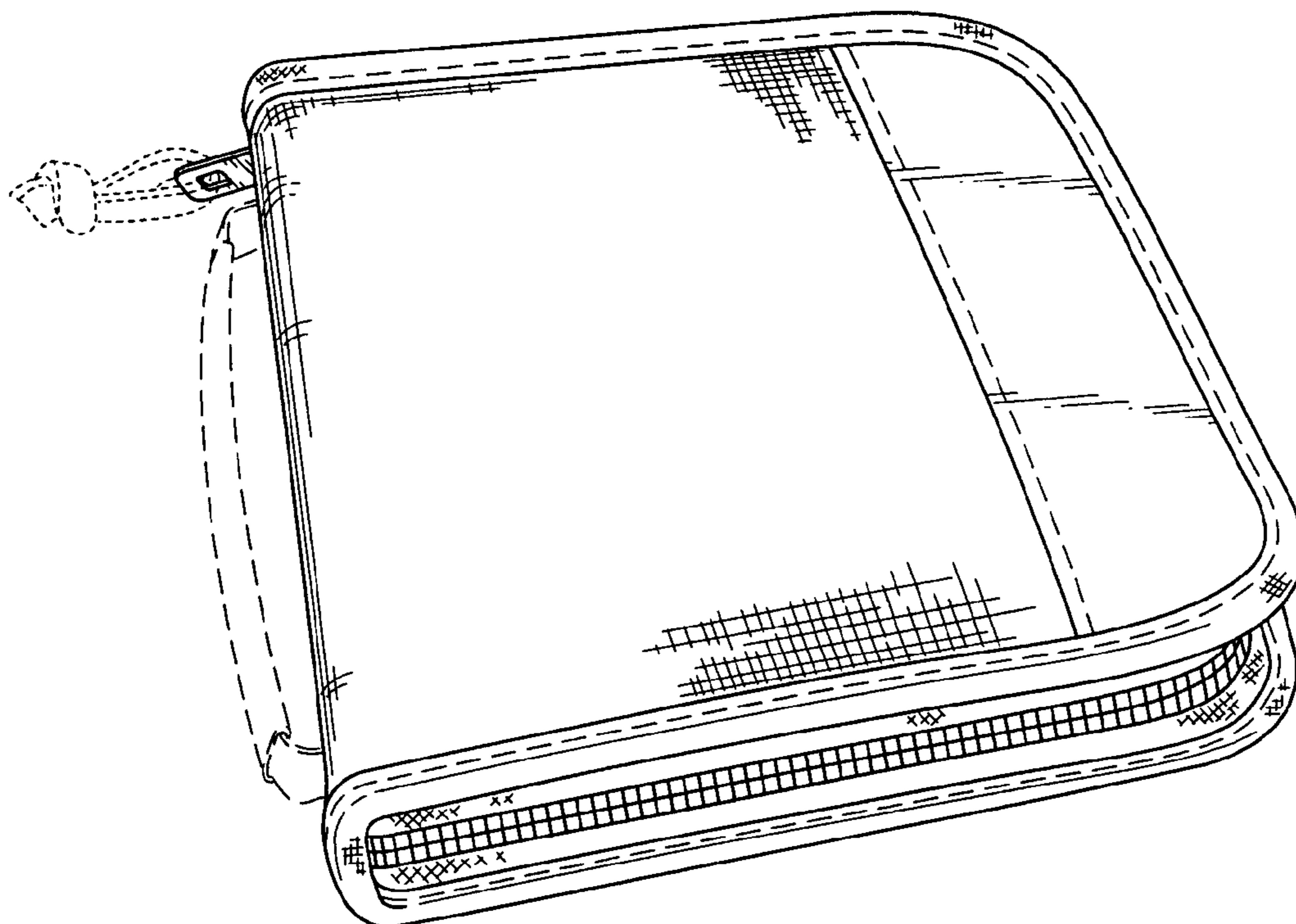

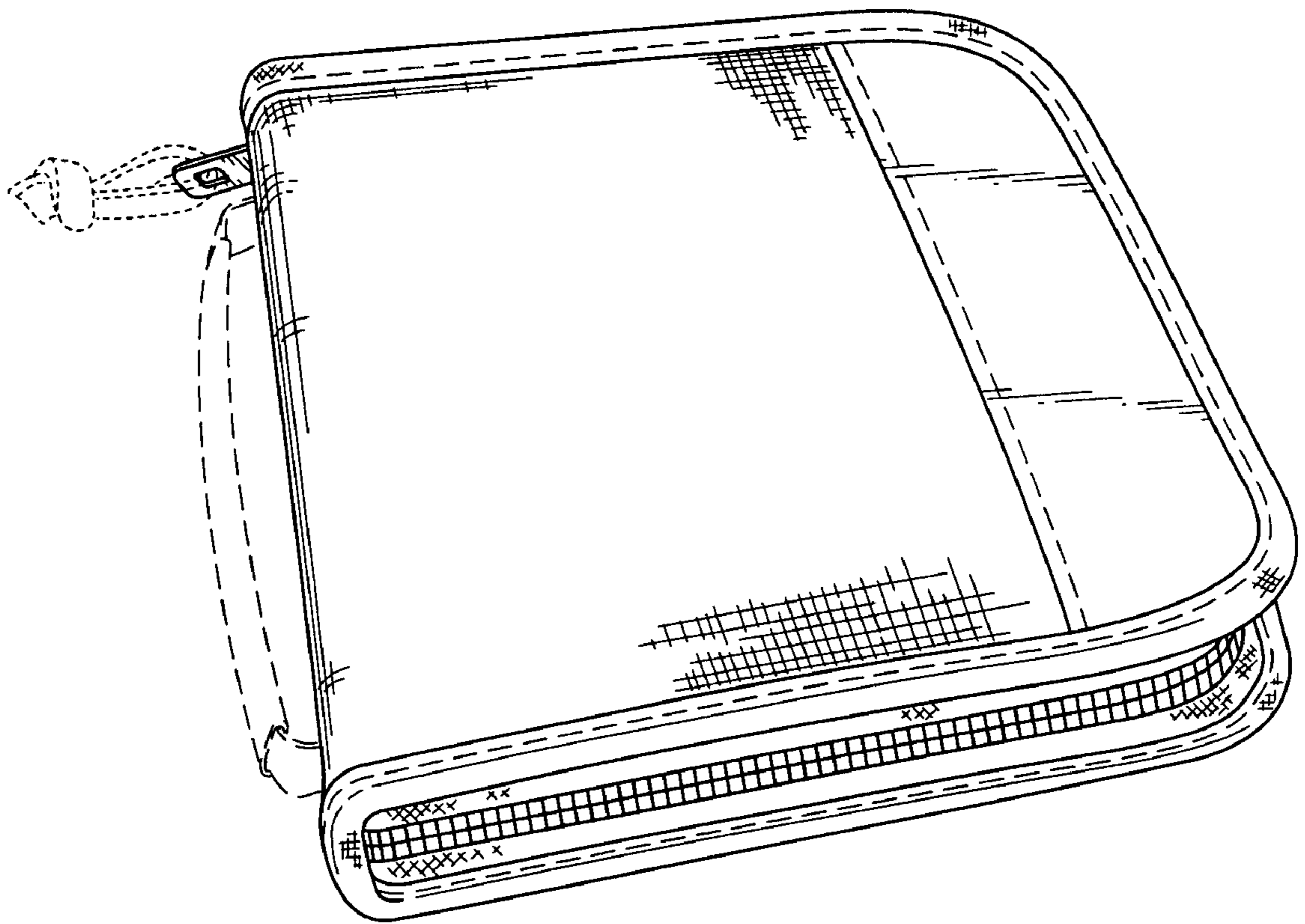

FIG.1

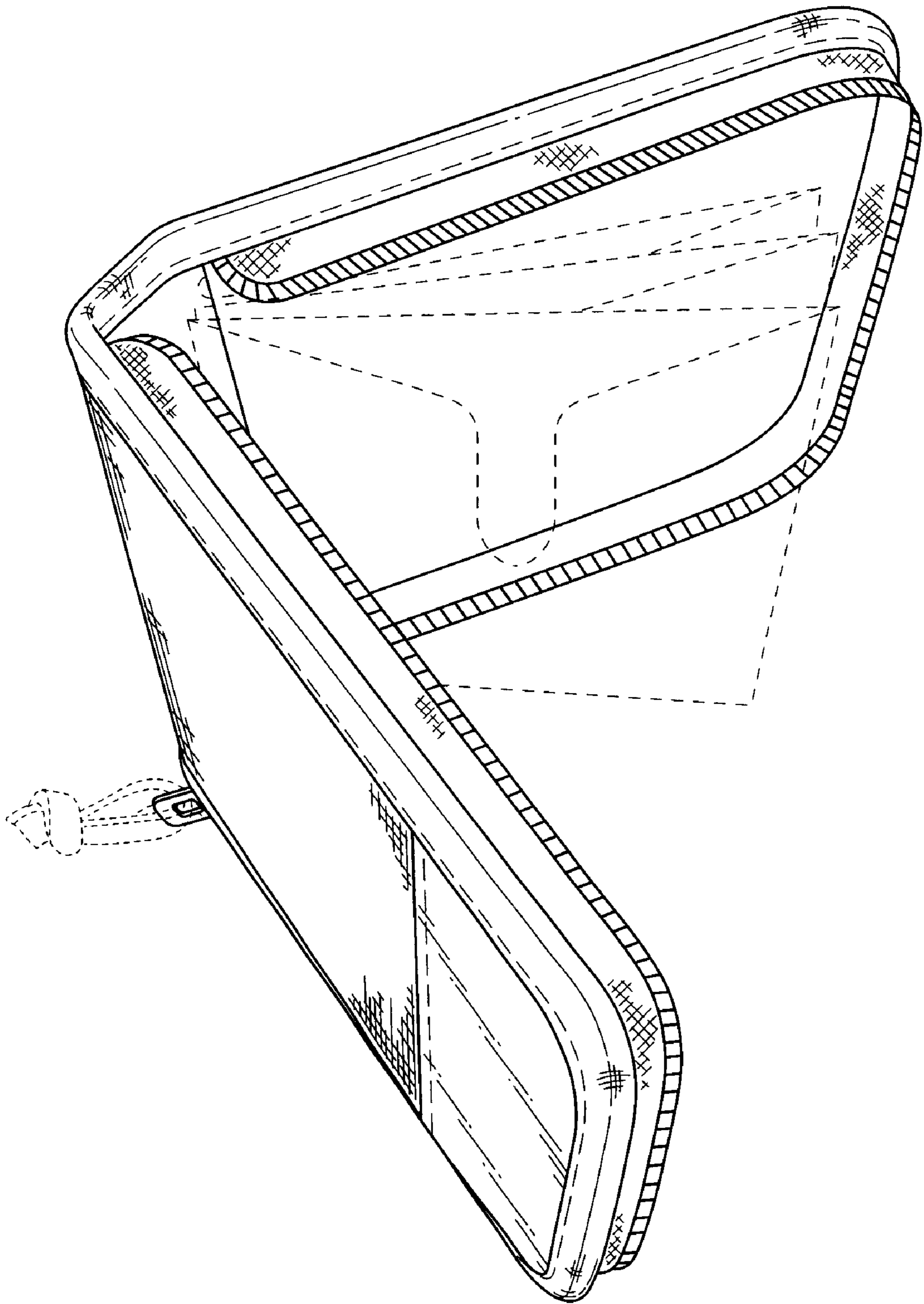

FIG.2

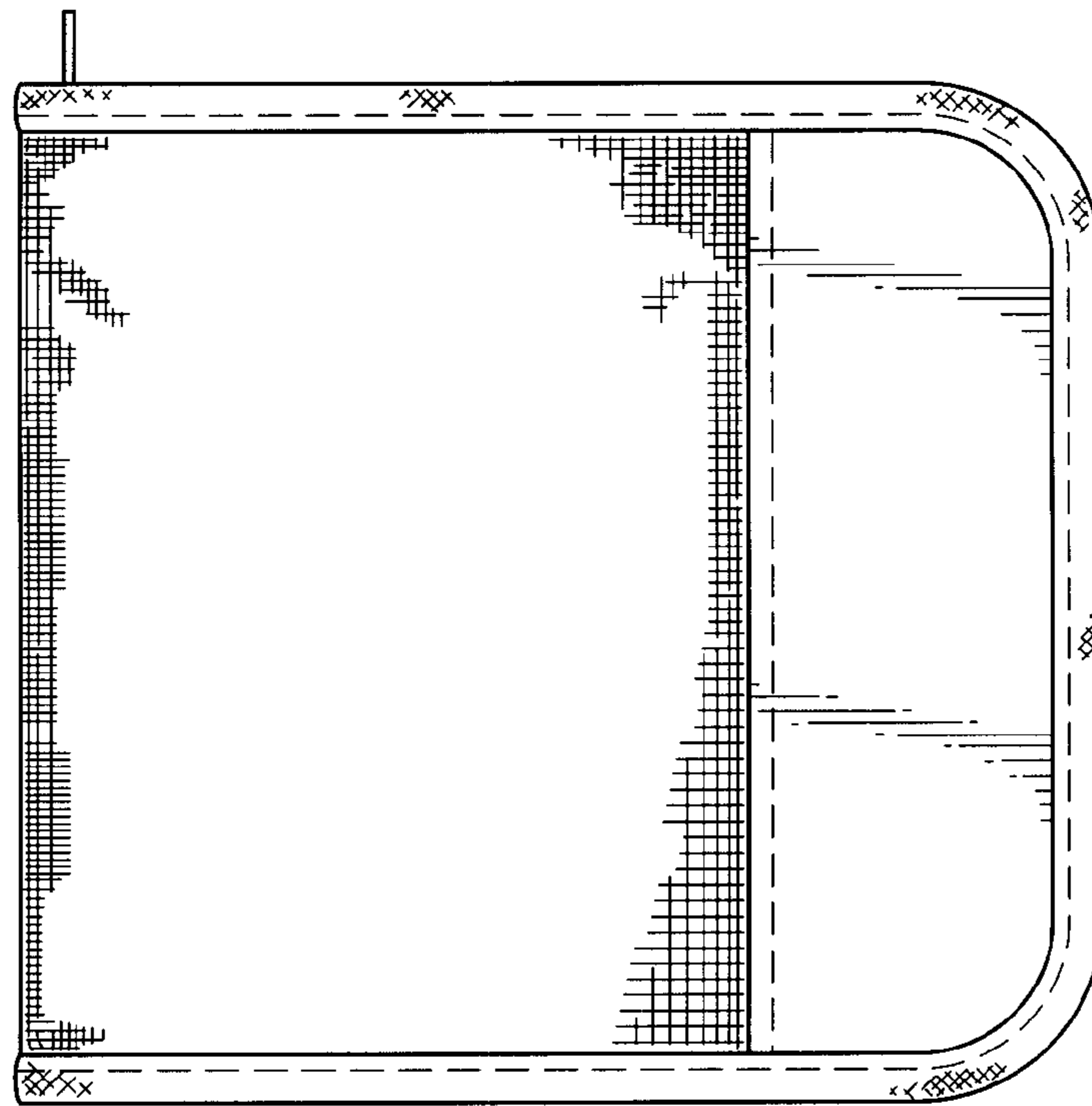

FIG.3

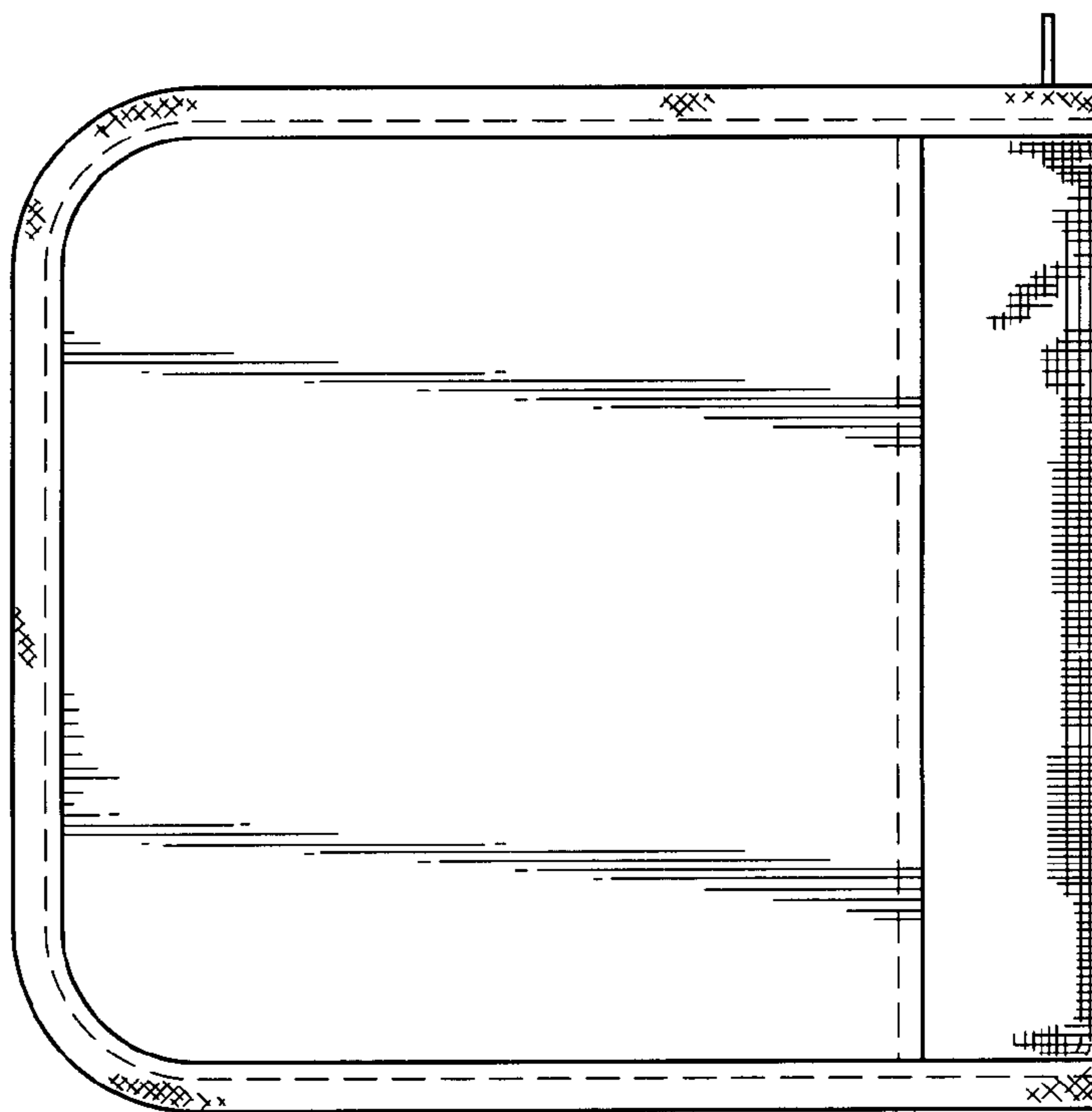

FIG.4

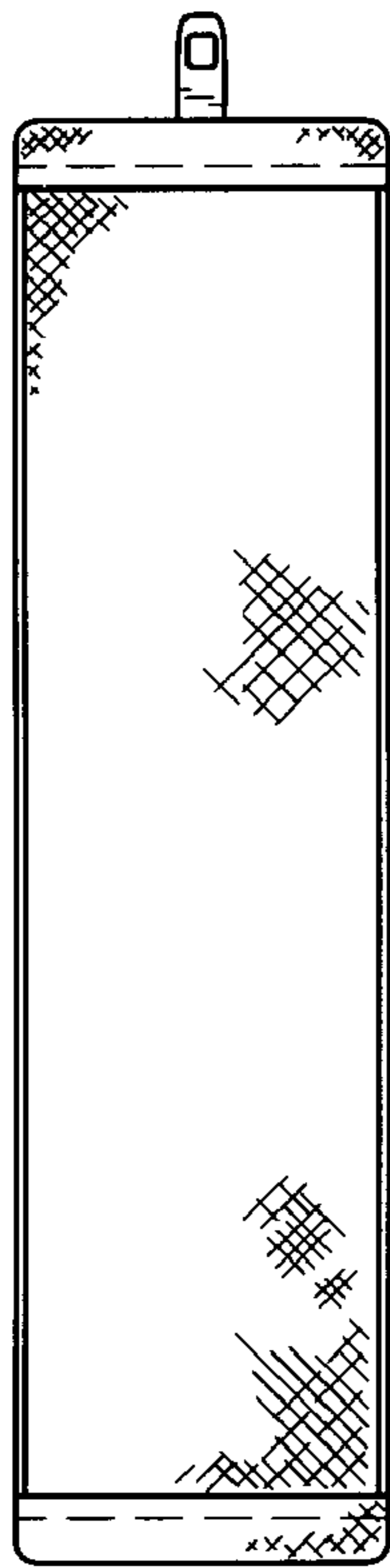

FIG. 5

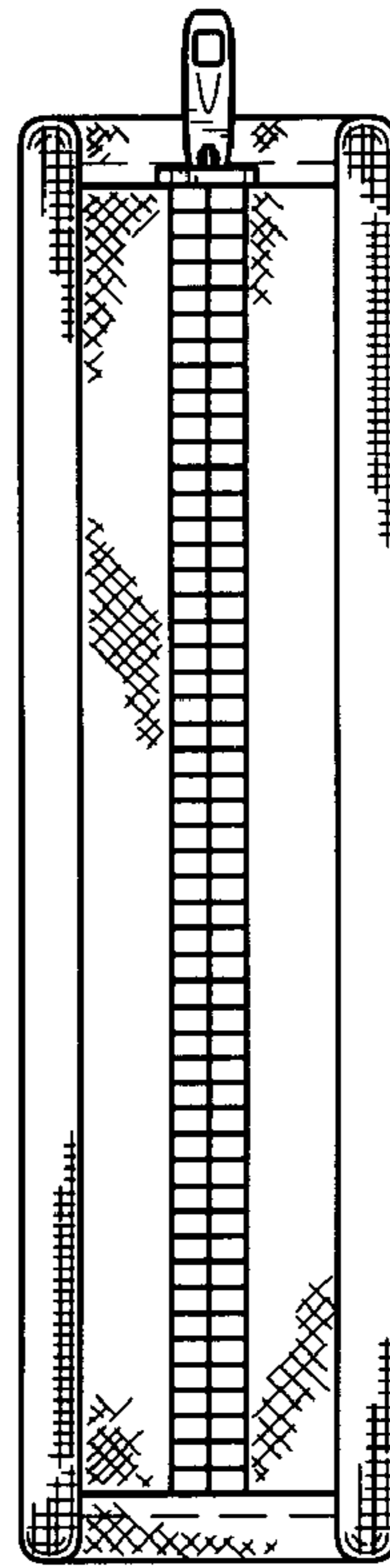

FIG. 6

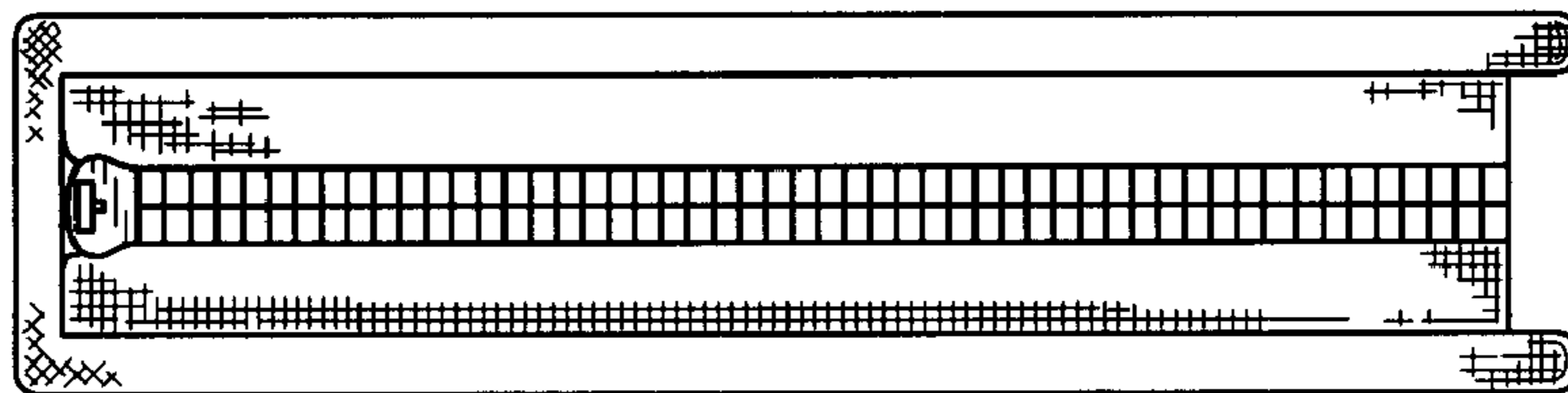

FIG. 7

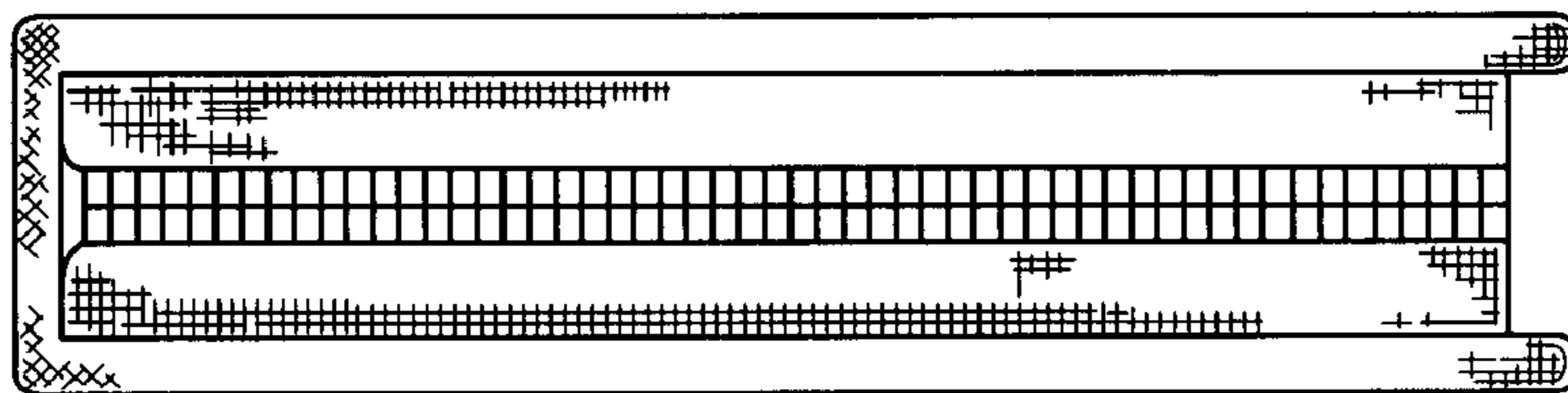

FIG. 8