



US00D486025S

(12) **United States Design Patent** (10) **Patent No.:** **US D486,025 S**
Ahrens (45) **Date of Patent:** **** Feb. 3, 2004**

(54) **CORNICE ATTACHMENT**

(76) Inventor: **Theodore W. Ahrens**, 2520 Otter Creek La., Elgin, IL (US) 60123

(**) Term: **14 Years**

(21) Appl. No.: **29/173,042**

(22) Filed: **Dec. 23, 2002**

(51) **LOC (7) Cl.** **06-10**

(52) **U.S. Cl.** **D6/579; D6/580**

(58) **Field of Search** **D6/578-580; 160/19, 160/38, 178.1 R, 178.1 V, 168.1 V**

(56) **References Cited**

U.S. PATENT DOCUMENTS

238,527 A	3/1881	Replogle	
24,282 A	5/1895	Hoort	
1,199,673 A	9/1916	Donovan	
2,565,588 A *	8/1951	Bruno	160/39
2,602,500 A *	7/1952	Slavin et al.	160/38
5,217,784 A *	6/1993	Shepherd	428/99
D393,771 S *	4/1998	Saffels	D6/579
D439,459 S *	3/2001	Ohanesian	D6/579

* cited by examiner

Primary Examiner—Robin V. Taylor

(74) *Attorney, Agent, or Firm*—Richard C. Litman

(57) **CLAIM**

The ornamental design for a cornice attachment, as shown and described.

DESCRIPTION

FIG. 1 is an environmental perspective view of a first

embodiment of a cornice attachment showing my new design;

FIG. 2 is an environmental front elevational view thereof;

FIG. 3 is an environmental right side elevational view with the left side being a mirror image thereof;

FIG. 4 is a bottom view thereof;

FIG. 5 is an environmental rear elevational view thereof;

FIG. 6 is an environmental perspective view of a second embodiment thereof;

FIG. 7 is an environmental front elevational view thereof;

FIG. 8 is an environmental right side elevational view with the left side being a mirror image thereof;

FIG. 9 is a bottom view thereof;

FIG. 10 is an environmental rear elevational view thereof;

FIG. 11 is an environmental perspective view of a third embodiment thereof;

FIG. 12 is an environmental front elevational view thereof;

FIG. 13 is an environmental right side elevational view with the left side being a mirror image thereof;

FIG. 14 is a bottom view thereof; and,

FIG. 15 is an environmental rear elevational view thereof.

The broken line showing of the molding in FIGS. 1-15 is to show the type of molding that can be used with the present design and is for illustrative purposes only and forms no part of the claimed design.

1 Claim, 15 Drawing Sheets

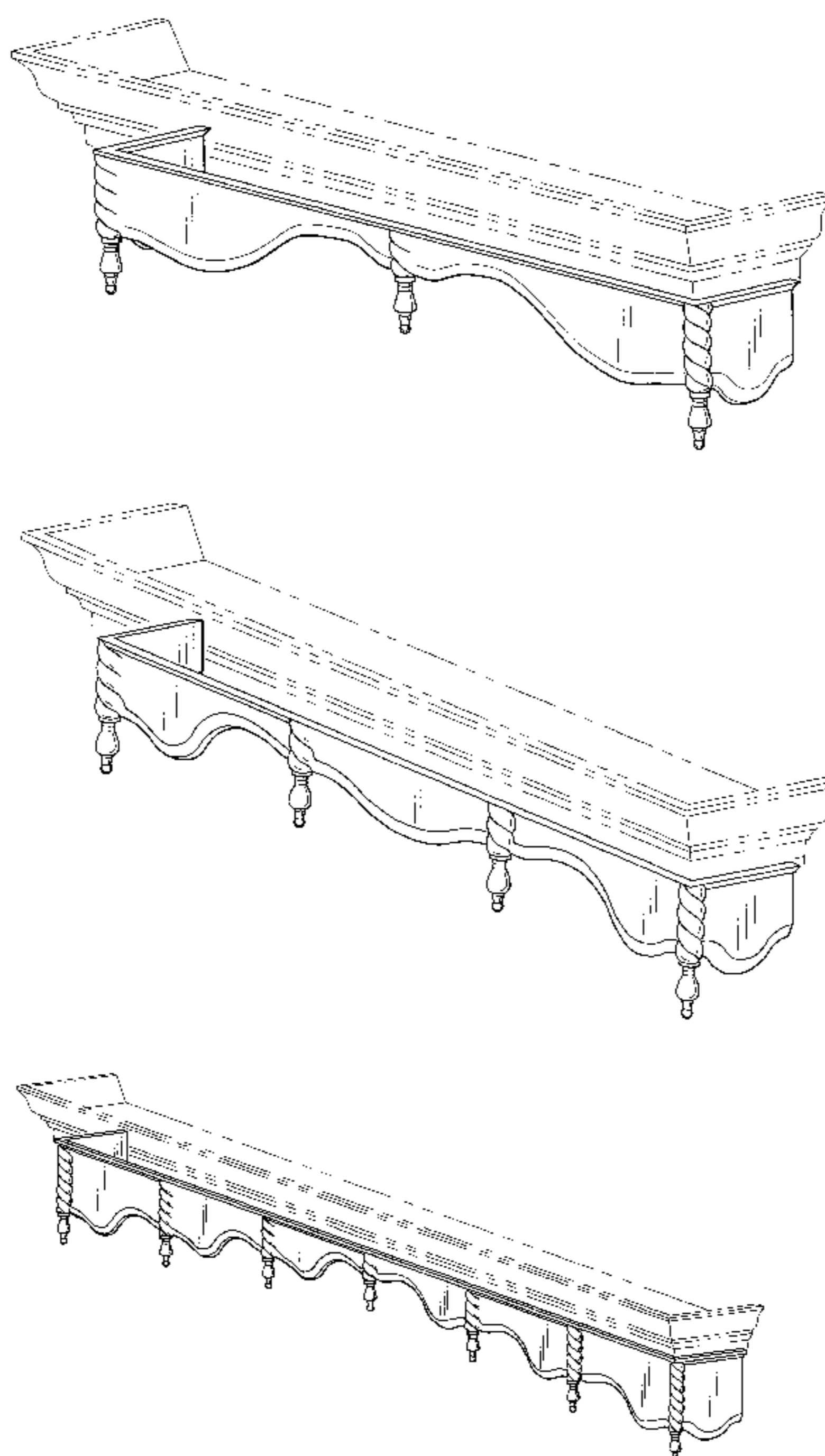

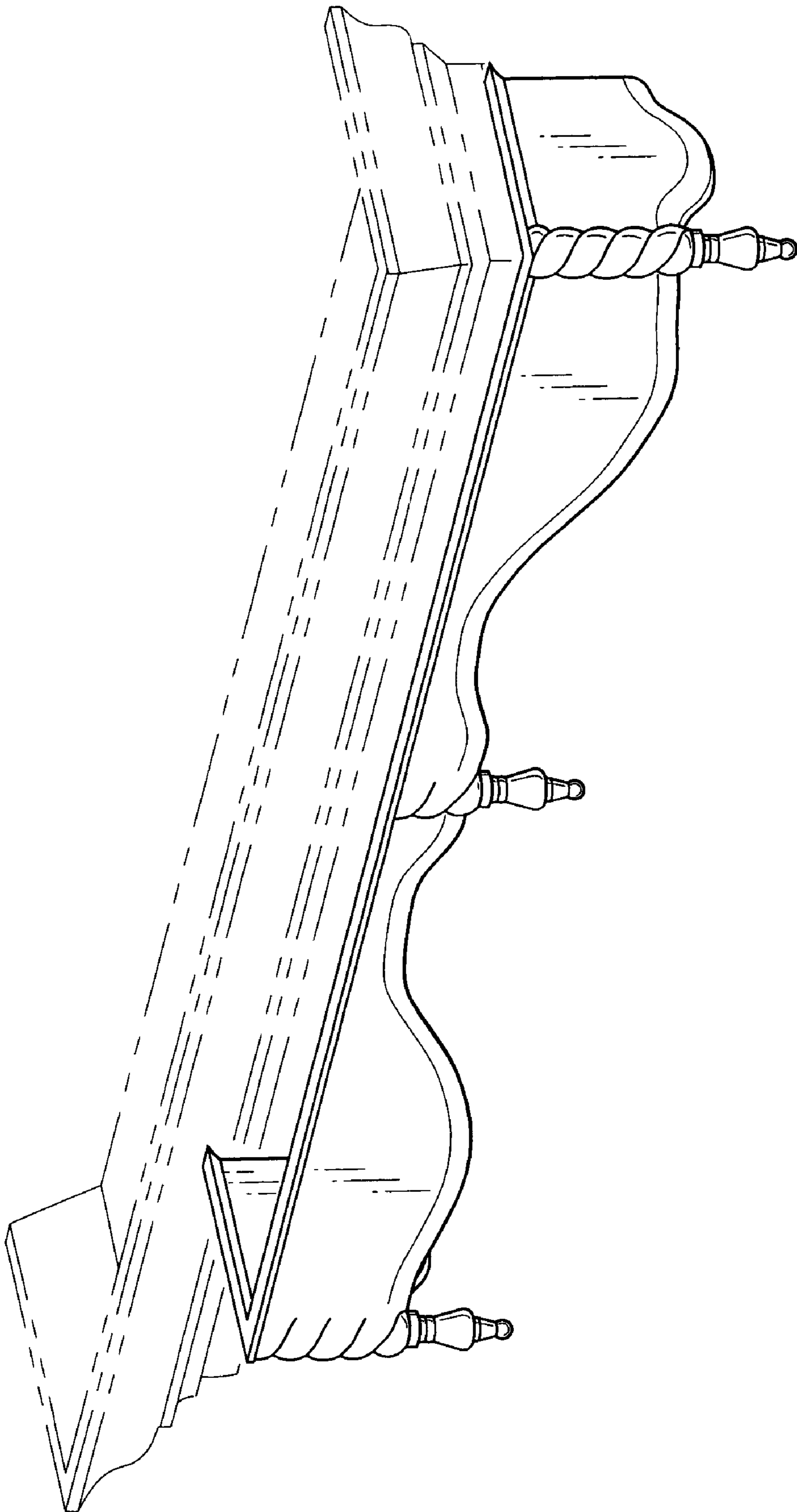

Fig. 1

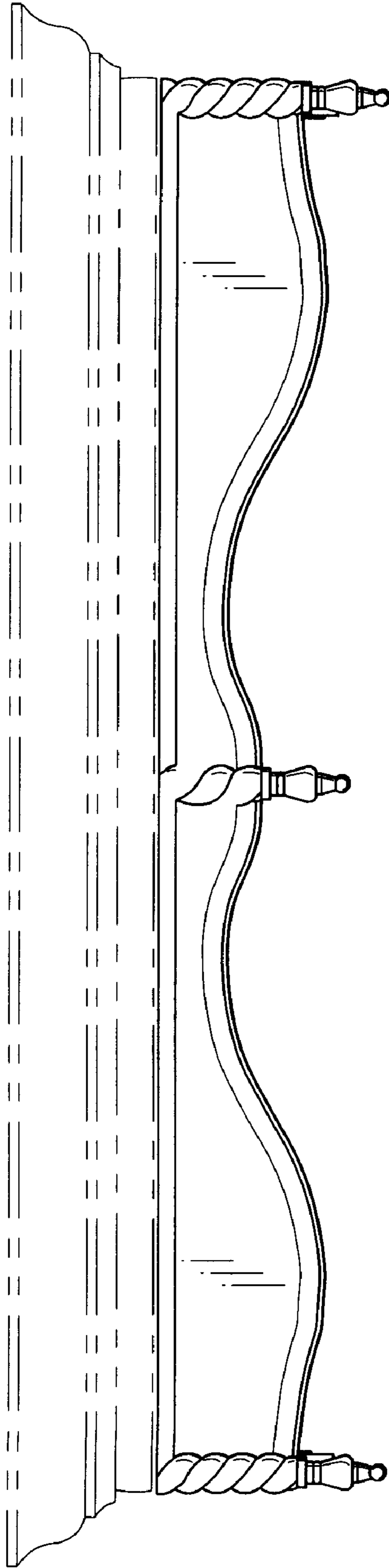

Fig. 2

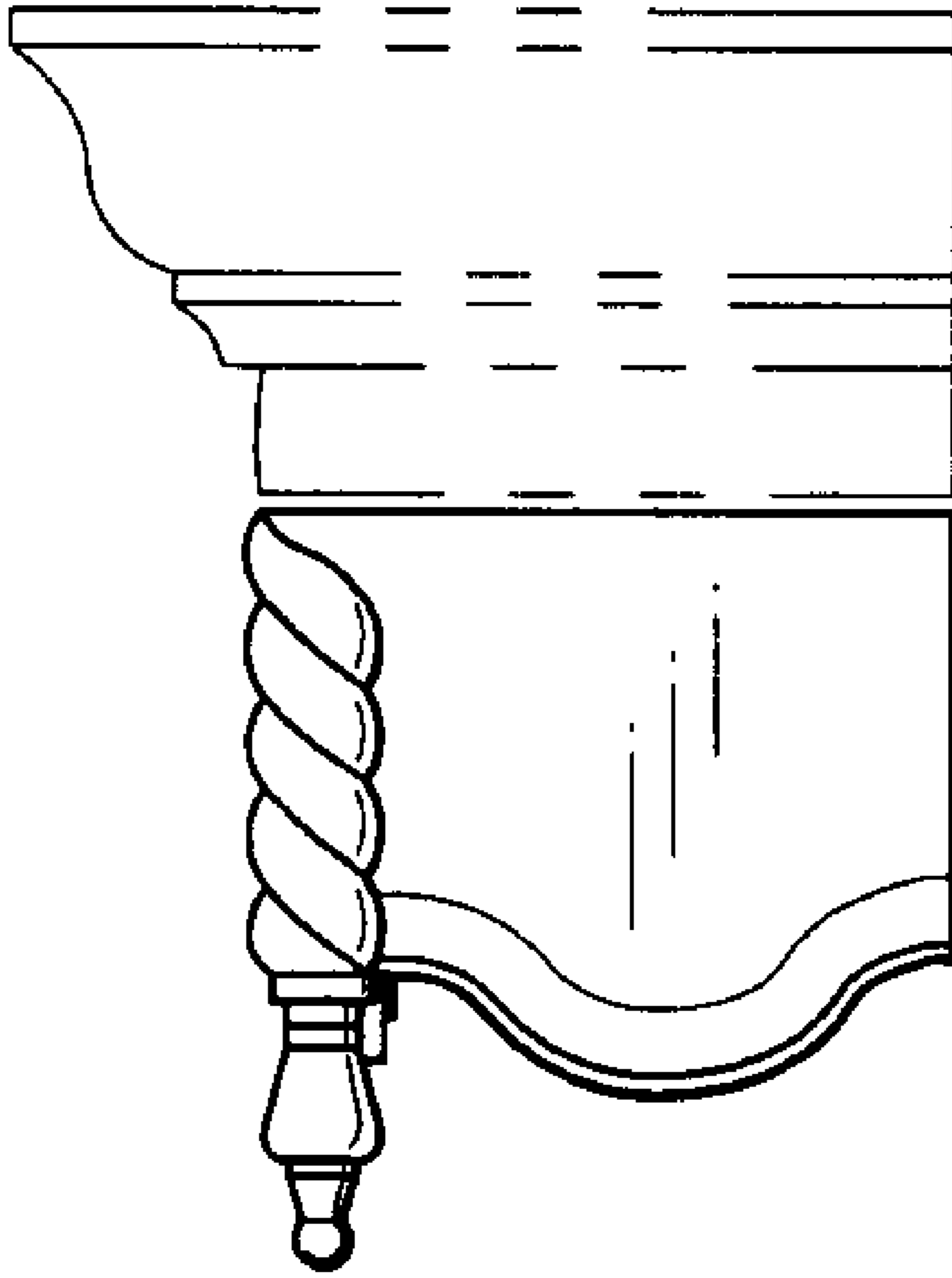

Fig. 3

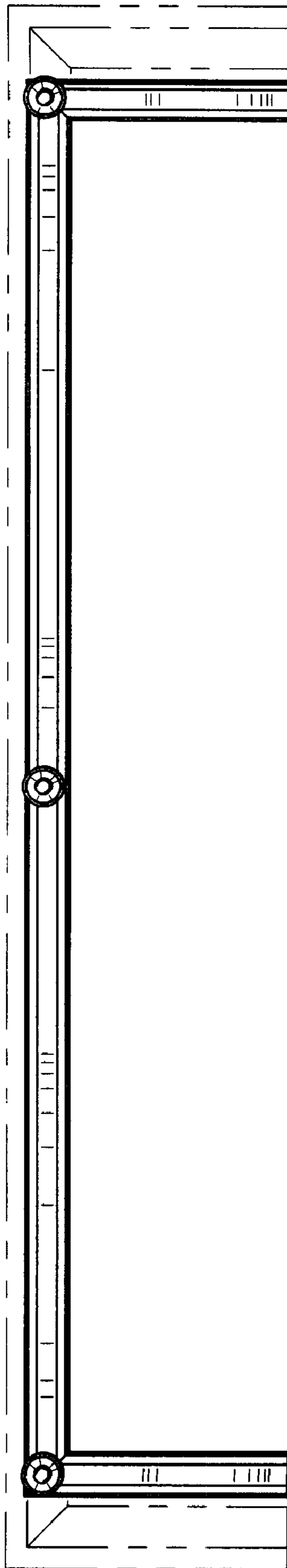

Fig. 4

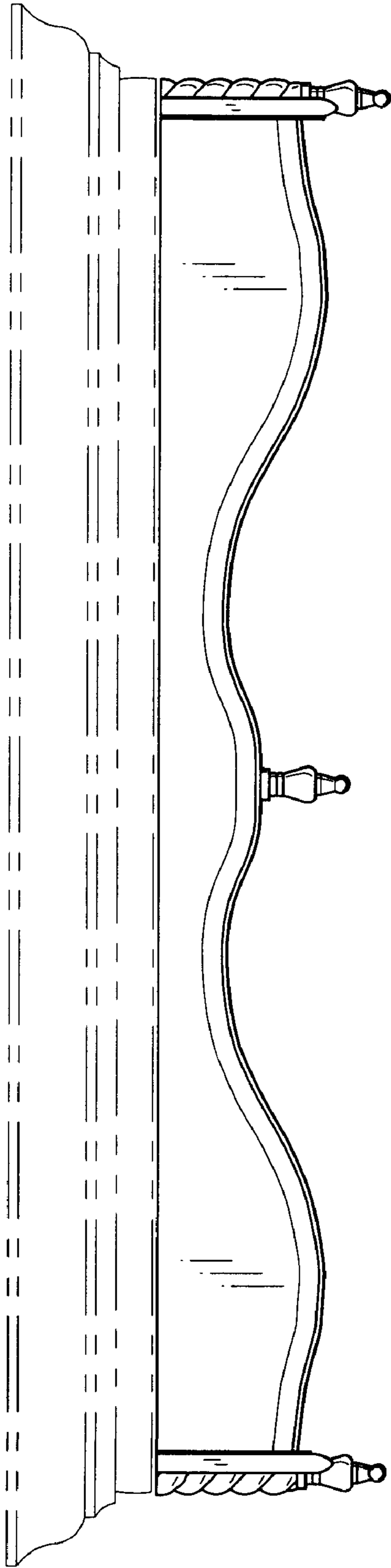

Fig. 5

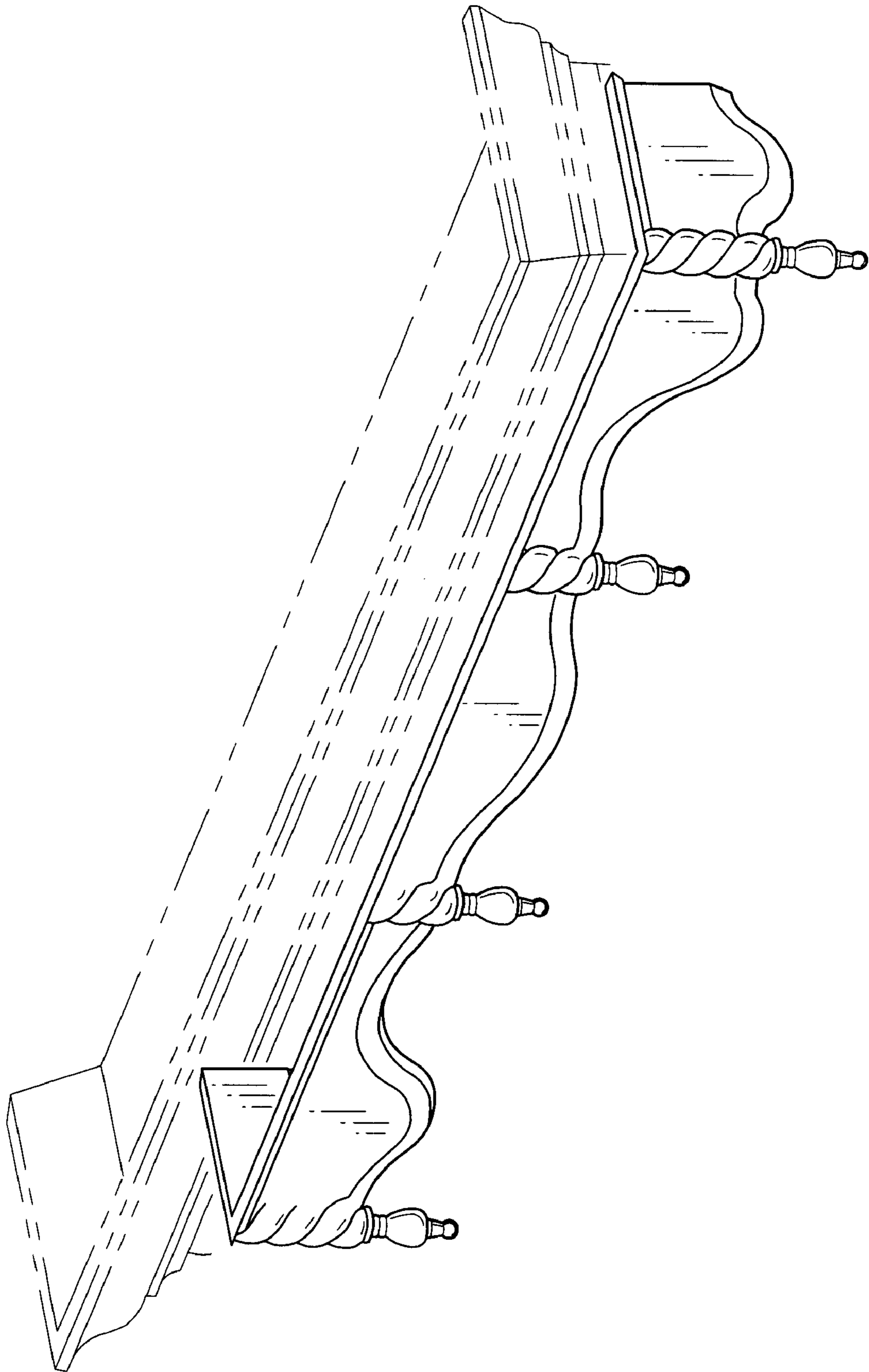

Fig. 6

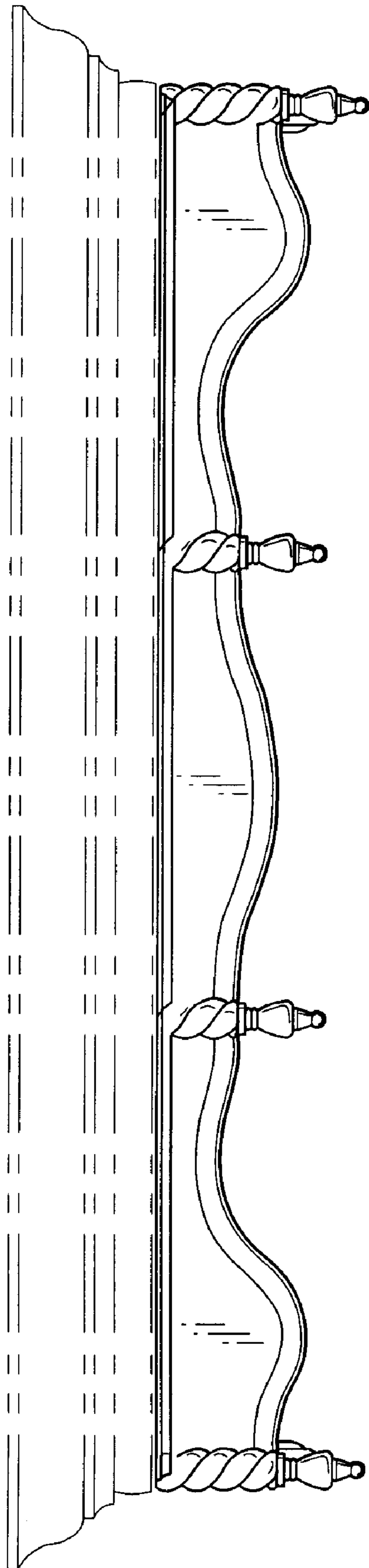

Fig. 7

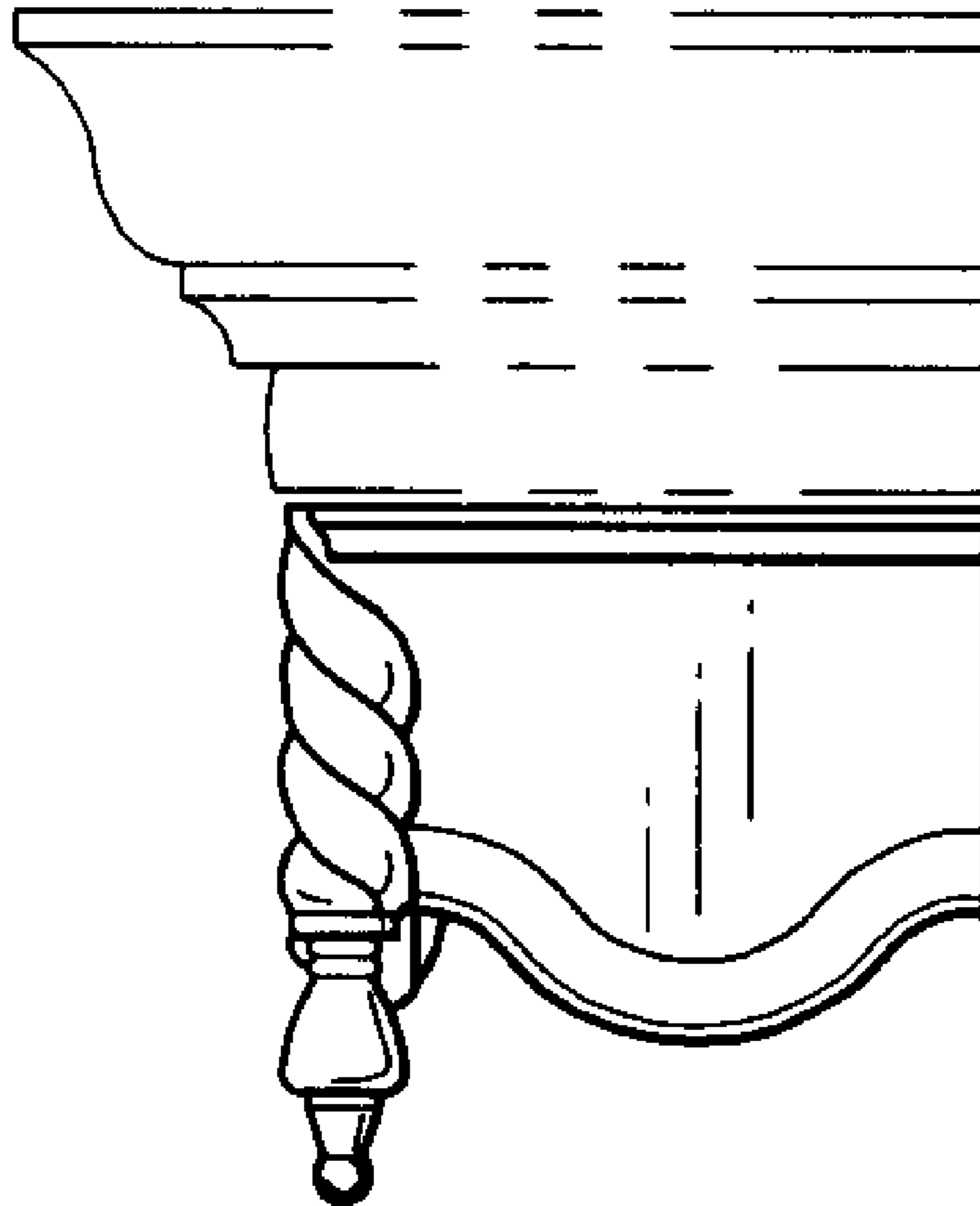

Fig. 8

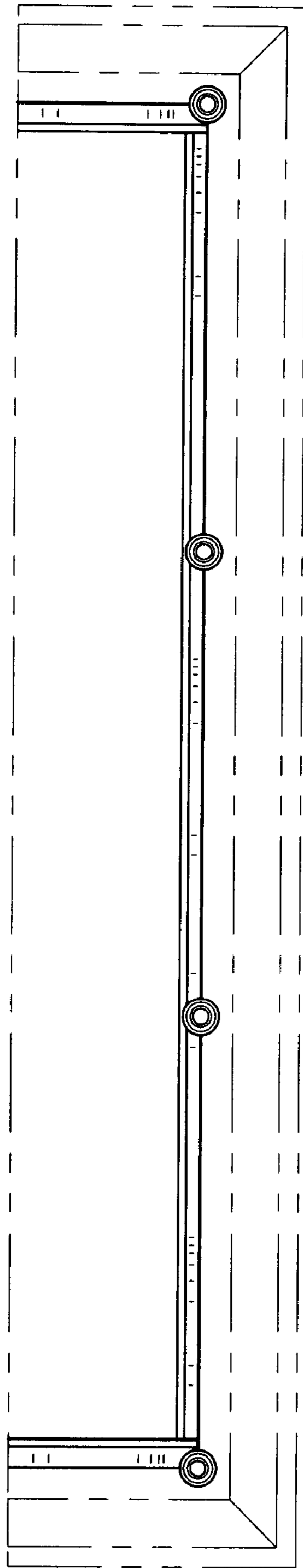

Fig. 9

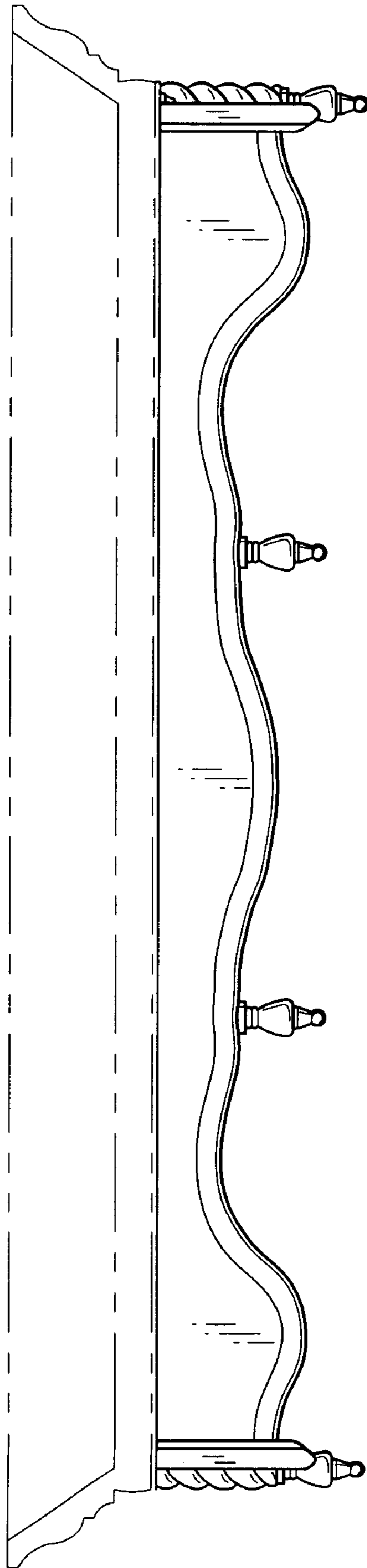

Fig. 10

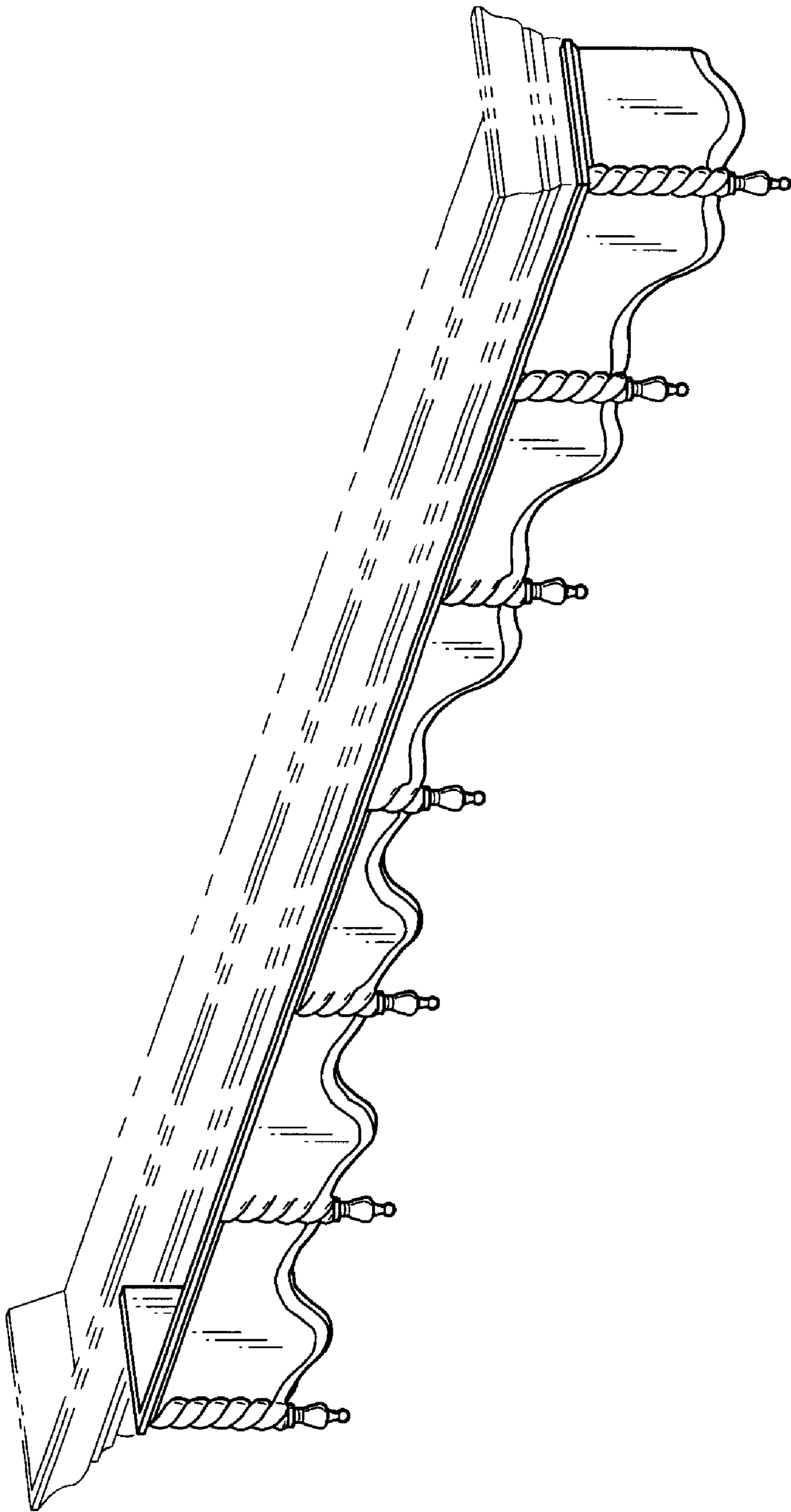

Fig. 11

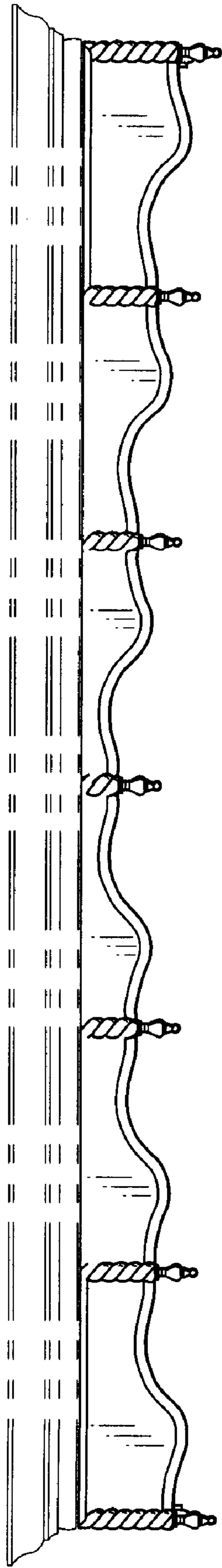

Fig. 12

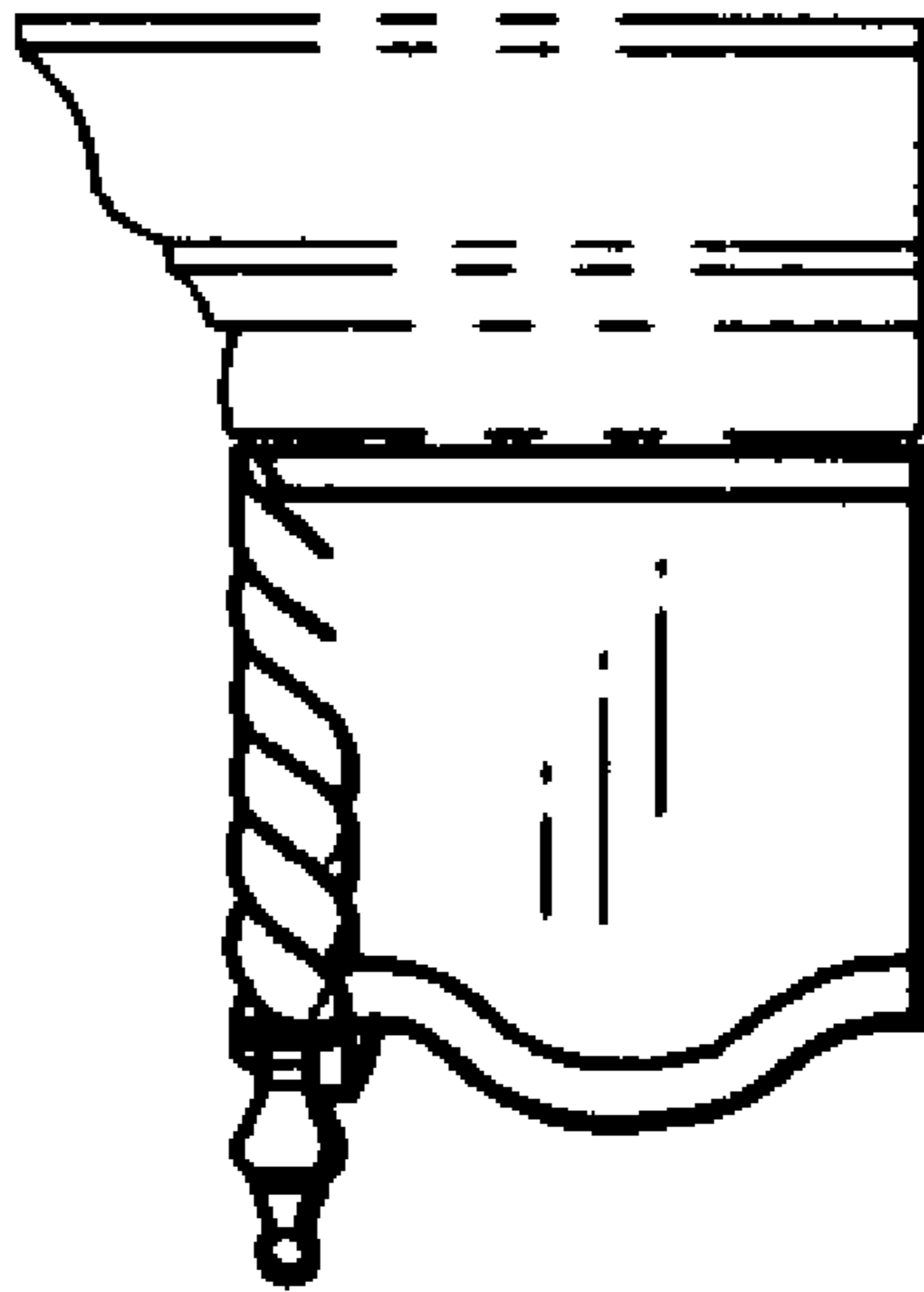

Fig. 13

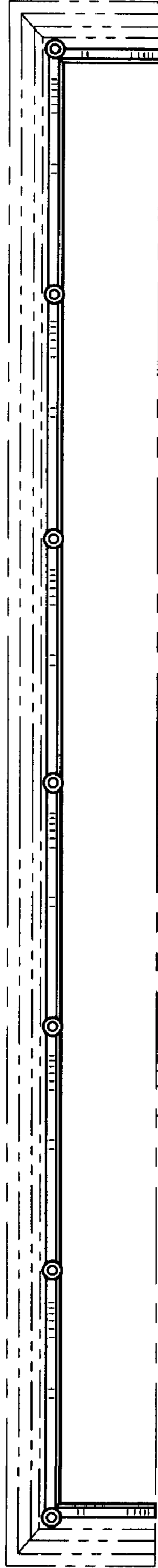

Fig. 14

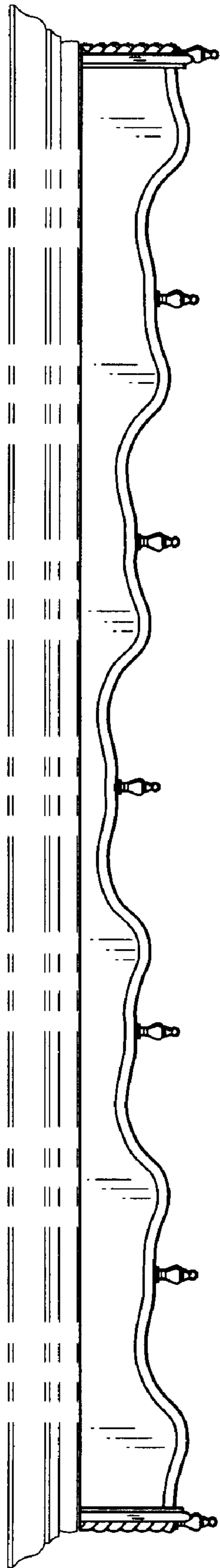

Fig. 15