



US00D486011S

(12) **United States Design Patent**  
**Scola**

(10) **Patent No.:** **US D486,011 S**

(45) **Date of Patent:** **\*\* Feb. 3, 2004**

(54) **PILL BOTTLE ORGANIZER**

D394,173 S \* 5/1998 Habib ..... D6/474

(76) Inventor: **Vito A. Scola**, 137 Apple Gate Rd.,  
Cranston, RI (US) 02920

\* cited by examiner

(\*\*) Term: **14 Years**

*Primary Examiner*—Cathron C. Brooks  
(74) *Attorney, Agent, or Firm*—Salter & Michaelson

(21) Appl. No.: **29/181,806**

(57) **CLAIM**

(22) Filed: **May 15, 2003**

The ornamental design for a pill bottle organizer, as shown.

**Related U.S. Application Data**

**DESCRIPTION**

(63) Continuation-in-part of application No. 29/174,093, filed on  
Jan. 10, 2003.

FIG. 1 is a perspective view of a pill bottle organizer  
showing my new design;

(51) **LOC (7) Cl.** ..... **06-04**

FIG. 2 is a top plan view thereof;

(52) **U.S. Cl.** ..... **D6/468; D6/474**

FIG. 3 is a bottom plan view thereof;

(58) **Field of Search** ..... D6/408, 467, 468,  
D6/469, 473, 474, 475, 476, 477-479, 511;  
108/59, 91, 93, 106, 147.12, 147.13; 211/85.4,  
49.1, 74, 183, 187, 188, 203; 206/562-564;  
220/513-516

FIG. 4 is a left side view thereof;

FIG. 5 is a right side view thereof;

FIG. 6 is a rear edge view thereof;

FIG. 7 is a front edge view thereof;

FIG. 8 is a perspective view of a modified form of my  
invention;

FIG. 9 is a top plan view thereof;

(56) **References Cited**

FIG. 10 is a bottom plan view thereof;

**U.S. PATENT DOCUMENTS**

FIG. 11 is a left side view thereof;

1,848,214 A \* 3/1932 Brown ..... 211/128.1

FIG. 12 is a right side view thereof;

D165,565 S \* 12/1951 White ..... D28/86

FIG. 13 is a rear end view thereof; and,

D260,208 S \* 8/1981 Nutting ..... D6/468

FIG. 14 is a front end view thereof.

D349,204 S \* 8/1994 Lefebvre ..... D6/476

**1 Claim, 8 Drawing Sheets**

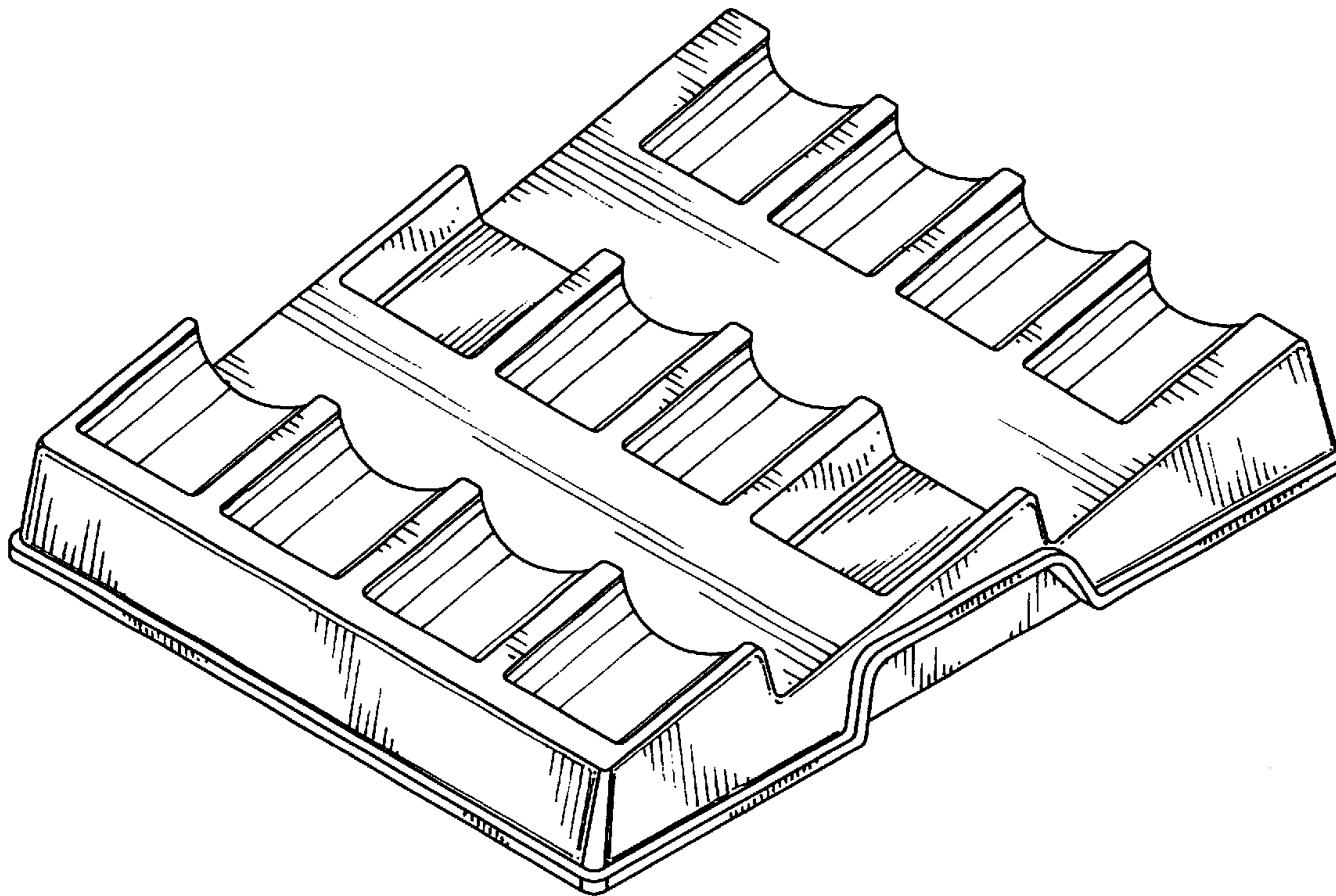

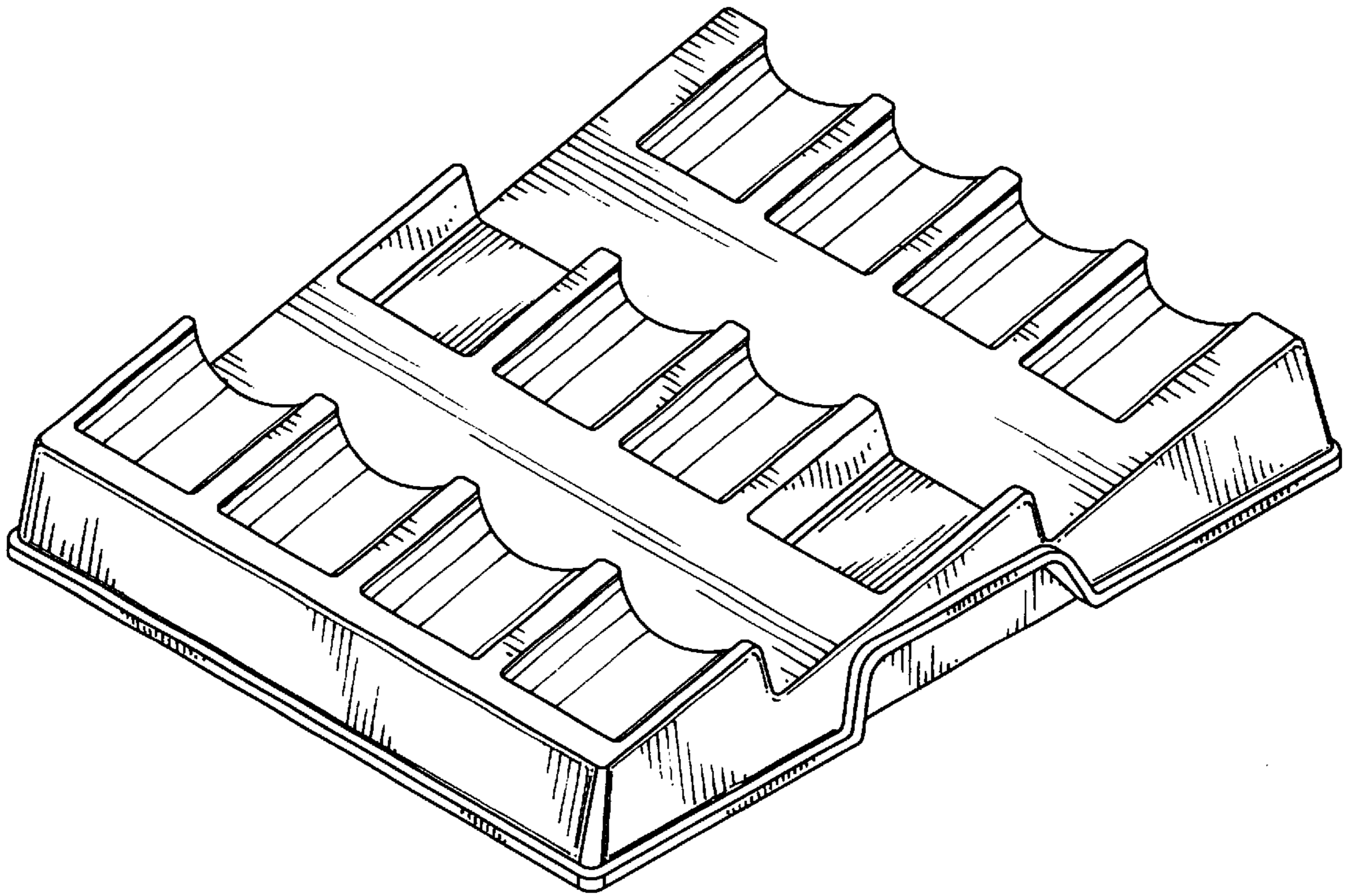

FIG. 1

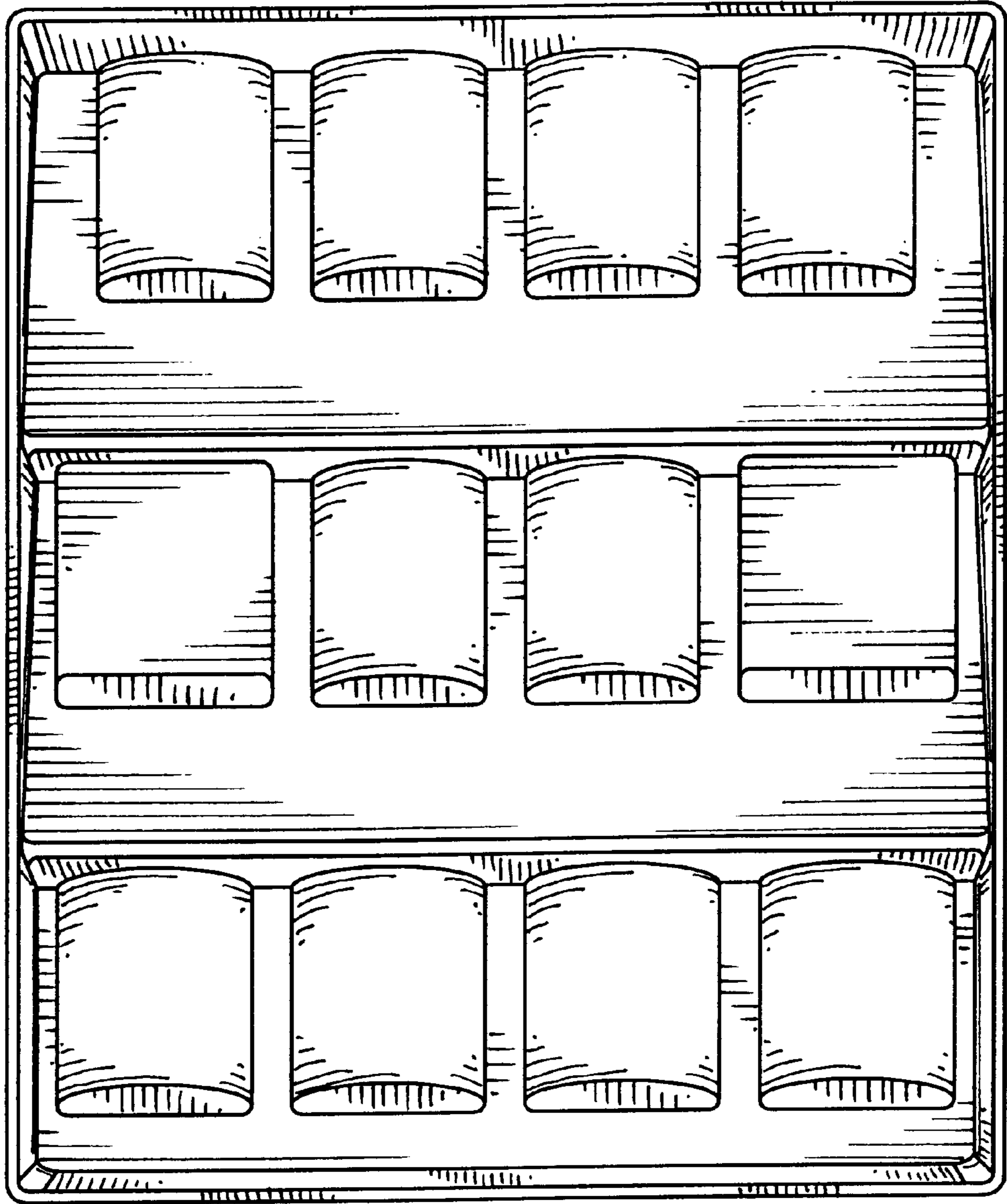

FIG. 2

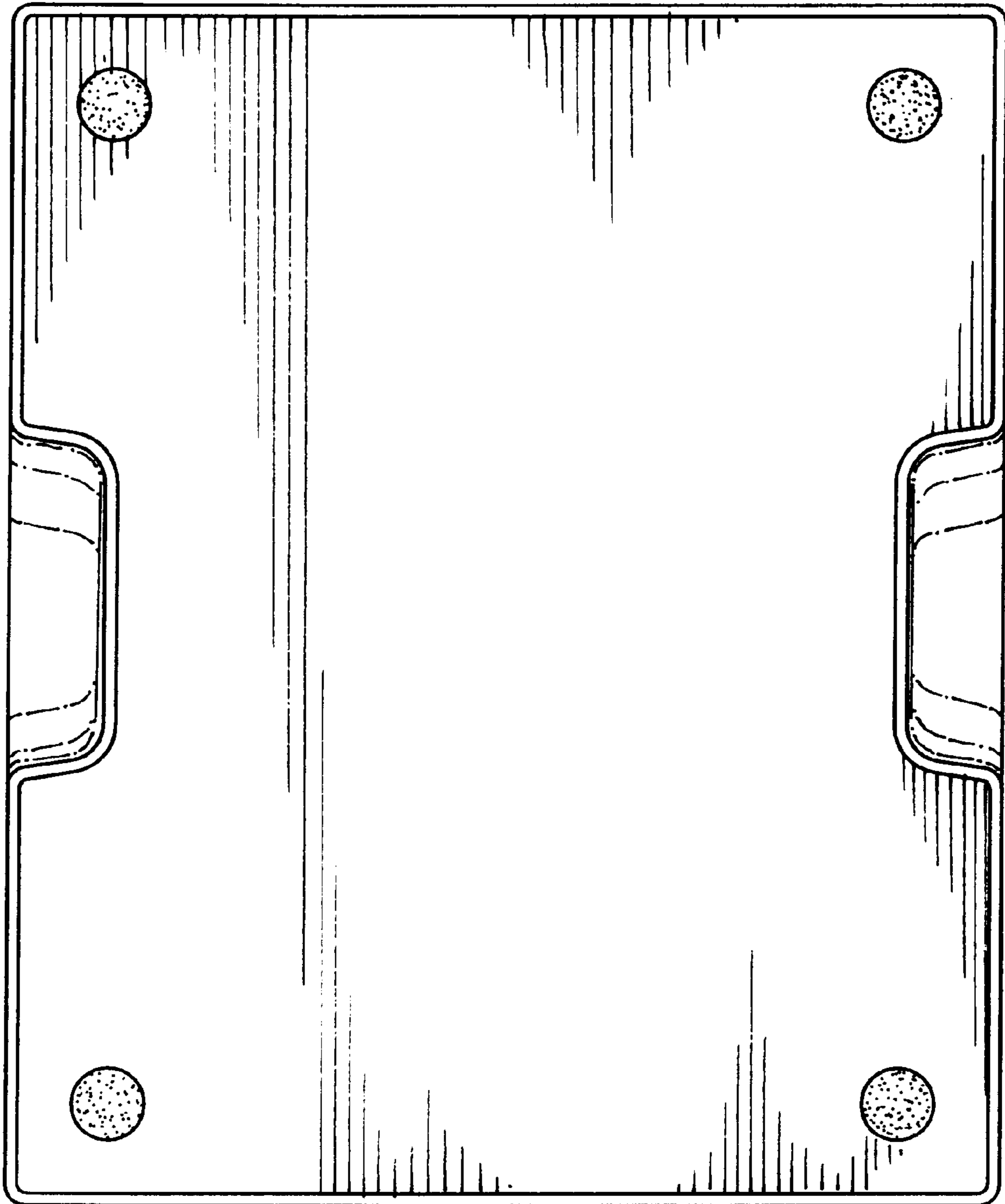

FIG. 3

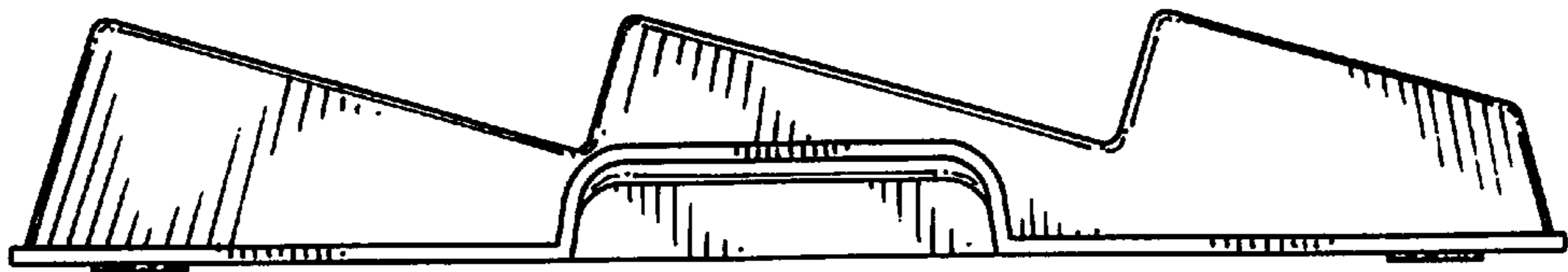

FIG. 4

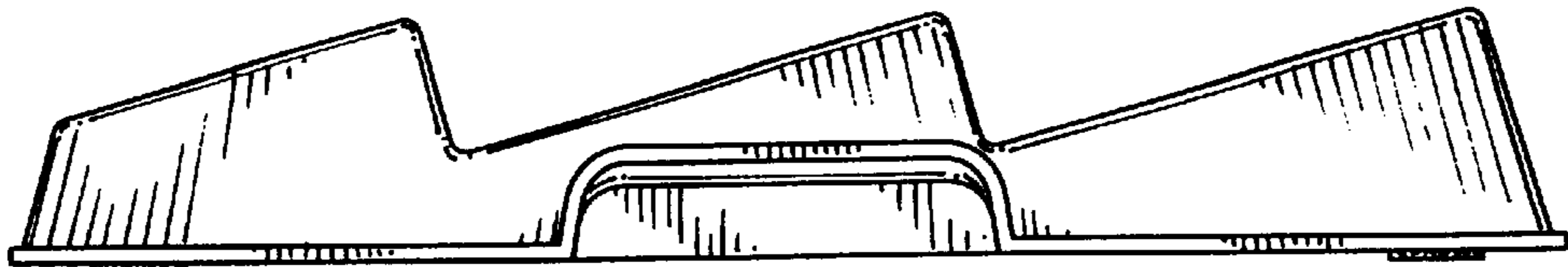

FIG. 5

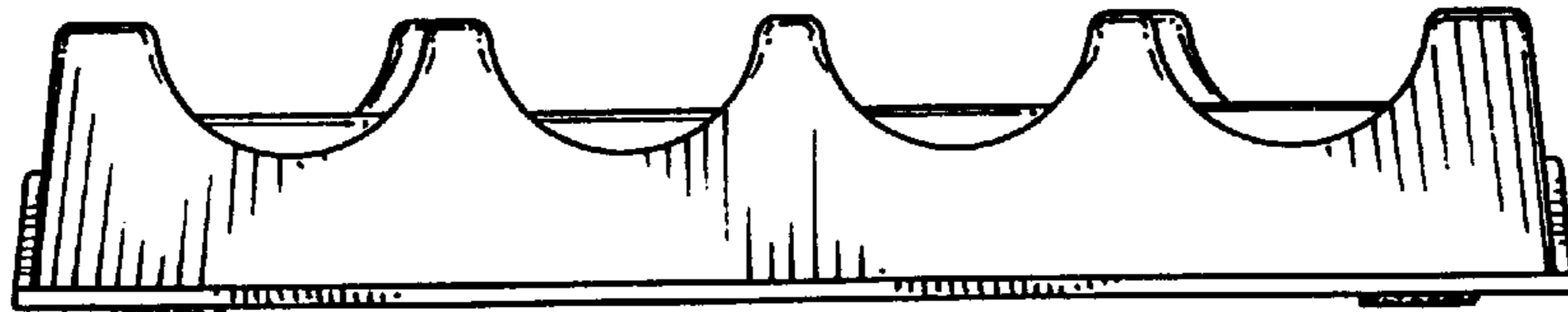

FIG. 6

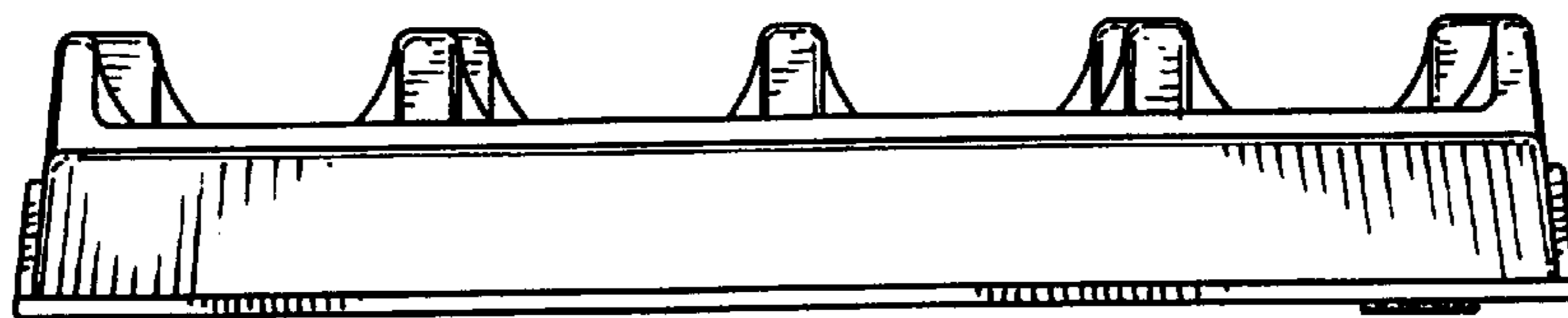

FIG. 7

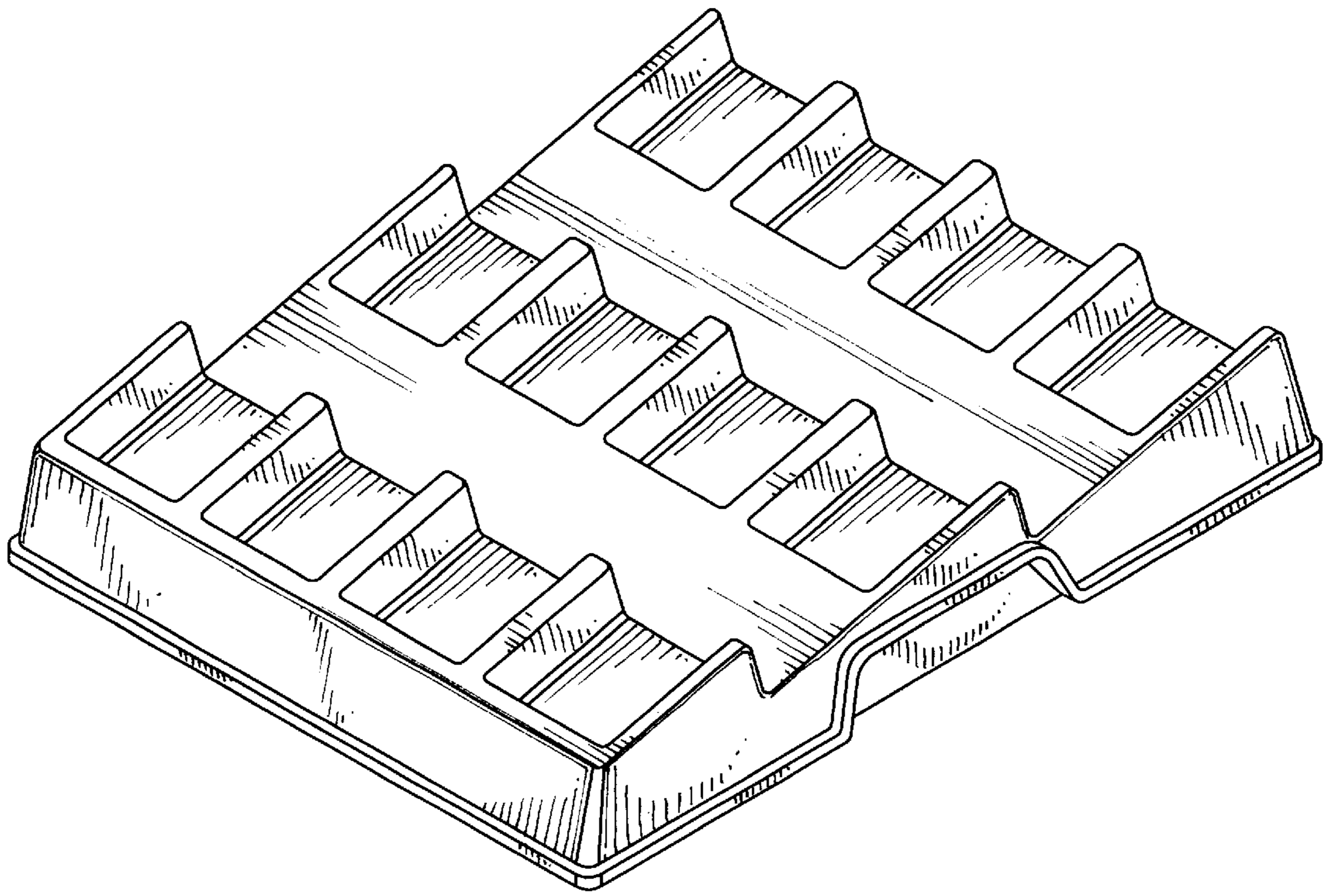

FIG. 8

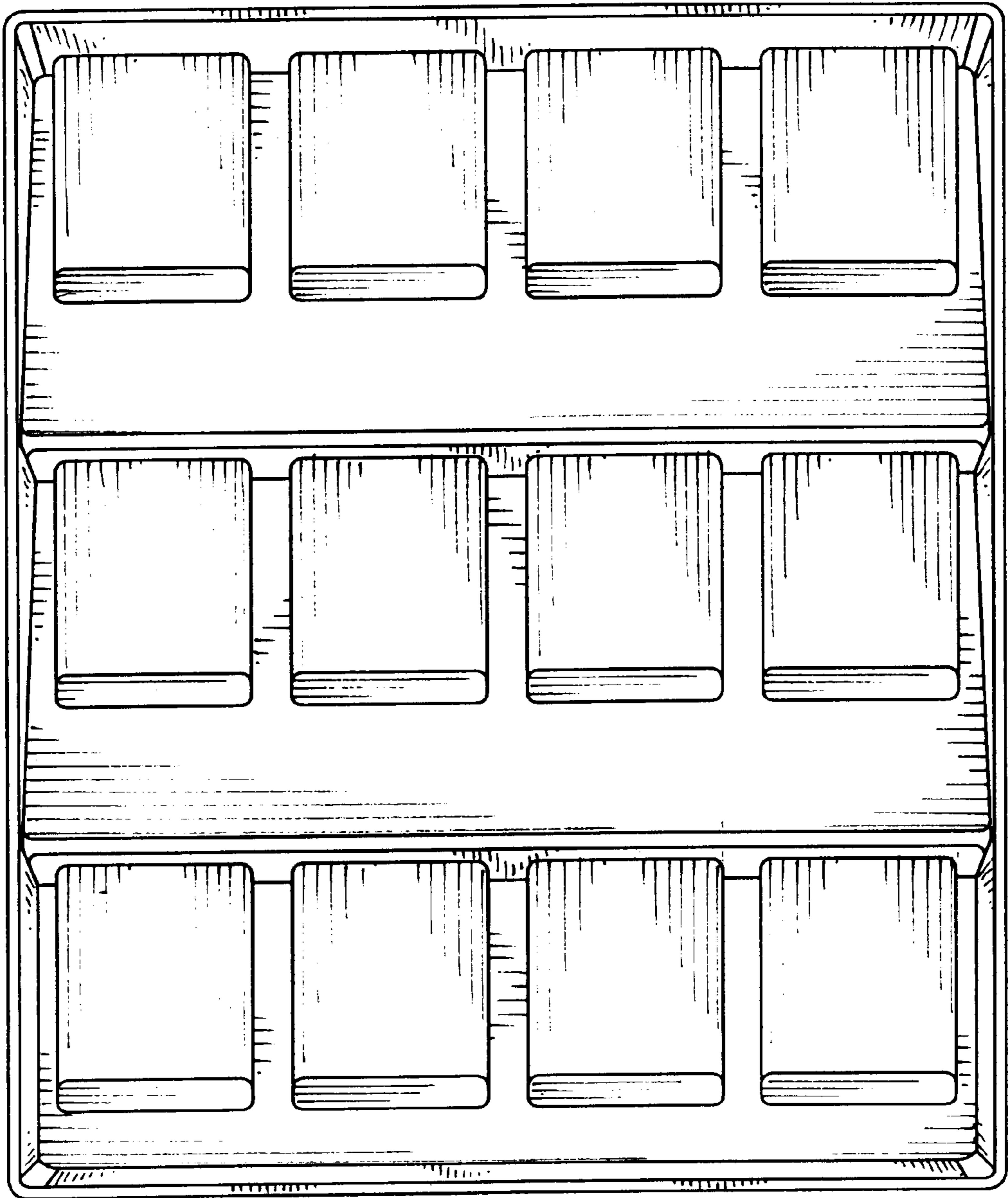

FIG. 9

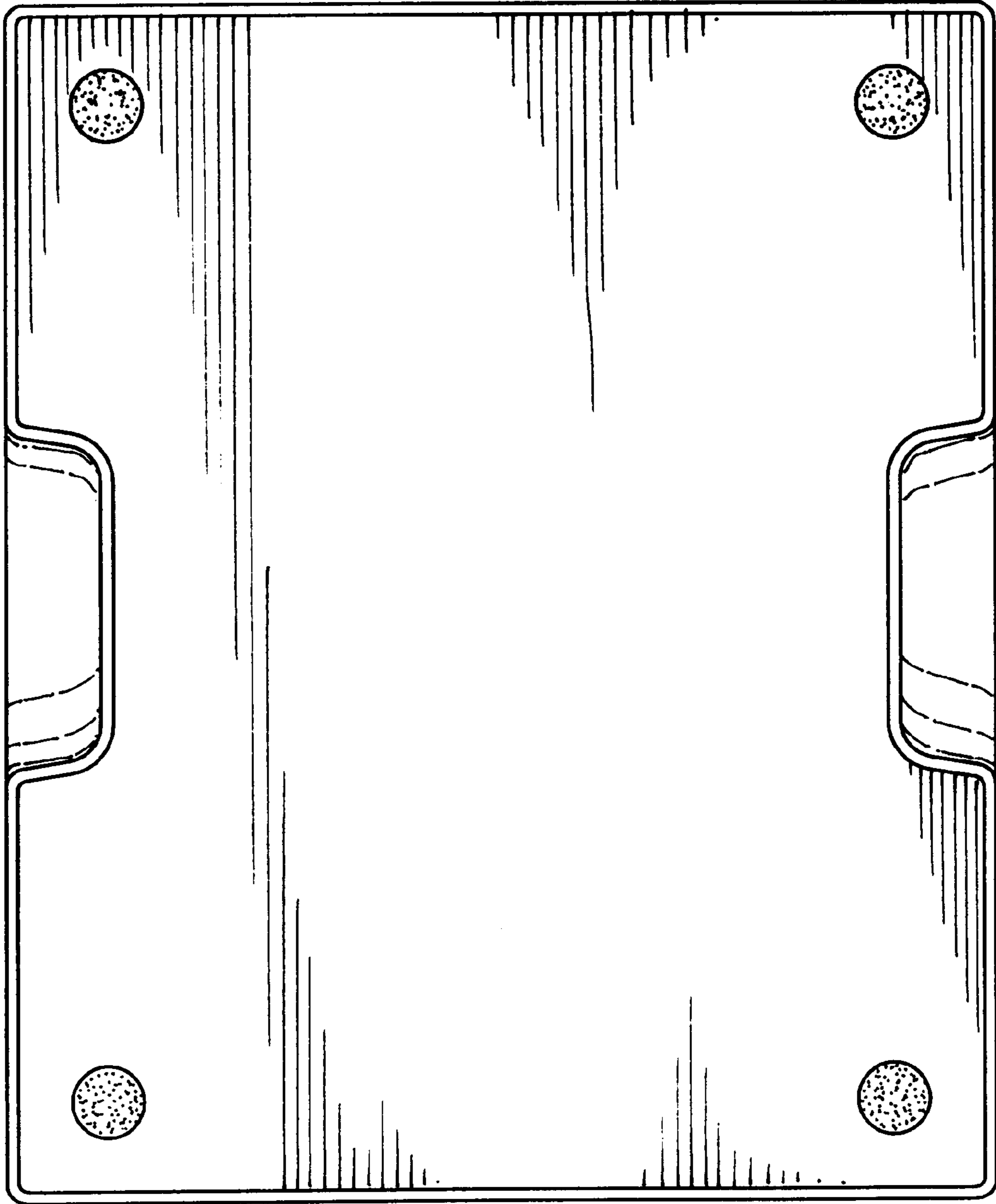

FIG. 10



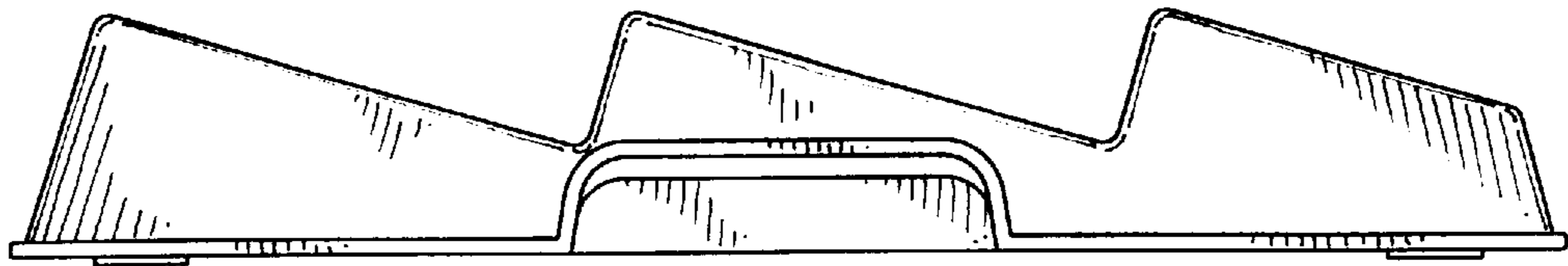

FIG. 11

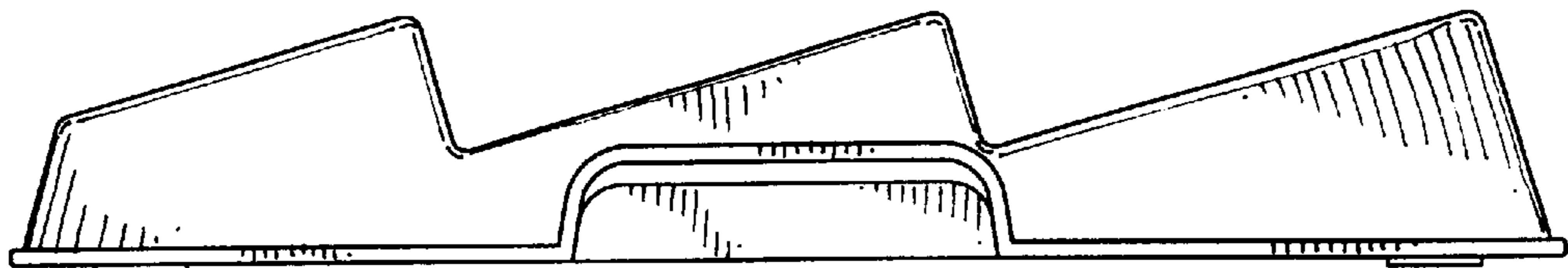

FIG. 12

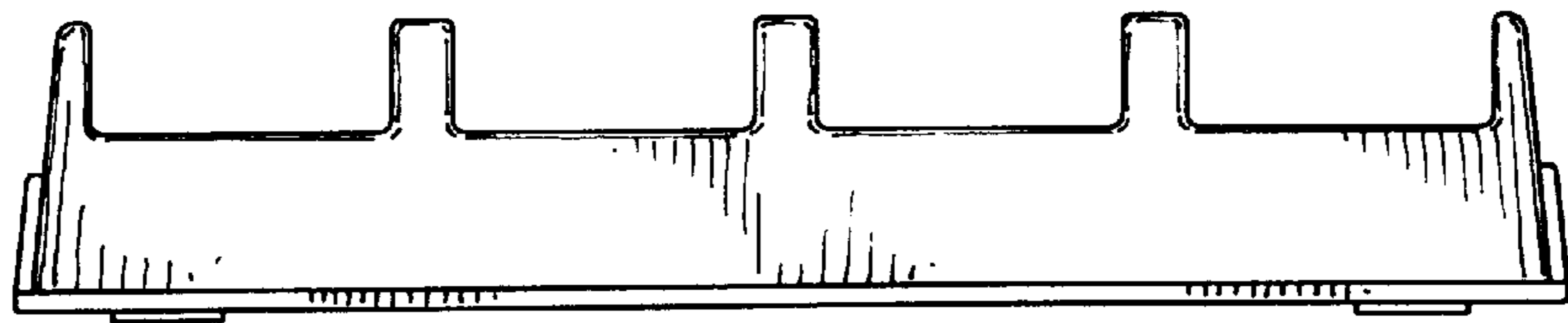

FIG. 13

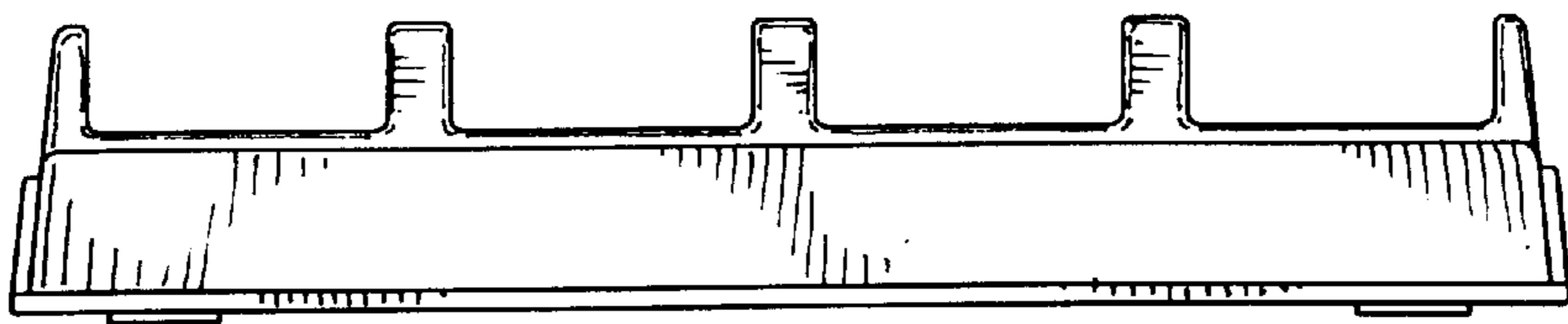

FIG. 14