



US00D485954S

(12) **United States Design Patent**
Hall et al.

(10) **Patent No.:** **US D485,954 S**
(45) **Date of Patent:** **** Jan. 27, 2004**

(54) **CLEANING FLUID RESERVOIR**

FOREIGN PATENT DOCUMENTS

(75) Inventors: **Michael J. Hall**, South San Francisco, CA (US); **James E. Rader**, Pleasanton, CA (US); **Karen S. Hefter**, San Ramon, CA (US); **Douglas Minkler**, Livermore, CA (US); **Robert W. Flagler**, Pleasanton, CA (US); **David J. Sayler**, Portland, OR (US); **Eric Y. Park**, Portland, OR (US)

WO WO 00/27746 5/2000

Primary Examiner—Philip S. Hyder
Assistant Examiner—C Tuttle
(74) *Attorney, Agent, or Firm*—Ray K. Shahani, Esq.; Joel J. Hayashida, Esq.; Mike Mazza, Esq.

(73) Assignee: **The Clorox Company**, Oakland, CA (US)

(57) **CLAIM**

We claim the ornamental design for a cleaning fluid reservoir, as shown and described.

(**) Term: **14 Years**

DESCRIPTION

(21) Appl. No.: **29/140,104**

This Application is related to and incorporates herein by reference, in its entirety, pending U.S. patent application Ser. No. 09/689,433 filed Oct. 11, 2000 now U.S. Pat. No. 6,540,424 entitled Advanced Cleaning System, and claims any and all benefits to which it is entitled therefrom, which is related to and incorporates by reference, in its entirety, U.S. Provisional patent application Ser. No. 60/192,040 filed Mar. 24, 2000 entitled Cleaning System, and claims any and all benefits to which it is entitled therefrom.

(22) Filed: **Apr. 11, 2001**

(51) **LOC (7) Cl.** **07-05**

(52) **U.S. Cl.** **D32/45; D32/30; D9/338; D9/520; D9/522**

(58) **Field of Search** D32/1, 15, 17, D32/25, 29, 30, 45; D9/337, 525, 338, 562, 516, 563, 520, 435, 522, 436, 530, 540, 447, 543, 449, 549, 450, 550, 452, 453, 571, 454, 575; D23/213, 223–225; 15/320, 321, 49.1, 302, 97.1, 98, 104.8, 246; 401/23, 24, 40–47, 137–140; 222/180, 181.1–181.3, 189.1, 173, 174, 183, 191, 204, 207, 211, 464.1, 464.3, 527–529, 533, 566; 215/3, 4, 227, 276, 277, 307, 310, 311, 902, 382–384

FIG. 1 is a front and side perspective view showing our new design for a cleaning fluid reservoir in an inverted position, along with broken lines showing unclaimed environment; FIG. 2 is another inverted perspective view showing the design in use;

FIG. 3 is an exploded bottom, front and left side perspective view showing the design on an enlarged scale;

FIG. 4 is a top, front and right side perspective view on an enlarged scale and with the cap and tube portions removed to disclose the underlying surfaces;

FIG. 5 is a top rear and left side perspective view thereof; and,

FIG. 6 is a front view with the cap element in place; and the tube shown fragmentarily for ease of illustration.

The broken lines showing cleaning system environmental structures are for illustrative purposes only and form no part of the claimed design.

(56) **References Cited**

U.S. PATENT DOCUMENTS

D92,532 S	*	6/1934	Graham	D9/563
D95,904 S	*	6/1935	Fuerst	D9/453
D102,368 S	*	12/1936	Higgins	D9/453
D178,876 S	*	10/1956	Glaberson	D9/563
2,783,919 A	*	3/1957	Ansell	222/211
D190,626 S	*	6/1961	Musichuk	D32/30

(List continued on next page.)

1 Claim, 5 Drawing Sheets

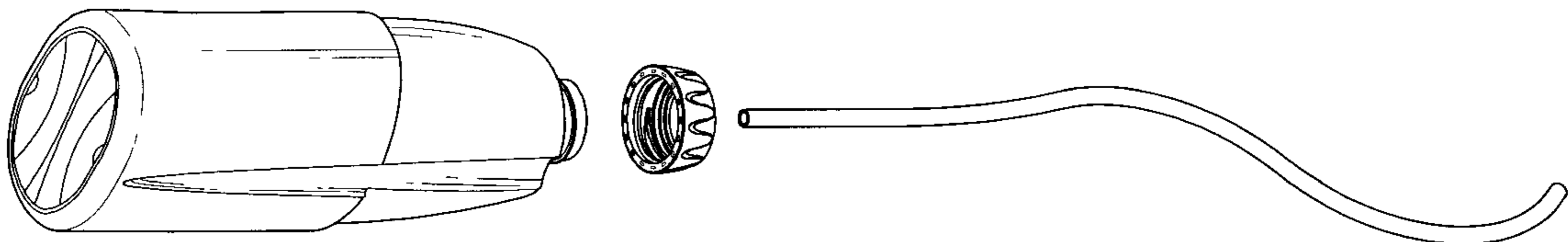

US D485,954 S

Page 2

U.S. PATENT DOCUMENTS

3,094,152 A	6/1963	Kenny et al.	
D200,364 S	* 2/1965	Brody	D9/447
D201,791 S	* 8/1965	Hershberger et al.	D32/30
D206,913 S	* 2/1967	Hills	D9/542
4,065,536 A	* 12/1977	Lucas	215/382 X
D257,504 S	* 11/1980	Weckman	D9/563
D354,683 S	* 1/1995	Rupert	D9/520
D394,607 S	* 5/1998	Monaghan et al.	D9/520
5,888,006 A	3/1999	Ping et al.	

* cited by examiner

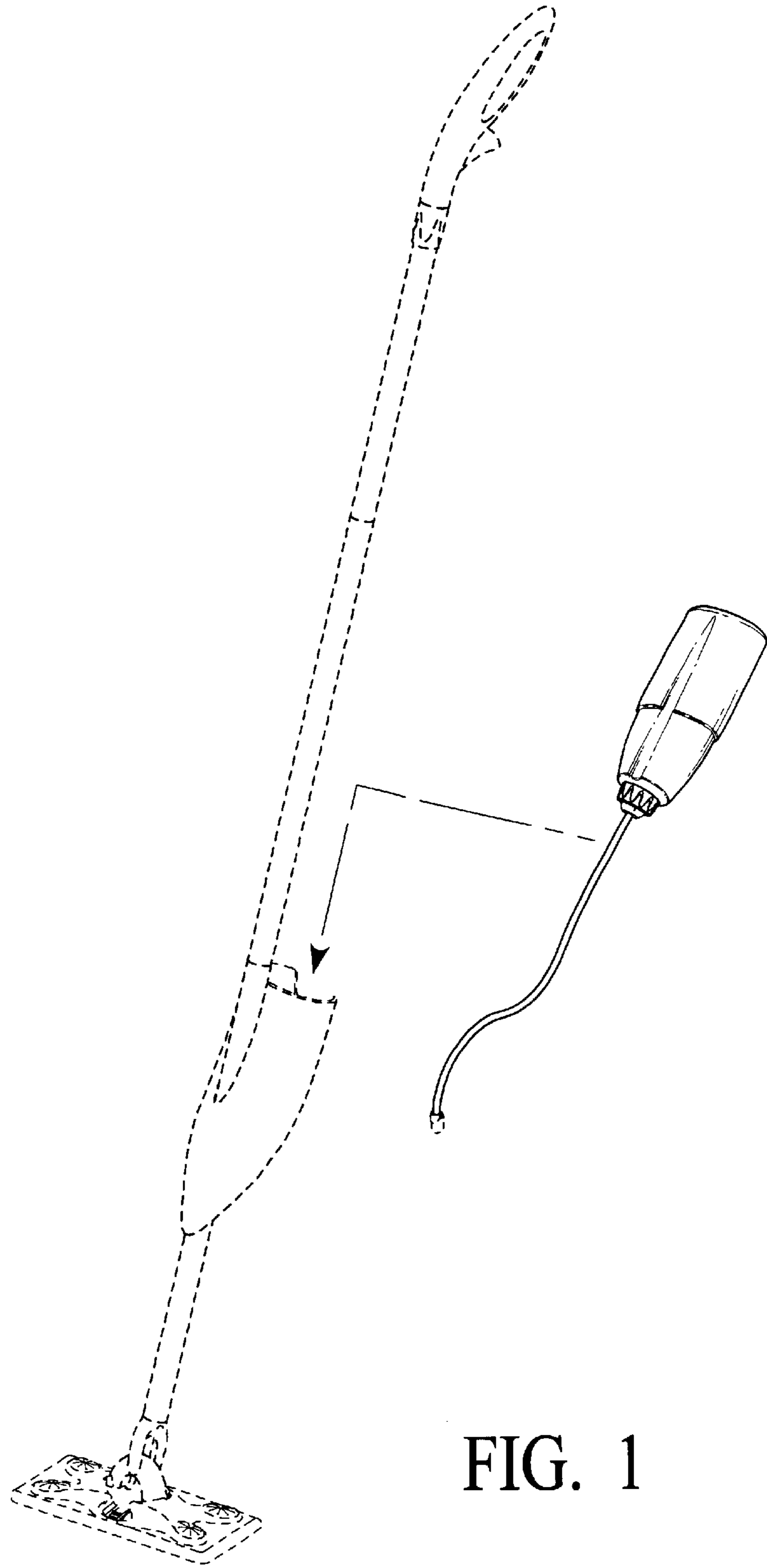

FIG. 1

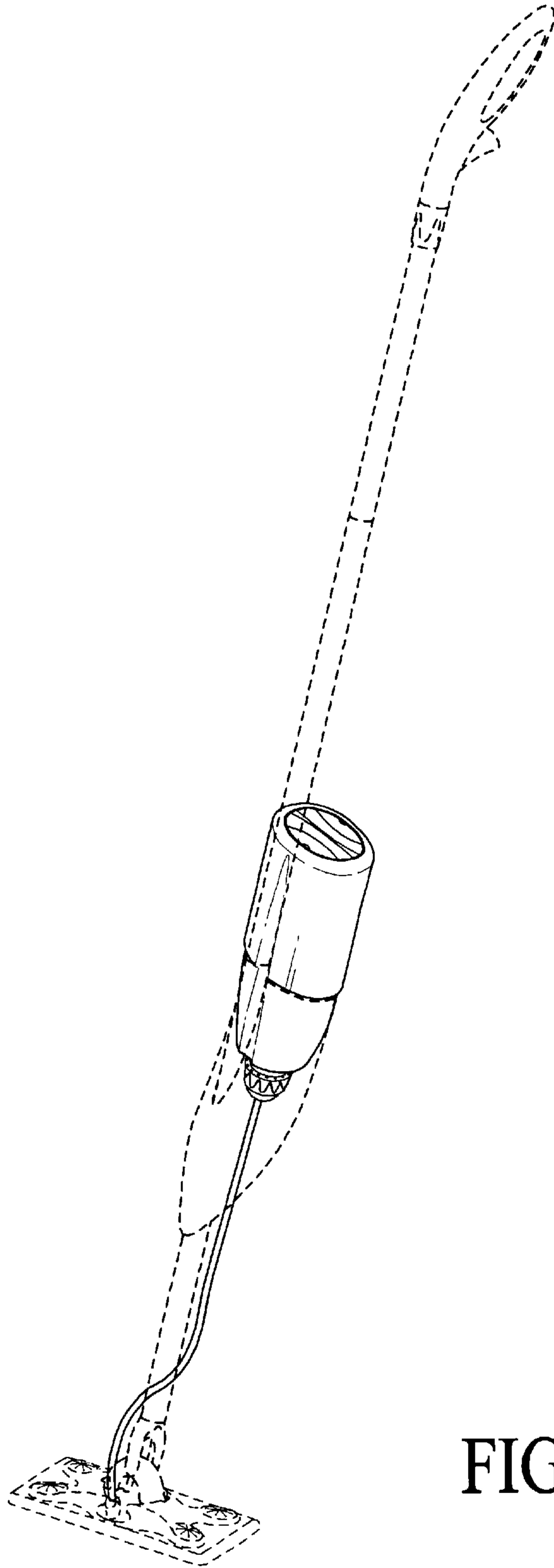

FIG. 2

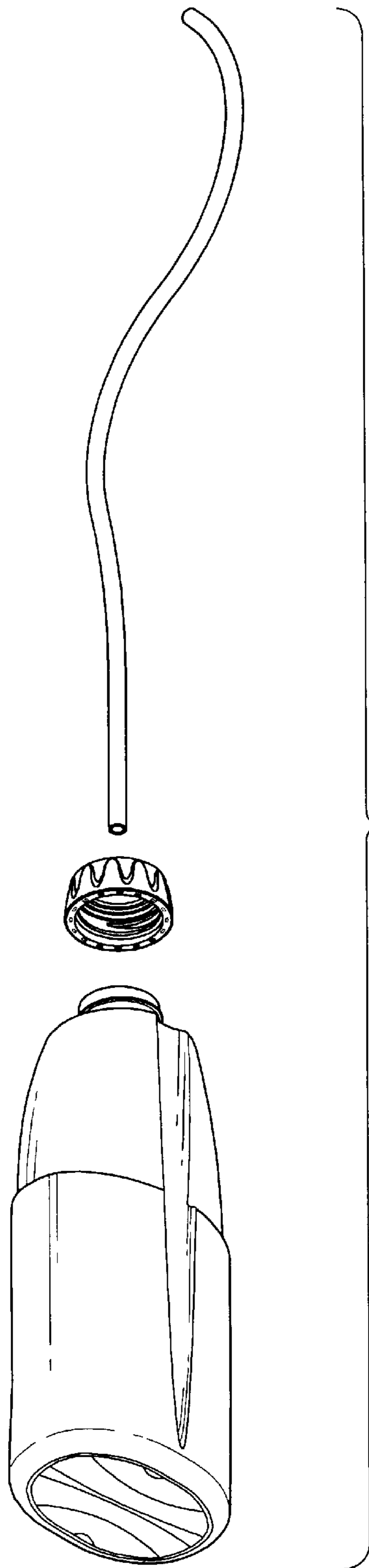

FIG. 3

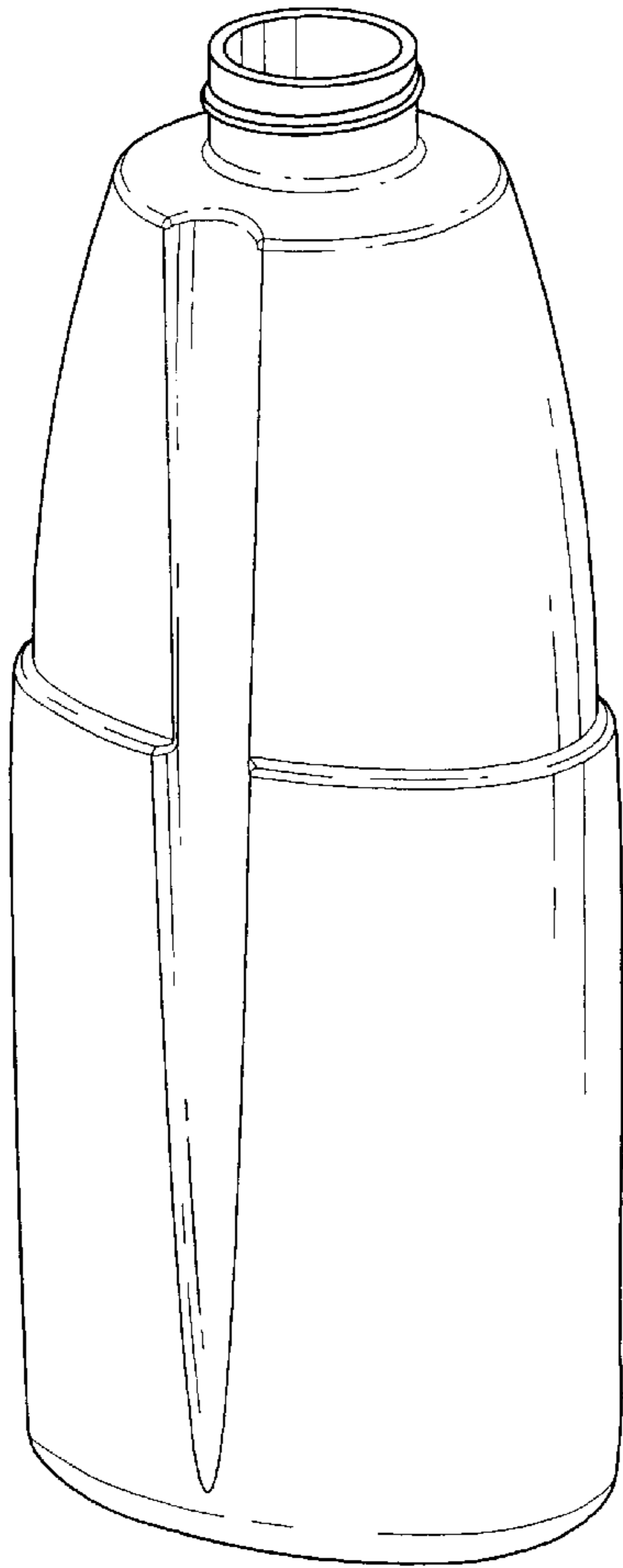

FIG. 4

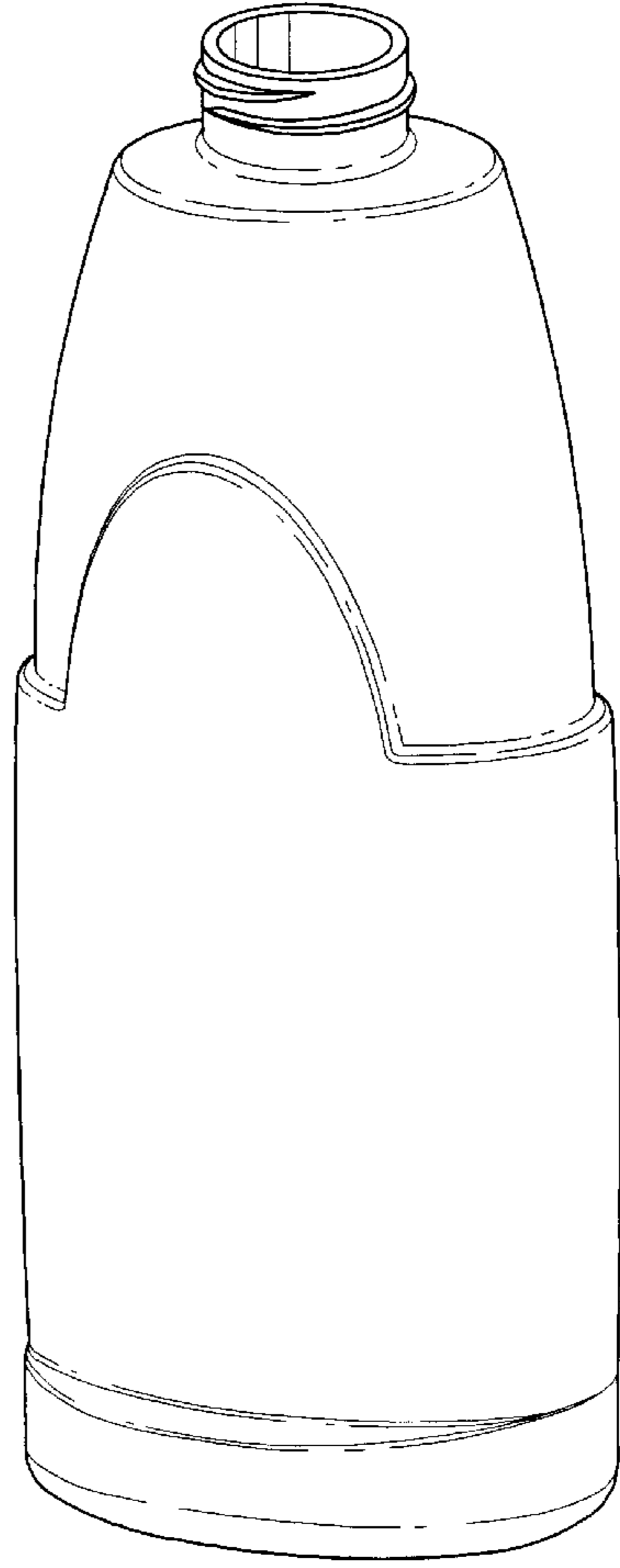

FIG. 5

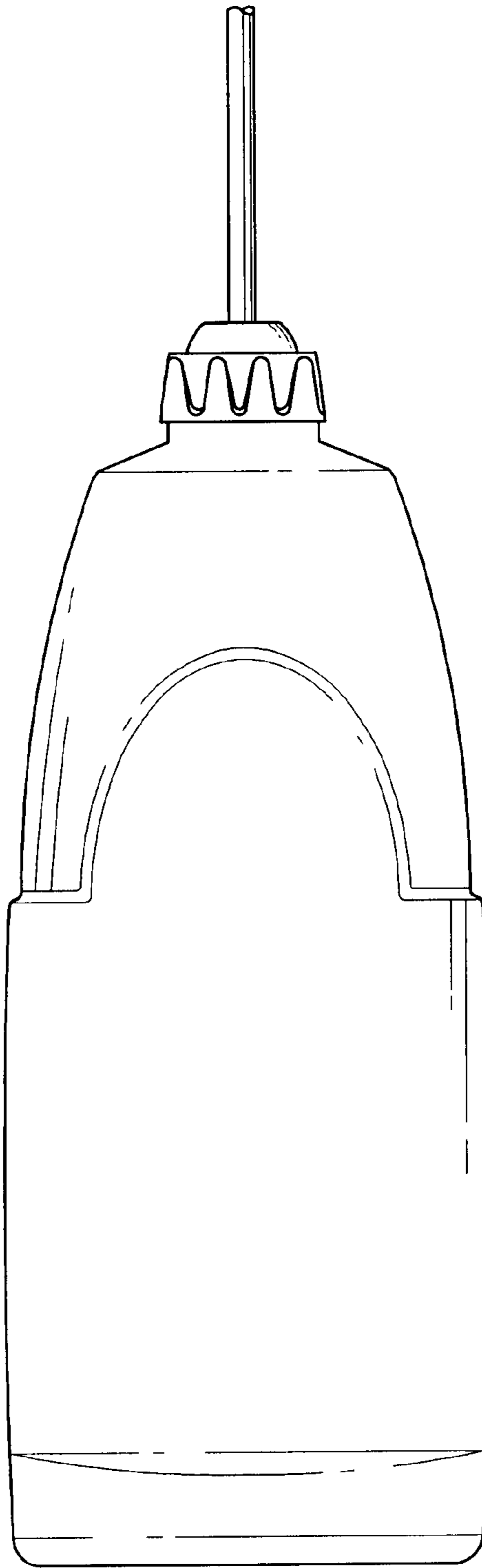

FIG. 6