



US00D485934S

(12) **United States Design Patent**
Tsai

(10) **Patent No.:** **US D485,934 S**

(45) **Date of Patent:** **** Jan. 27, 2004**

(54) **HEADLAMP RIM**

(76) **Inventor:** **Ping-Chung Tsai**, 11F, No. 328-10,
Chinhu Rd., Neihu Dist., Taipei (TW)

(**) **Term:** **14 Years**

(21) **Appl. No.:** **29/181,532**

(22) **Filed:** **May 13, 2003**

(51) **LOC (7) Cl.** **26-99**

(52) **U.S. Cl.** **D26/139**

(58) **Field of Search** D26/28-35, 139;
362/61, 70, 71, 72, 80, 82, 83, 329-340,
354, 359

(56) **References Cited**

U.S. PATENT DOCUMENTS

D387,471 S * 12/1997 Alger D26/139

D403,803 S * 1/1999 Alger D26/139

* cited by examiner

Primary Examiner—Marcus A. Jackson
(74) *Attorney, Agent, or Firm*—Alan D. Kamrath; Rider
Bennett, LLP

(57) **CLAIM**

The ornamental design for a headlamp rim, as shown.

DESCRIPTION

FIG. 1 is a perspective view of a headlamp rim, showing my
new design;

FIG. 2 is a front elevational view thereof;

FIG. 3 is a rear elevational view thereof;

FIG. 4 is a left elevational view thereof;

FIG. 5 is a right elevational view thereof;

FIG. 6 is a top plan view thereof; and,

FIG. 7 is a bottom plan view thereof.

1 Claim, 5 Drawing Sheets

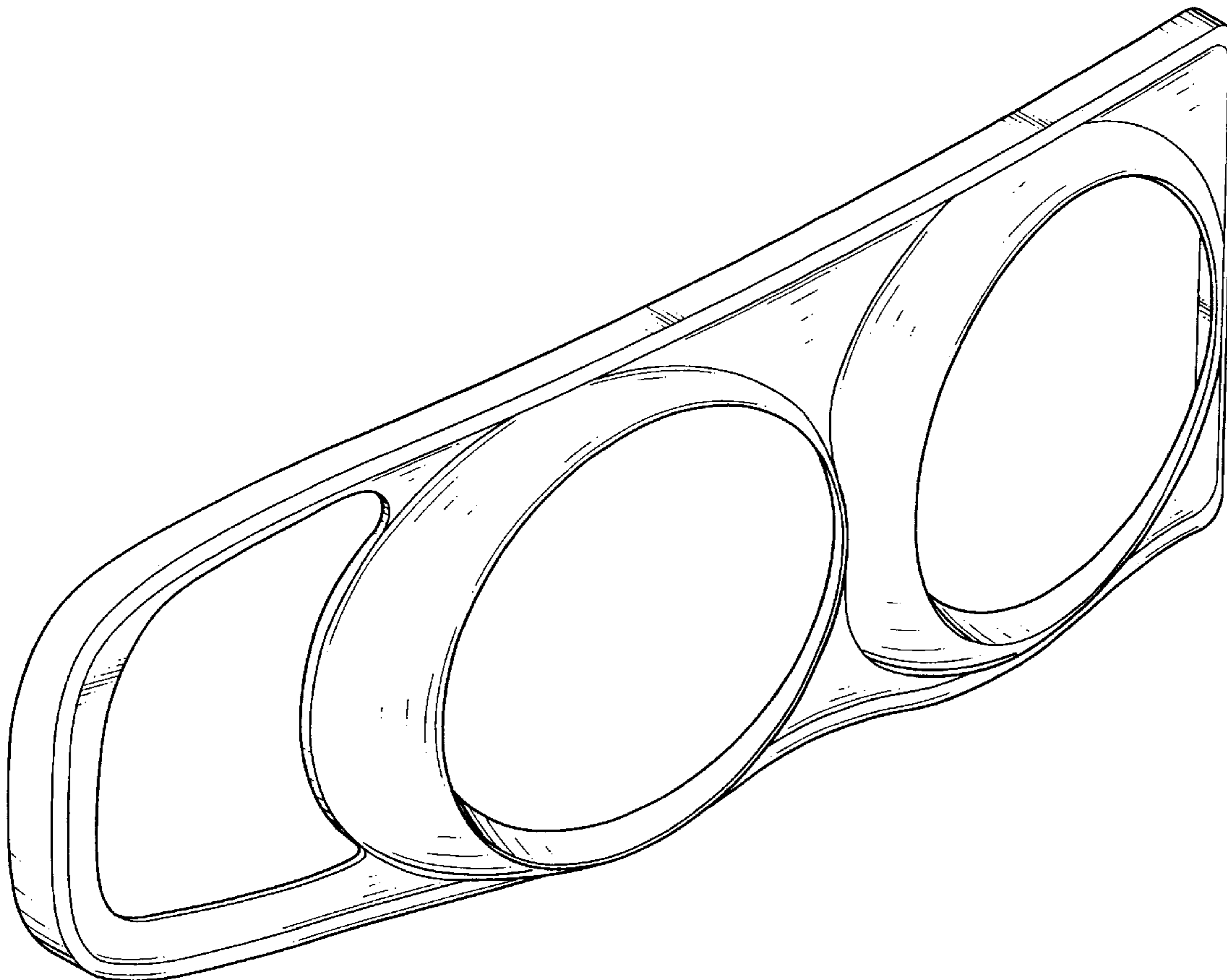

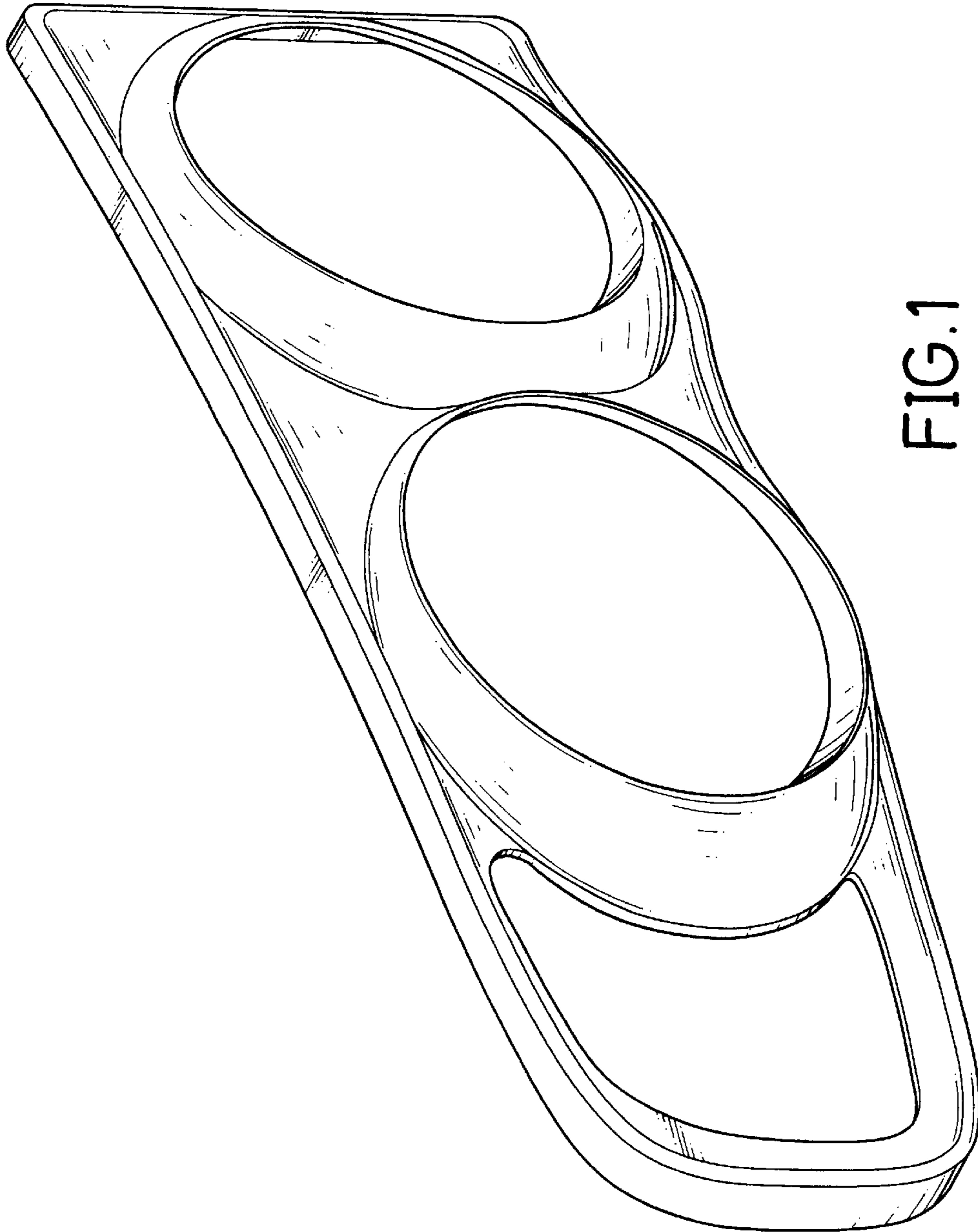

FIG.1

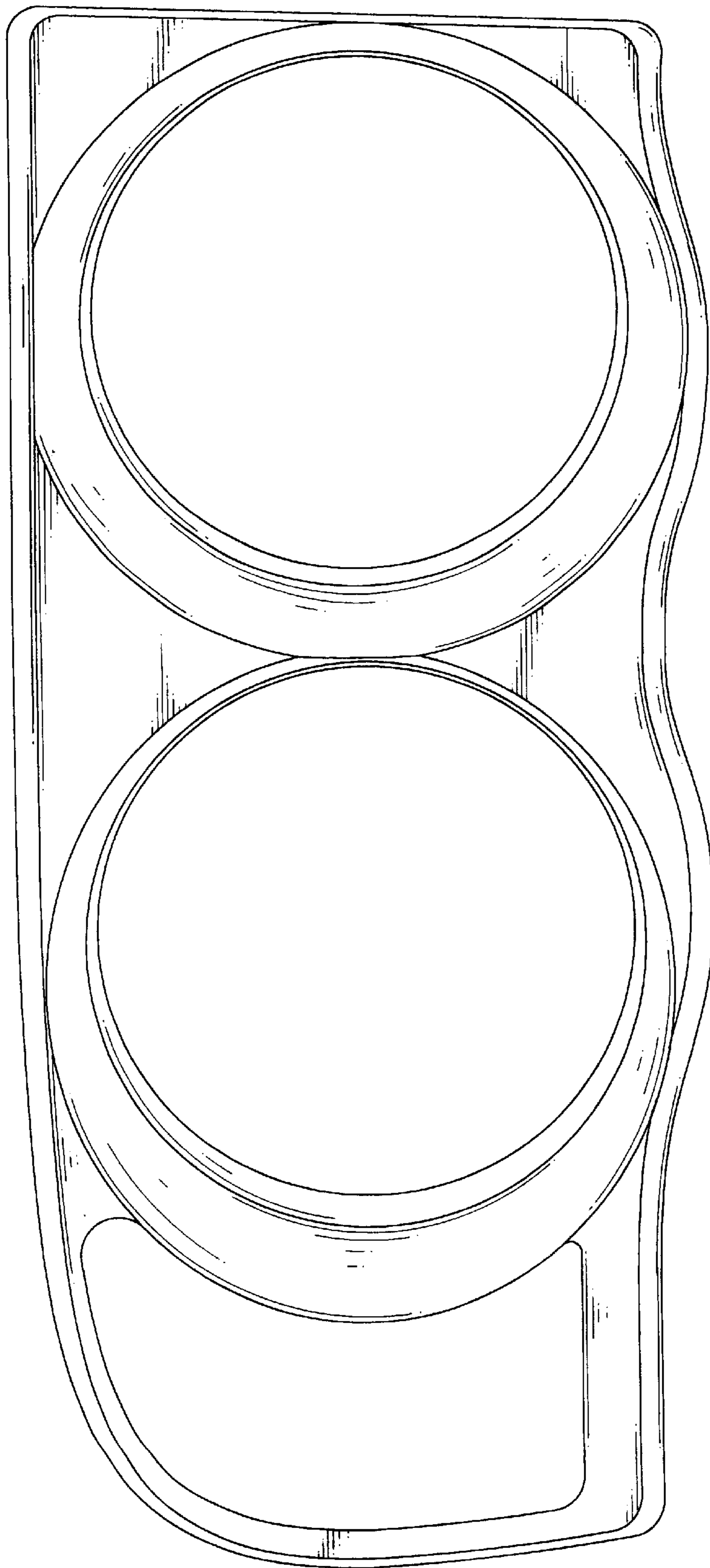

FIG. 2

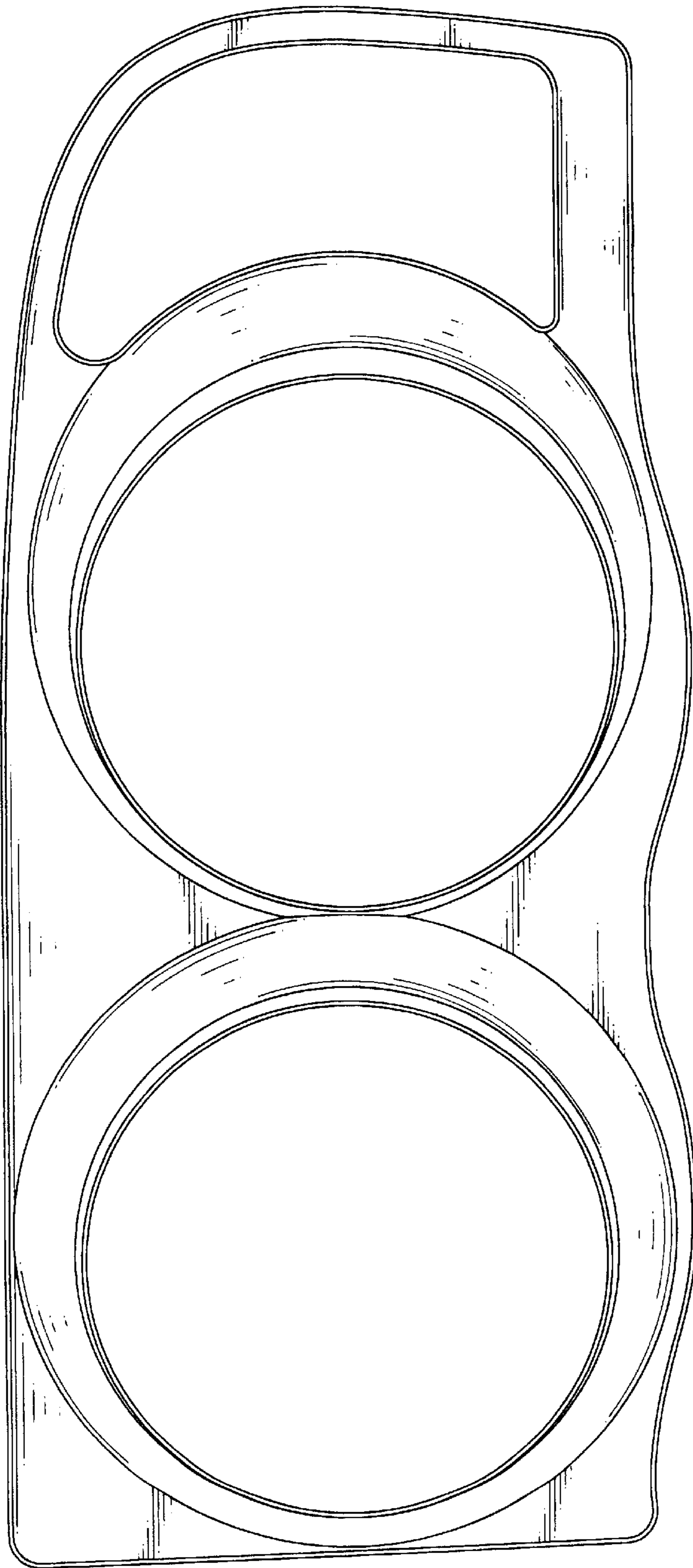

FIG. 3

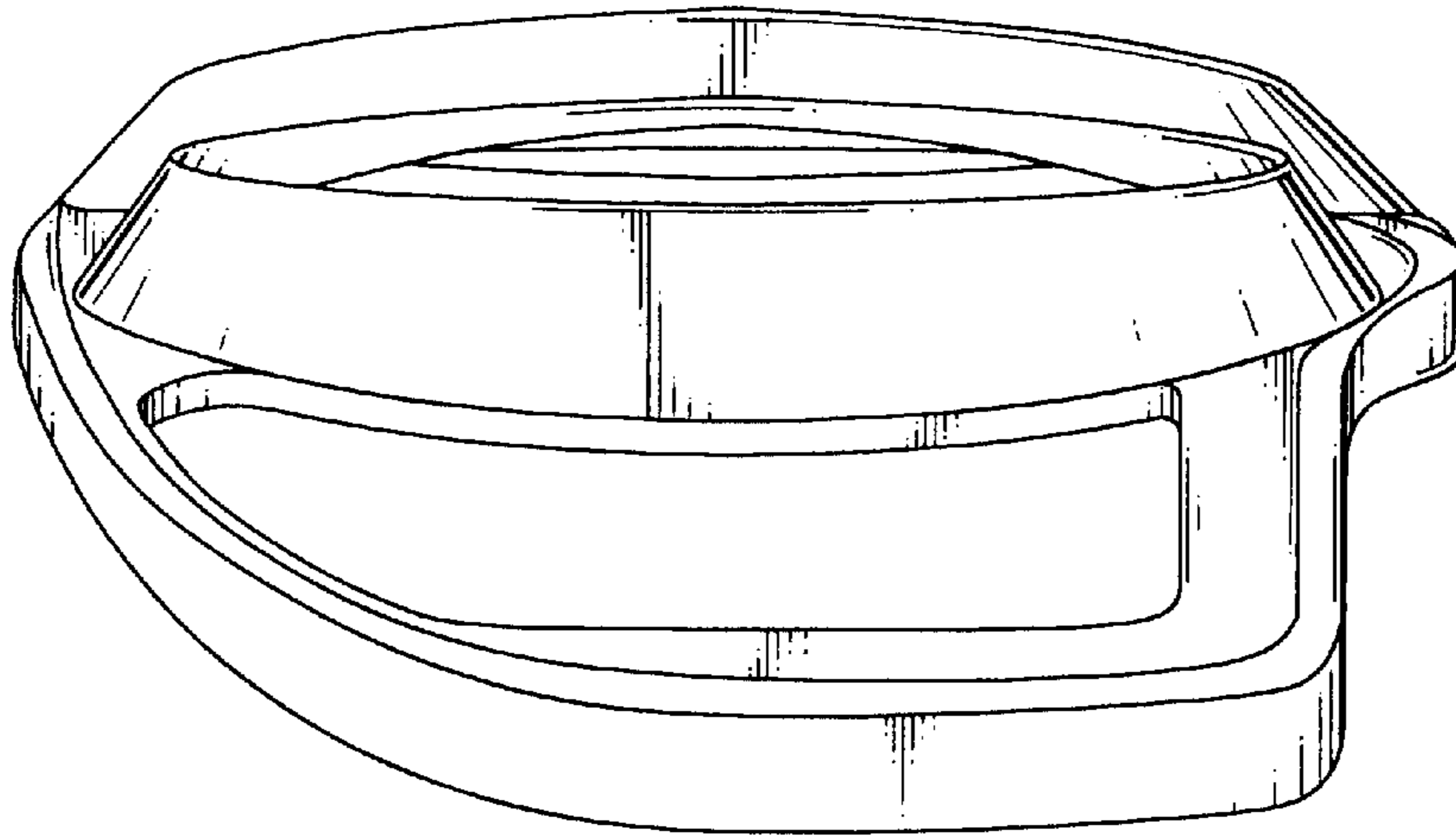

FIG. 4

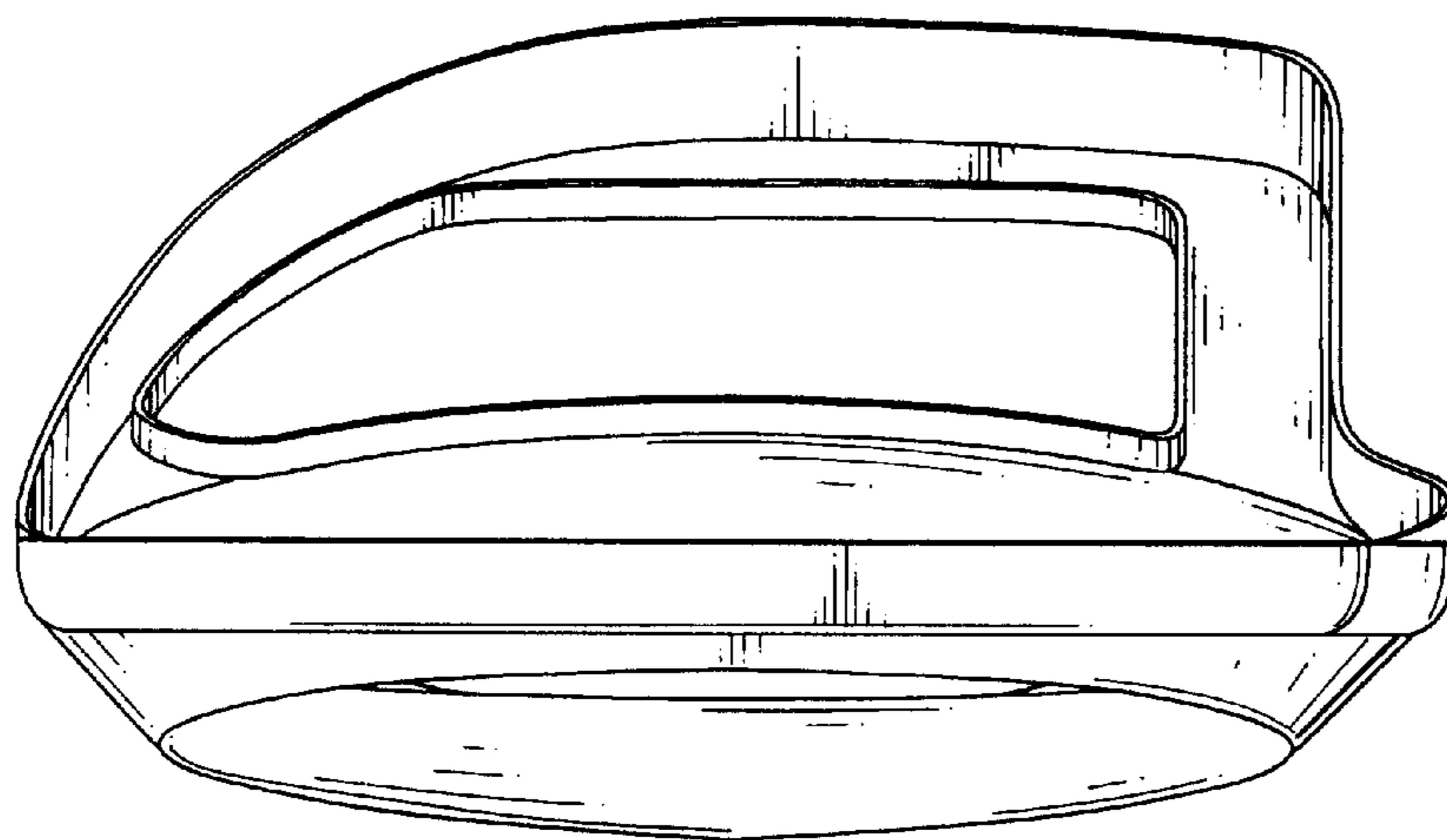

FIG. 5

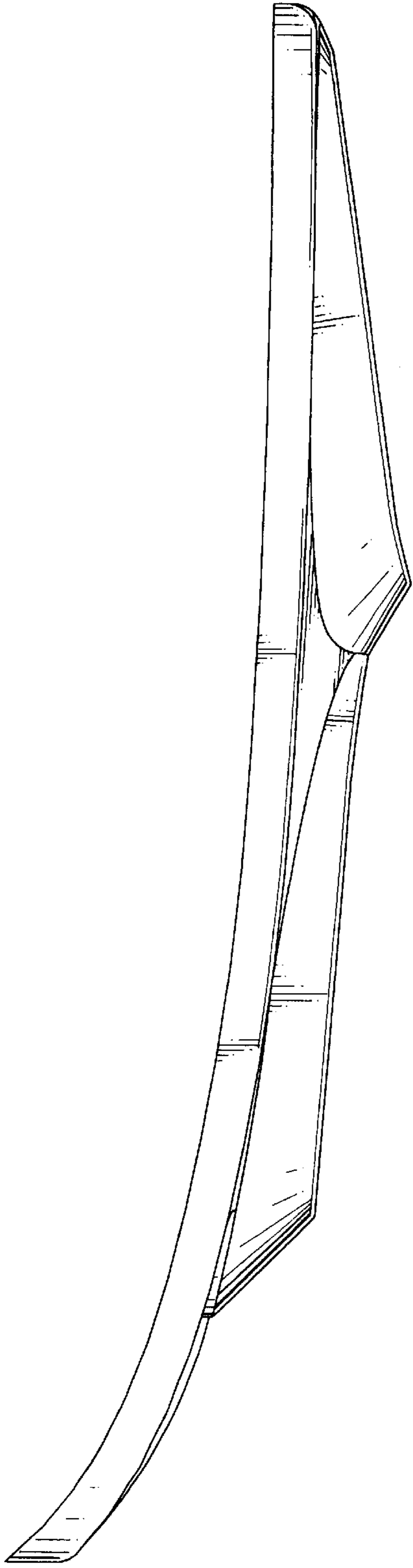

FIG. 6

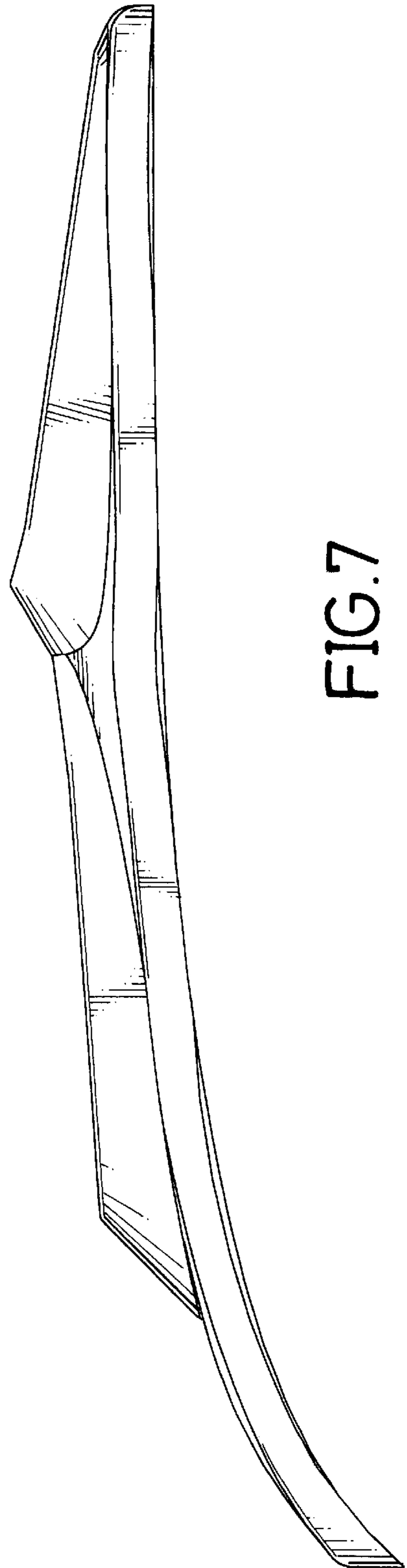

FIG. 7