



US00D485929S

(12) **United States Design Patent**
Cvek

(10) **Patent No.:** **US D485,929 S**

(45) **Date of Patent:** **** Jan. 27, 2004**

(54) **LAMP WITH PARALLEL MOVEMENT**

4,958,913 A 9/1990 Schaffer
5,097,400 A 3/1992 Cvek
5,101,332 A * 3/1992 Hsia 362/401

(76) **Inventor:** **Sava Cvek**, 40 Woodland Rd., Jamaica Plain, MA (US) 02130

(**) **Term:** **14 Years**

* cited by examiner

(21) **Appl. No.:** **29/174,063**

Primary Examiner—Pamela Burgess
Assistant Examiner—Linda Brooks
(74) *Attorney, Agent, or Firm*—O'Connell Law Firm

(22) **Filed:** **Jan. 10, 2003**

(57) **CLAIM**

(51) **LOC (7) Cl.** **26-05**

I claim the ornamental design for a lamp with parallel movement, as shown.

(52) **U.S. Cl.** **D26/65**

(58) **Field of Search** D26/61-66; 362/277-282, 362/285, 287, 401, 402, 410-414, 418, 419, 427, 428, 431

DESCRIPTION

(56) **References Cited**

U.S. PATENT DOCUMENTS

D284,087 S	6/1986	Haidinger	
D285,120 S	8/1986	Krogsrud	
D295,287 S	4/1988	Krogsrud et al.	
4,744,019 A	5/1988	Krogsrud	
D310,886 S	* 9/1990	Gismondi et al. D26/65

FIG. 1 is a perspective view of a lamp according to my new design;
FIG. 2 is a view in side elevation of the lamp of FIG. 1;
FIG. 3 is a view in front elevation of the lamp of FIG. 1;
FIG. 4 is a view in rear elevation of the lamp of FIG. 1;
FIG. 5 is a top plan view of the lamp of FIG. 1; and,
FIG. 6 is a bottom plan view of the lamp of FIG. 1.

1 Claim, 3 Drawing Sheets

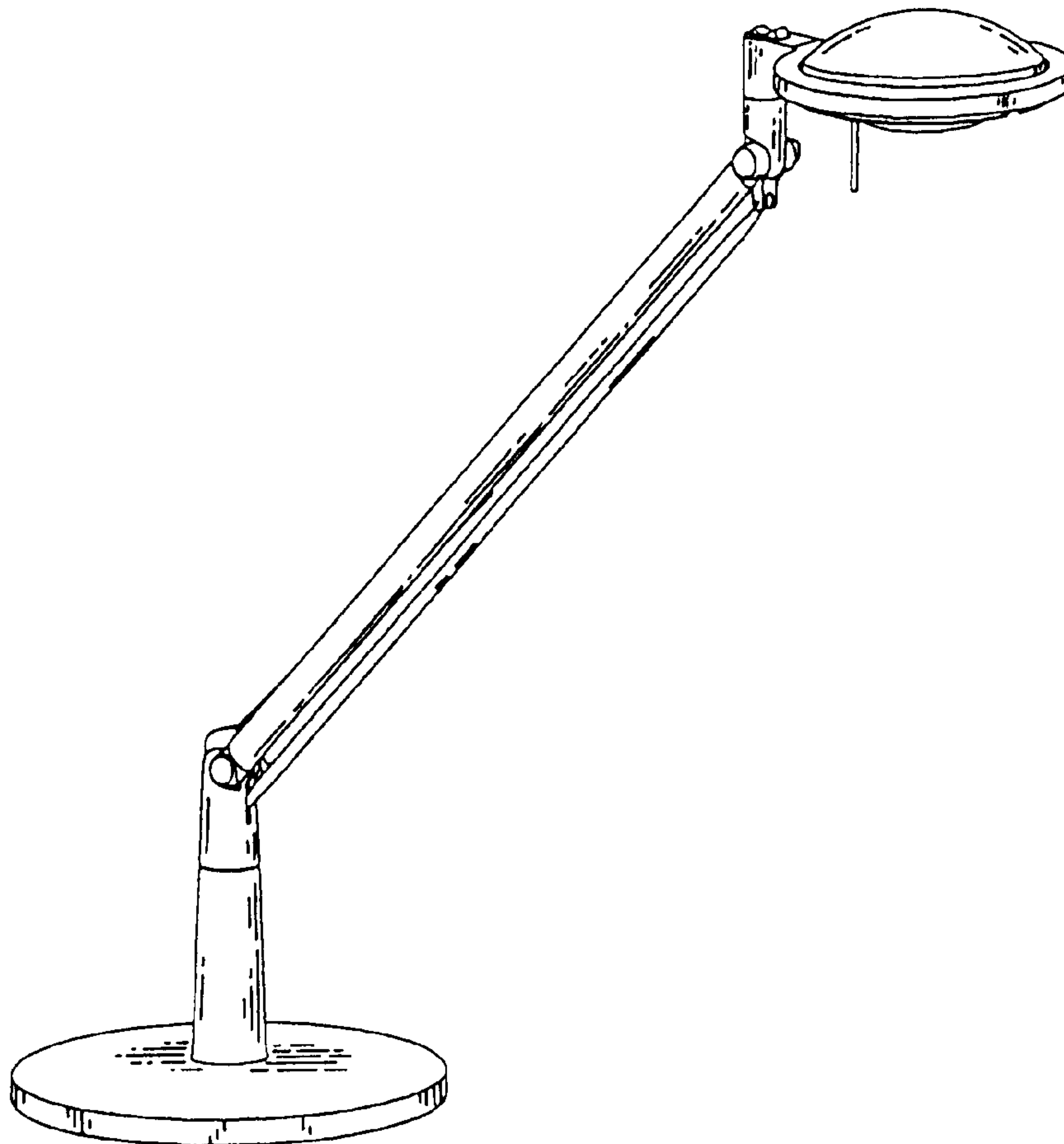

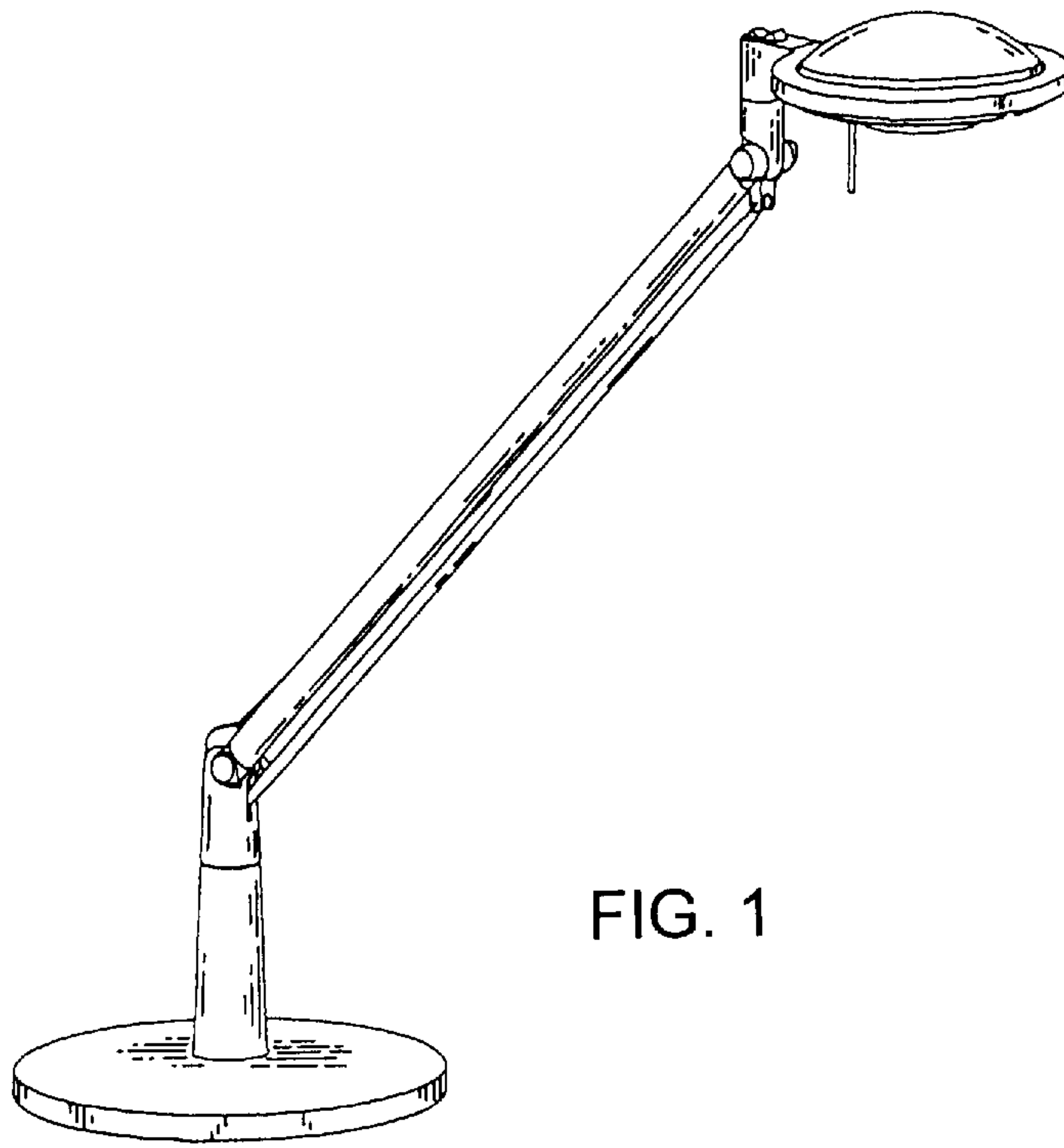

FIG. 1

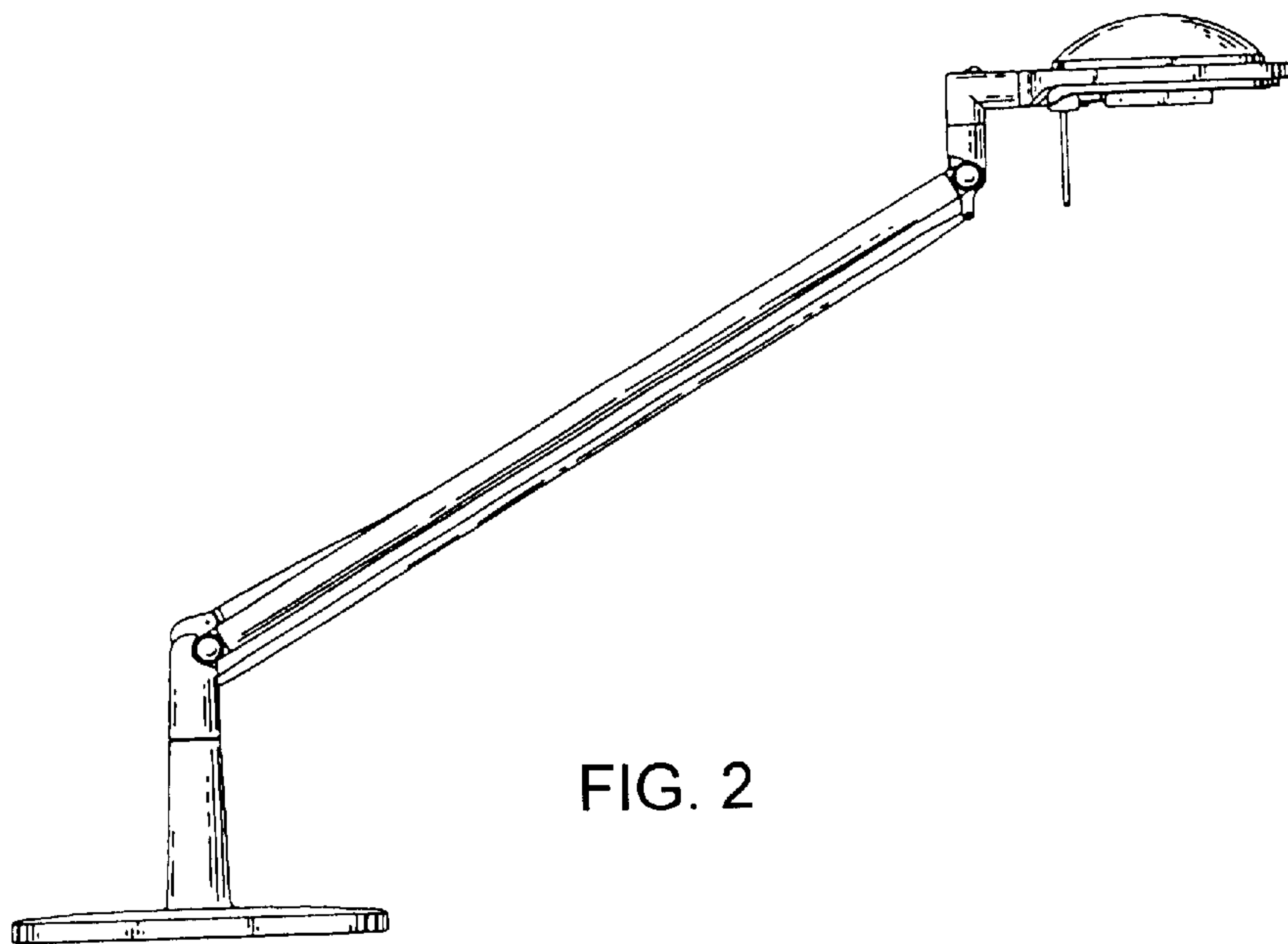

FIG. 2

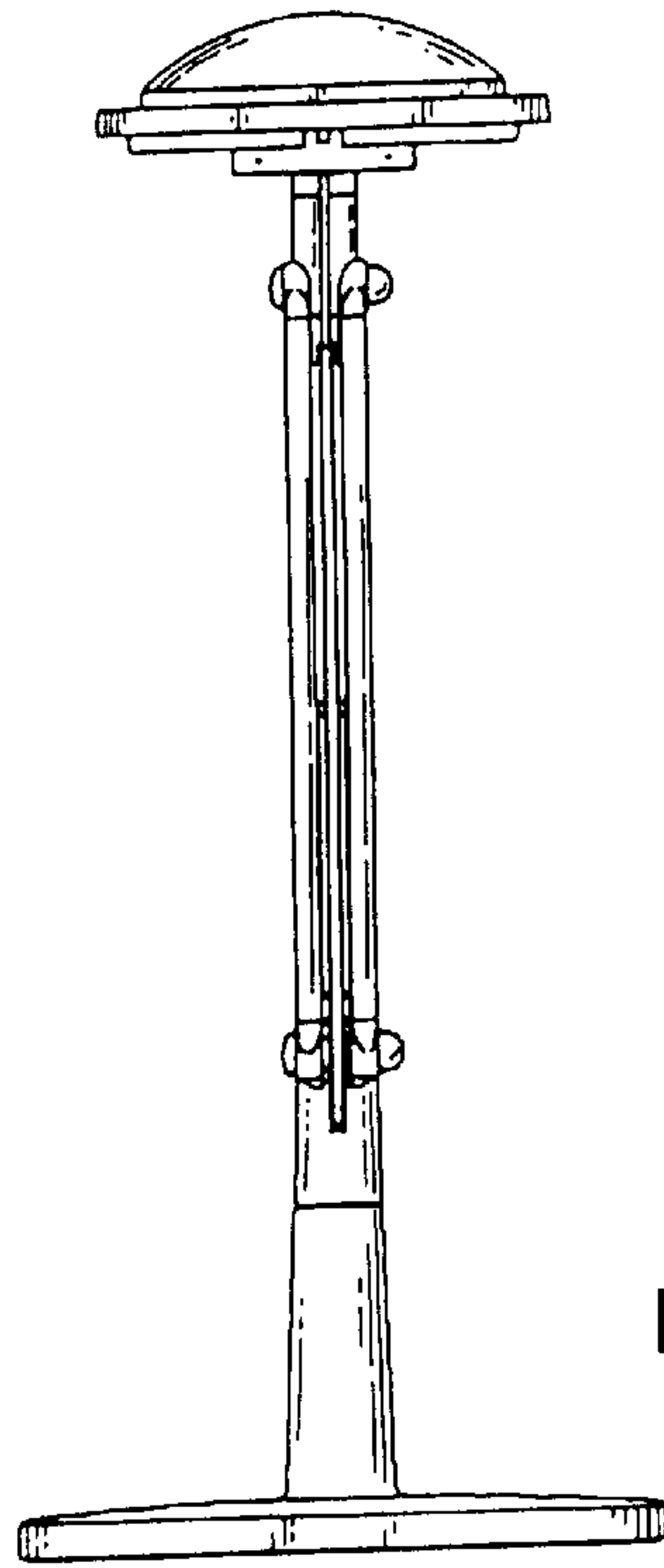

FIG. 3

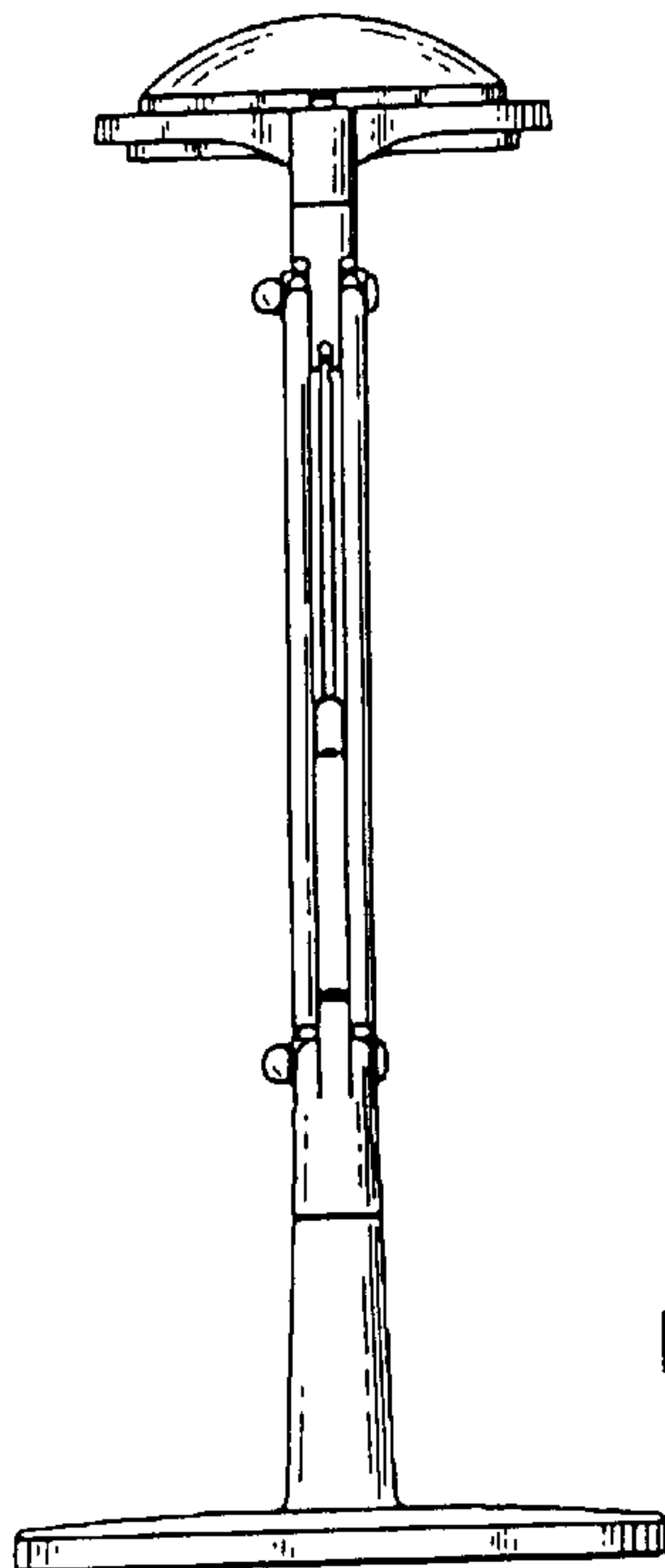

FIG. 4

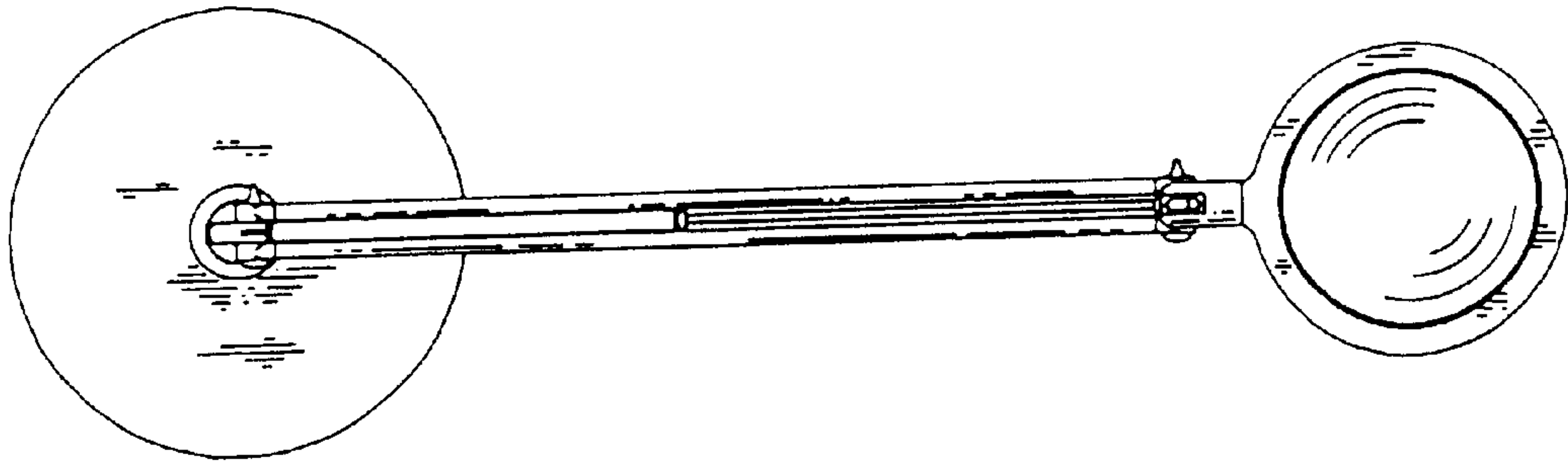

FIG. 5

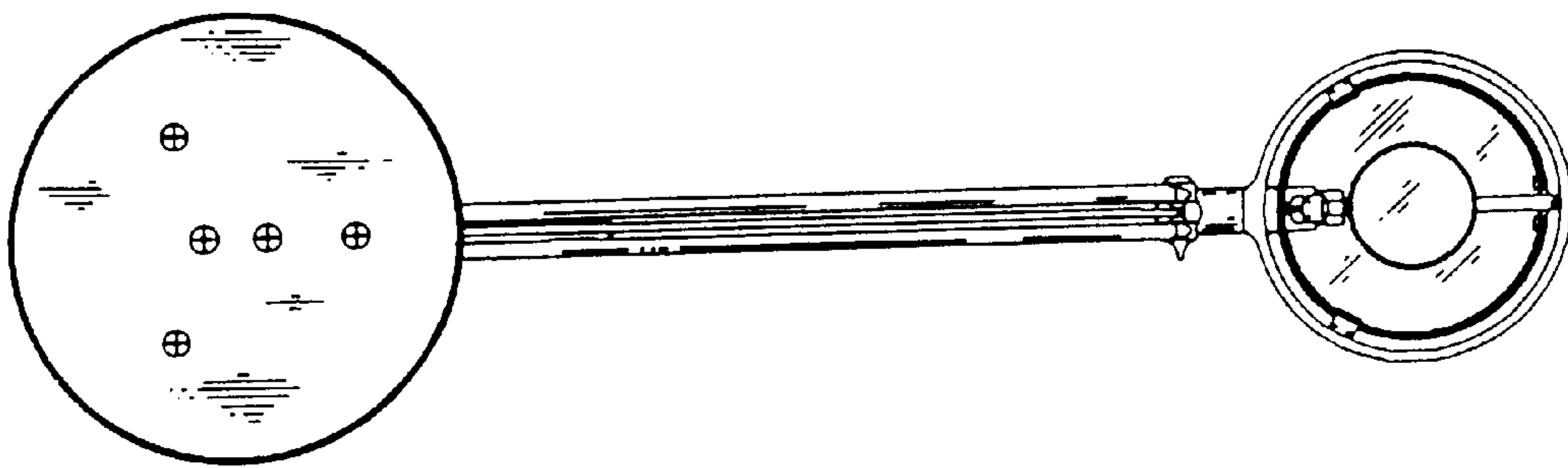

FIG. 6