



US00D485631S

(12) **United States Design Patent**
Campman

(10) **Patent No.:** **US D485,631 S**

(45) **Date of Patent:** **** Jan. 20, 2004**

(54) **LITE TRACKER WITH SIX LED LIGHTS**

(76) **Inventor:** **James P. Campman**, P.O. Box 167,
Transfer, PA (US) 16154

(**) **Term:** **14 Years**

(21) **Appl. No.:** **29/177,127**

(22) **Filed:** **Mar. 5, 2003**

(51) **LOC (7) Cl.** **26-02**

(52) **U.S. Cl.** **D26/39**

(58) **Field of Search** D26/37-50; 362/157,
362/158, 171, 172, 173, 183-208

(56) **References Cited**

U.S. PATENT DOCUMENTS

D354,577 S	*	1/1995	Cota et al.	D26/39
D362,079 S	*	9/1995	Brown	D26/39
D362,312 S	*	9/1995	Chen	D26/39
D371,617 S	*	7/1996	Anwyl-Davies	D26/39
D392,403 S	*	3/1998	Benensohn	D26/39

* cited by examiner

Primary Examiner—Marcus A. Jackson

(74) *Attorney, Agent, or Firm*—Birch, Stewart, Kolasch & Birch, LLP

(57) **CLAIM**

The ornamental design for a lite tracker with six LED lights, as shown and described.

DESCRIPTION

FIG. 1 is a perspective view of a lite tracker with six LED lights embodying my design;
 FIG. 2 is a perspective top view of the lite tracker with six LED lights as shown in FIG. 1;
 FIG. 3 is a top view of the lite tracker with six LED lights as shown in FIG. 1;
 FIG. 4 is a bottom view of the lite tracker with six LED lights as shown in FIG. 1;
 FIG. 5 is a side view of the lite tracker with six LED lights as shown in FIG. 1;
 FIG. 6 is a front view of the lite tracker with six LED lights as shown in FIG. 1; and,
 FIG. 7 is a back view of the lite tracker with six LED lights as shown in FIG. 1.

1 Claim, 3 Drawing Sheets

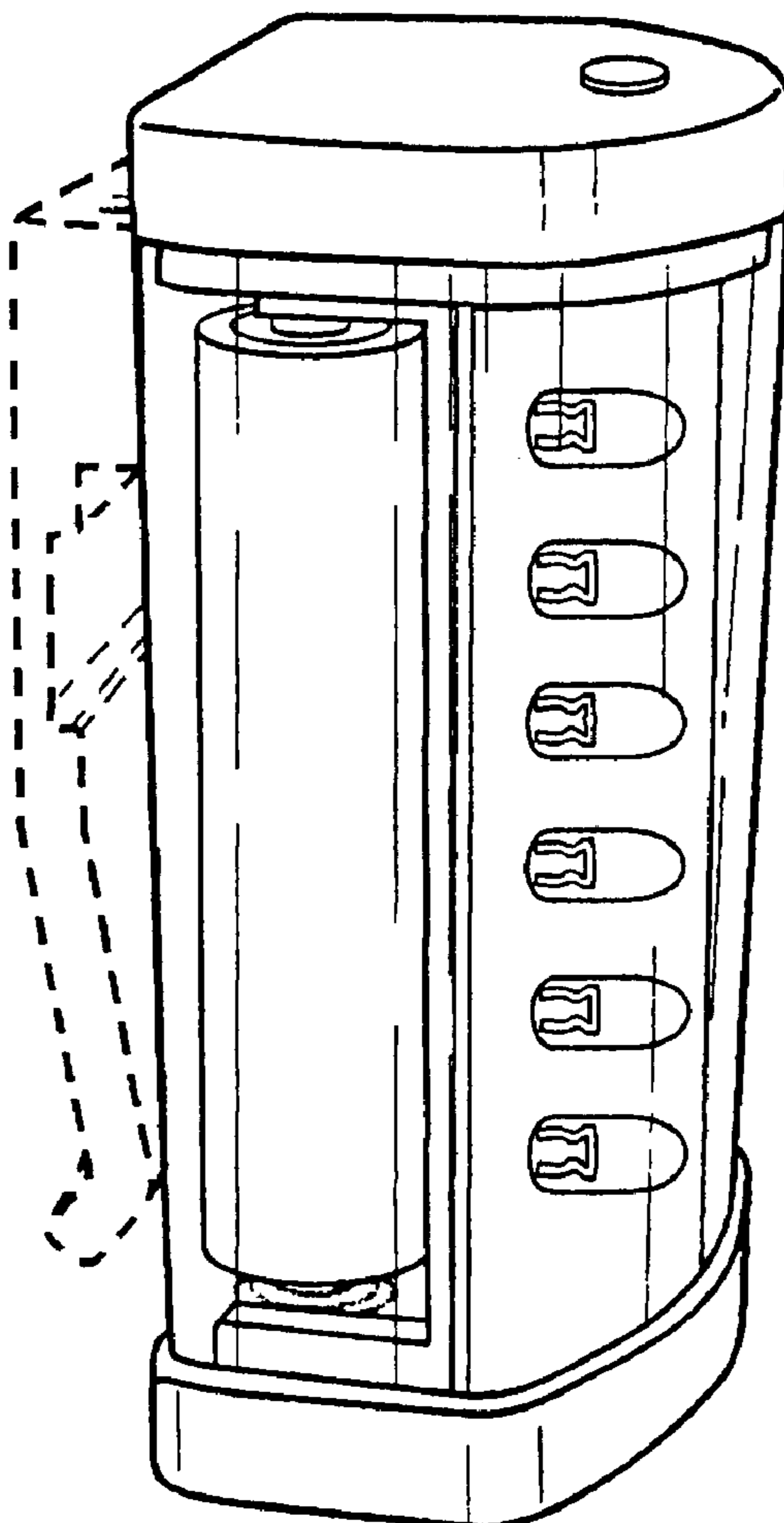

FIG. 1

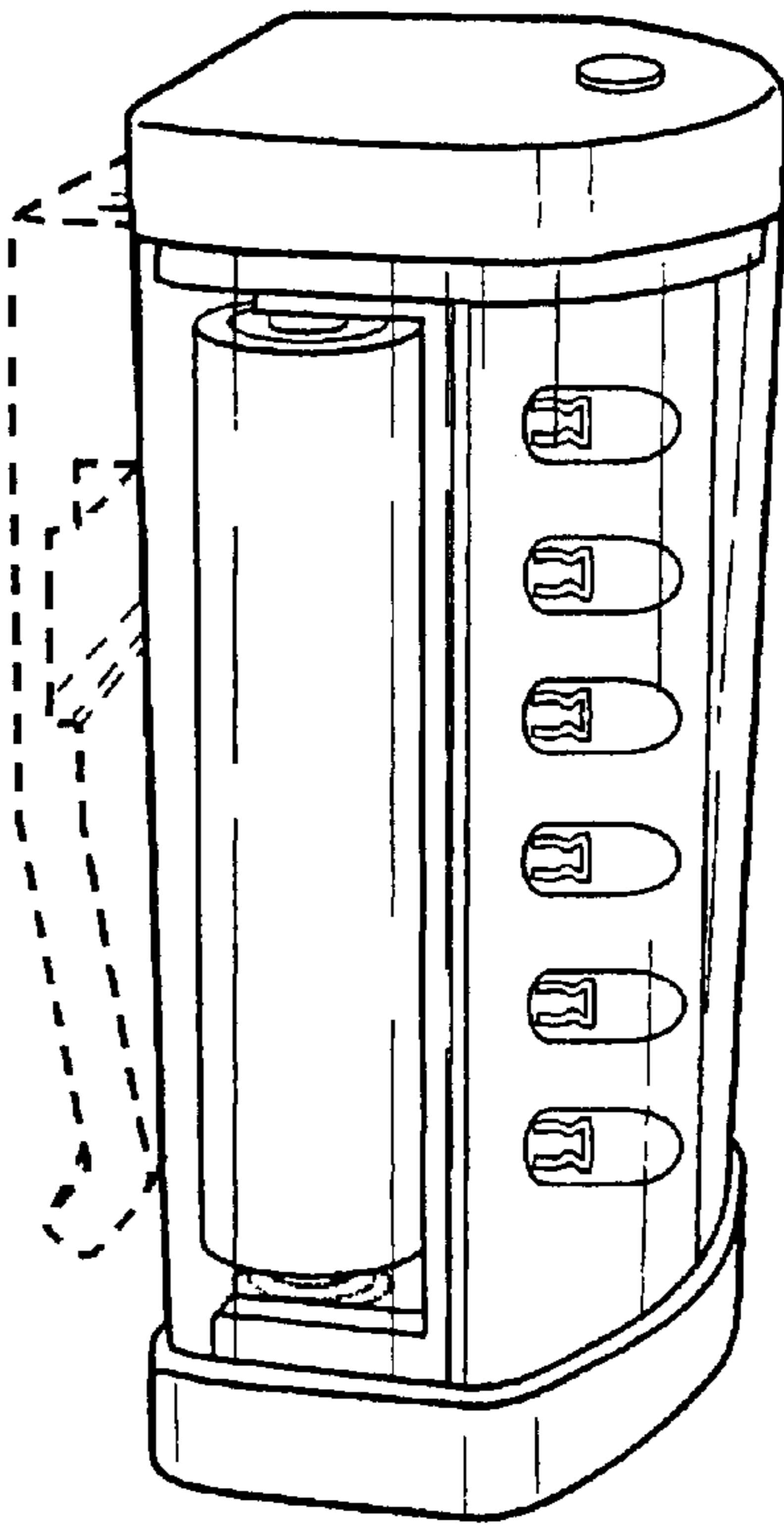

FIG. 2

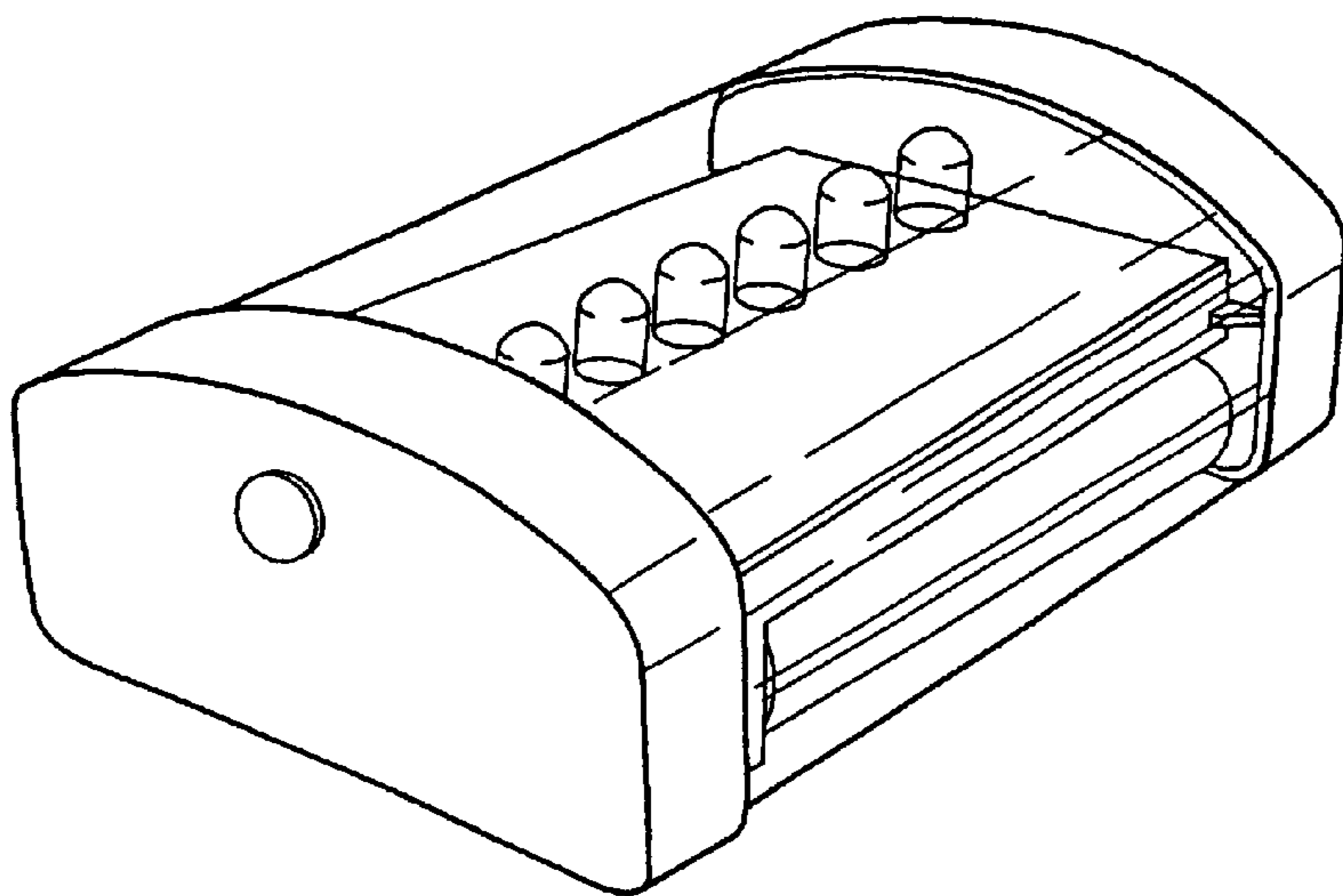

FIG. 3

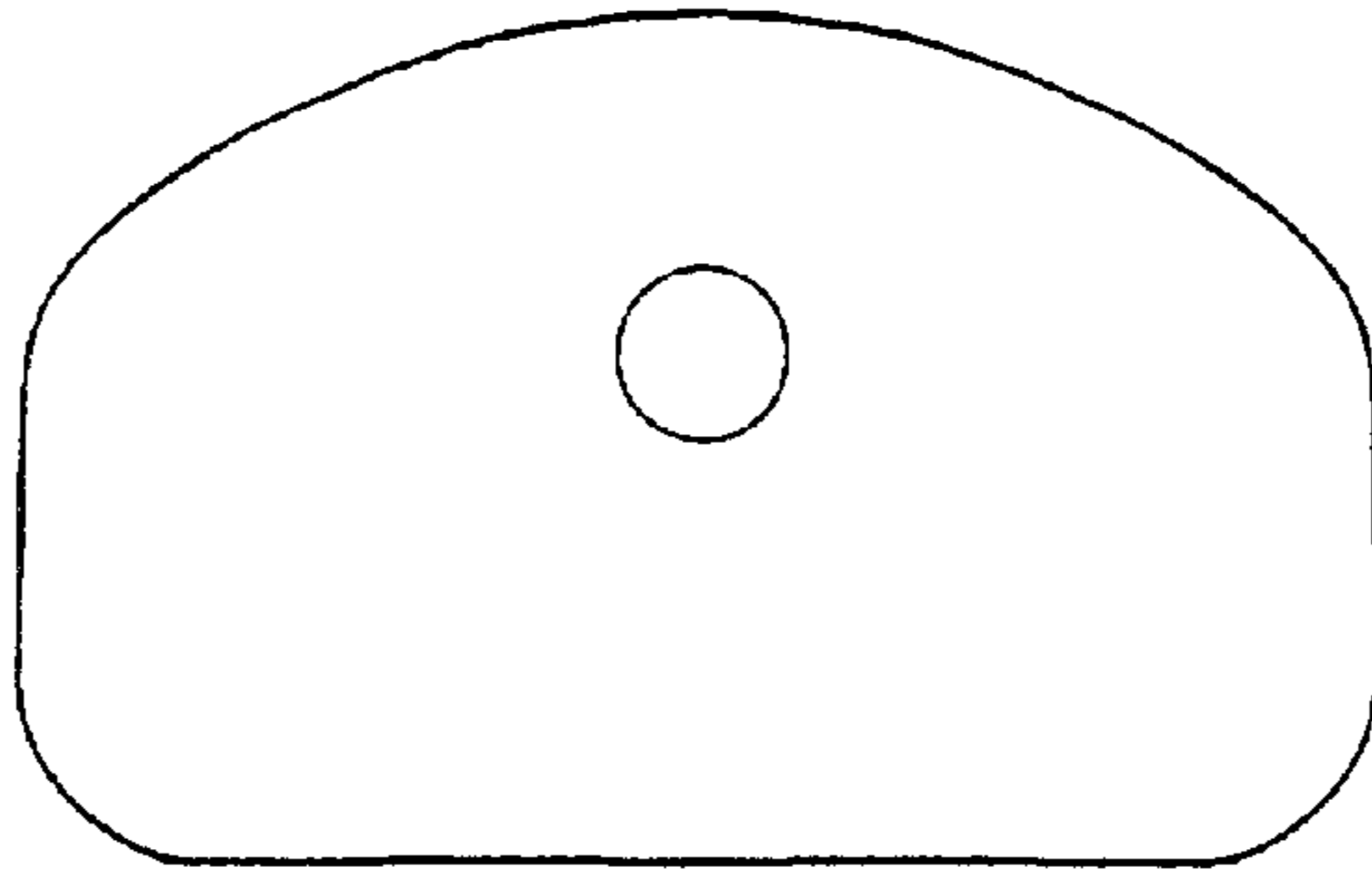

FIG. 4

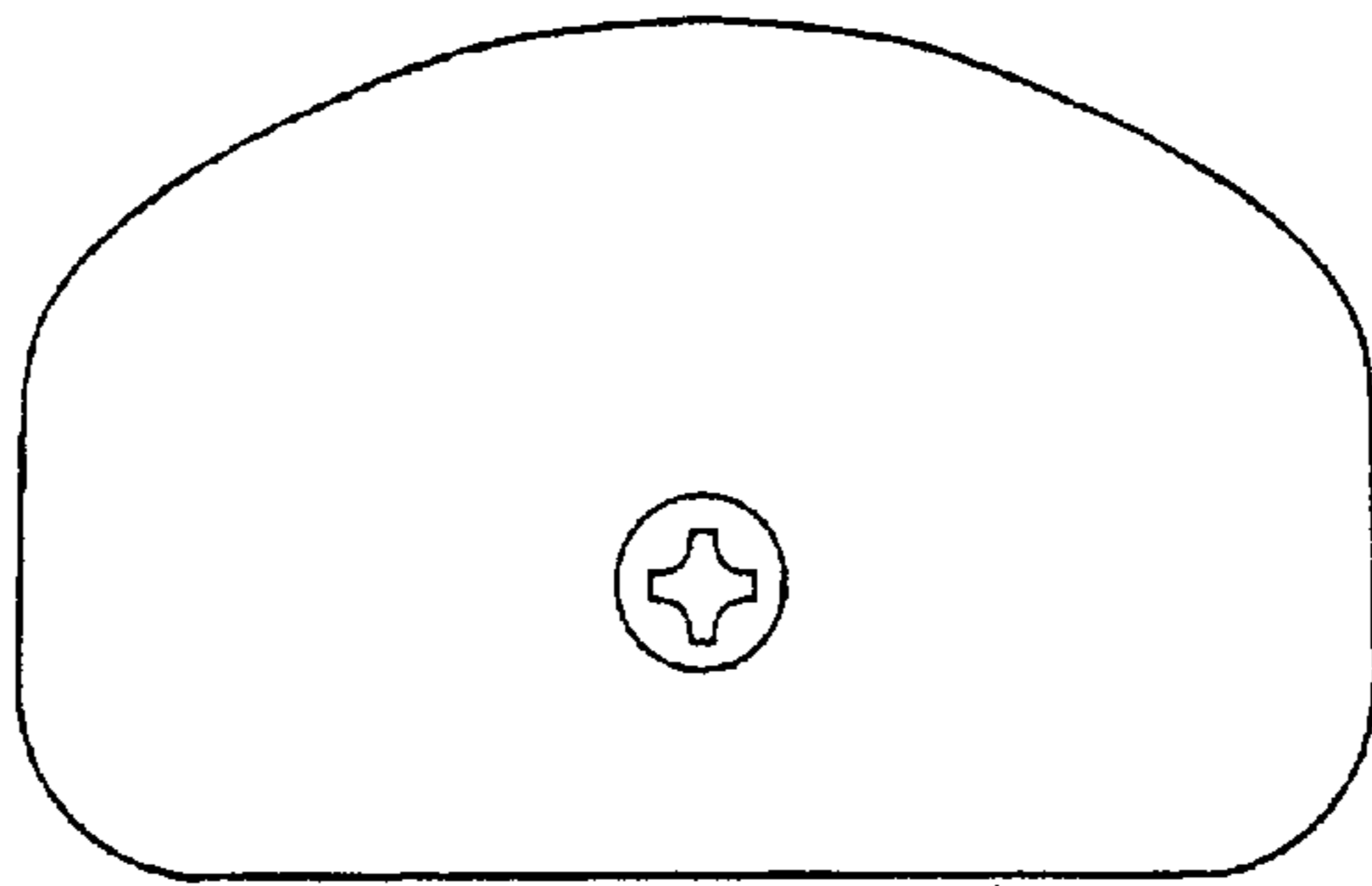

FIG. 5

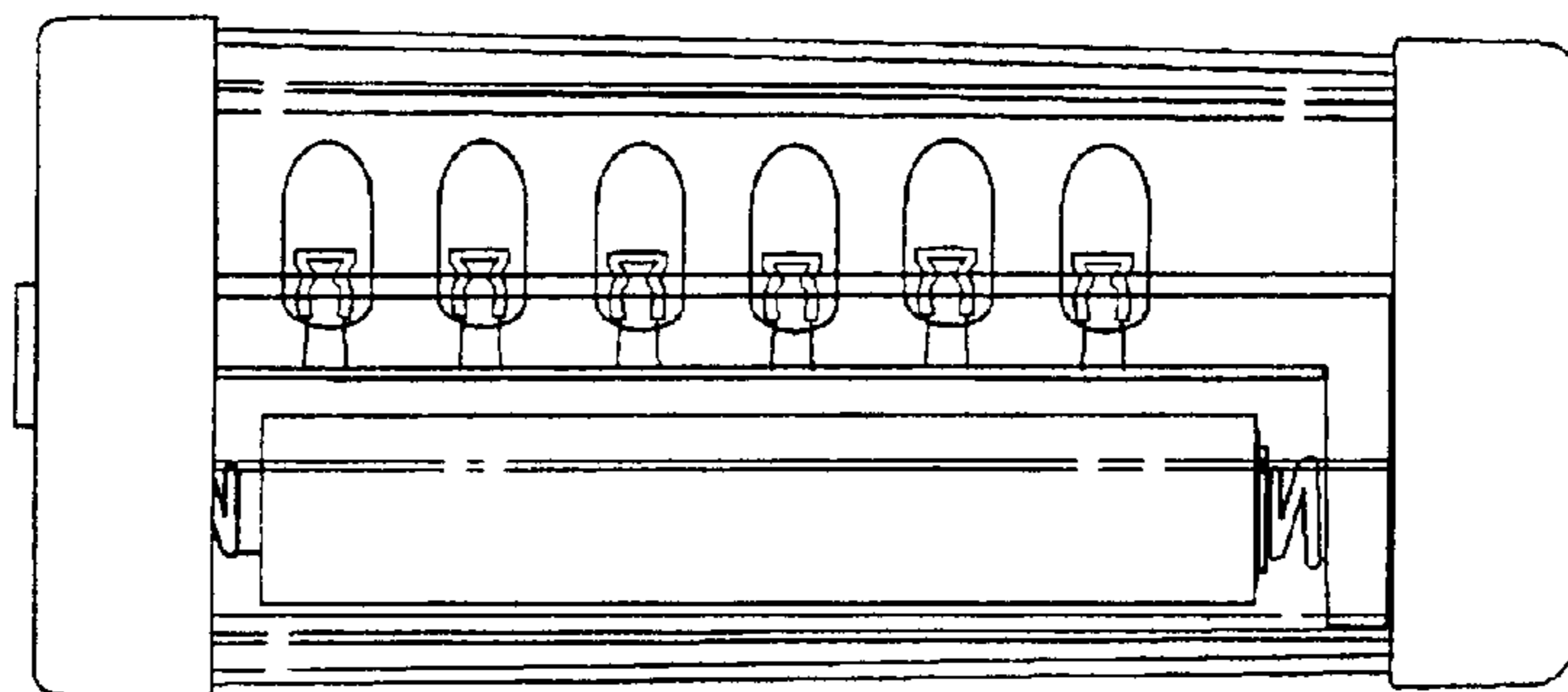

FIG. 6

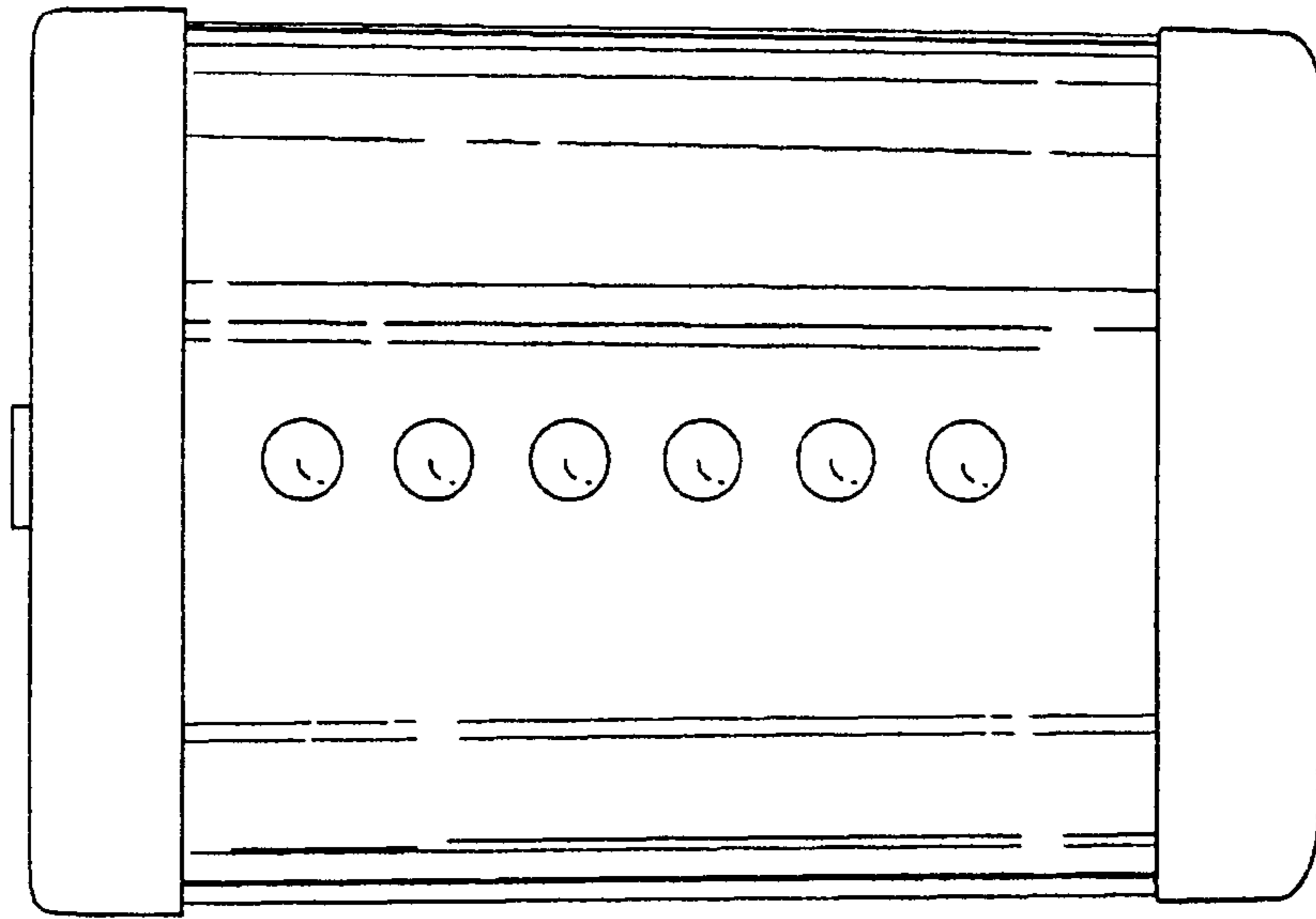

FIG. 7

