



US00D485626S

(12) **United States Design Patent**
Parker

(10) **Patent No.: US D485,626 S**

(45) **Date of Patent: ** *Jan. 20, 2004**

(54) **FLASHLIGHT**

(75) Inventor: **David H. Parker**, Torrance, CA (US)

(73) Assignee: **Pelican Products, Inc.**, Torrance, CA (US)

(*) Notice: This patent is subject to a terminal disclaimer.

(**) Term: **14 Years**

(21) Appl. No.: **29/149,774**

(22) Filed: **Oct. 15, 2001**

Related U.S. Application Data

(63) Continuation-in-part of application No. 29/136,823, filed on Feb. 7, 2001, now Pat. No. Des. 449,394.

(51) **LOC (7) Cl.** **26-02**

(52) **U.S. Cl.** **D26/37**

(58) **Field of Search** D26/37-50; 362/157, 362/158, 171, 172, 173, 183-208

(56) **References Cited**

U.S. PATENT DOCUMENTS

D449,394 S * 10/2001 Parker D26/37

* cited by examiner

Primary Examiner—Marcus A. Jackson

(74) *Attorney, Agent, or Firm*—Greenberg Traurig, LLP; Charles Berman, Esq.

(57) **CLAIM**

The ornamental design for a flashlight, as shown and described.

DESCRIPTION

FIG. 1 is a perspective view from the front of the flashlight; FIG. 2 is a side view from the front of the flashlight; FIG. 3 is a front view from the front of the flashlight; FIG. 4 is a rear view from the front of the flashlight; FIG. 5 is a top view from the front of the flashlight; and, FIG. 6 is an under view from the front of the flashlight. FIG. 7 is a perspective view from the front of the alternative embodiment of the flashlight; FIG. 8 is a side view from the front of the alternative embodiment of the flashlight; FIG. 9 is a front view from the front of the alternative embodiment of the flashlight; FIG. 10 is a rear view from the front of the alternative embodiment of the flashlight; FIG. 11 is a top view from the front of the alternative embodiment of the flashlight; FIG. 12 is an under view from the front of the alternative embodiment of the flashlight; FIG. 13 is a perspective view from the front of a further alternative embodiment of the flashlight; and, FIG. 14 is a perspective view from the front of a further alternative embodiment of the flashlight.

1 Claim, 6 Drawing Sheets

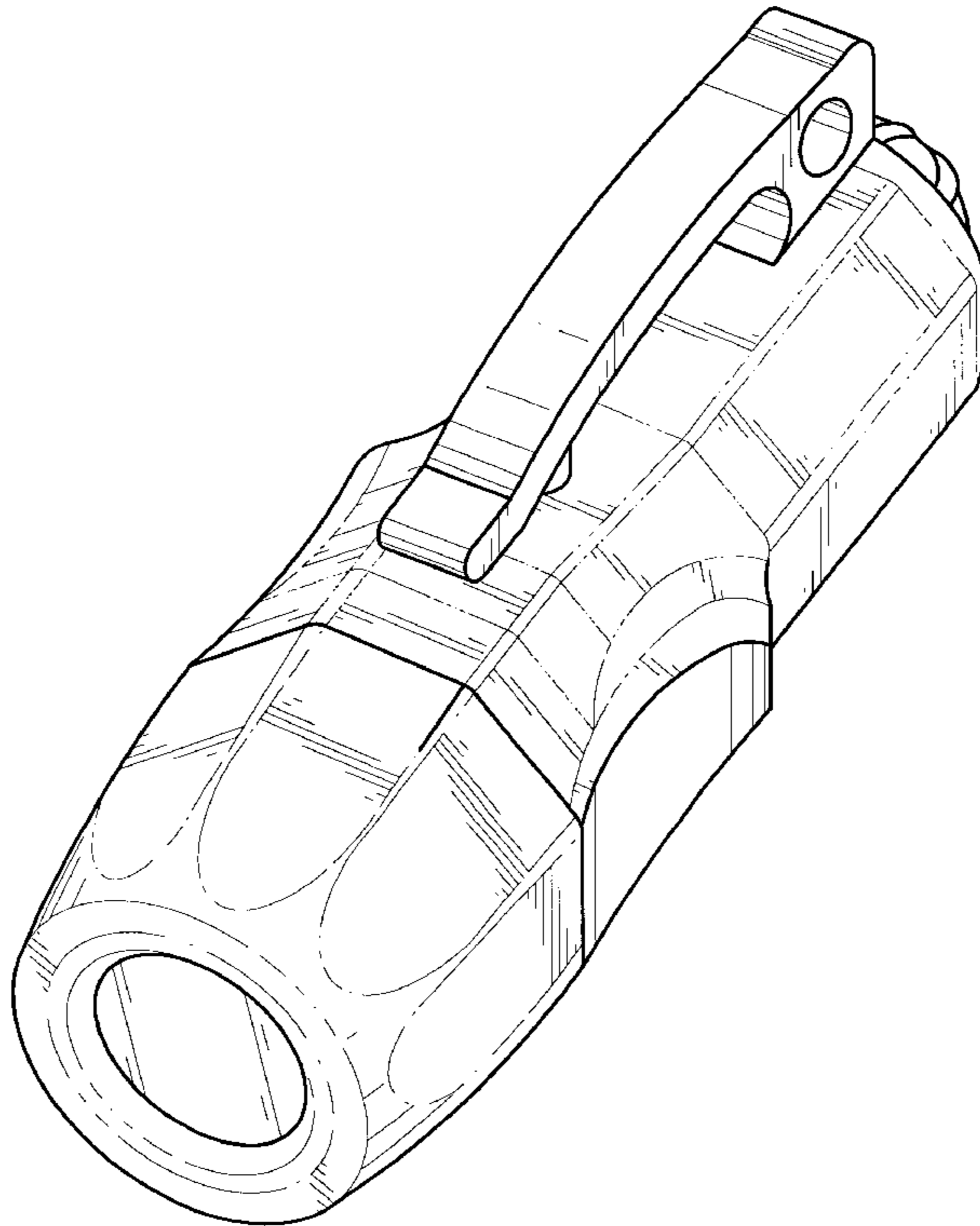
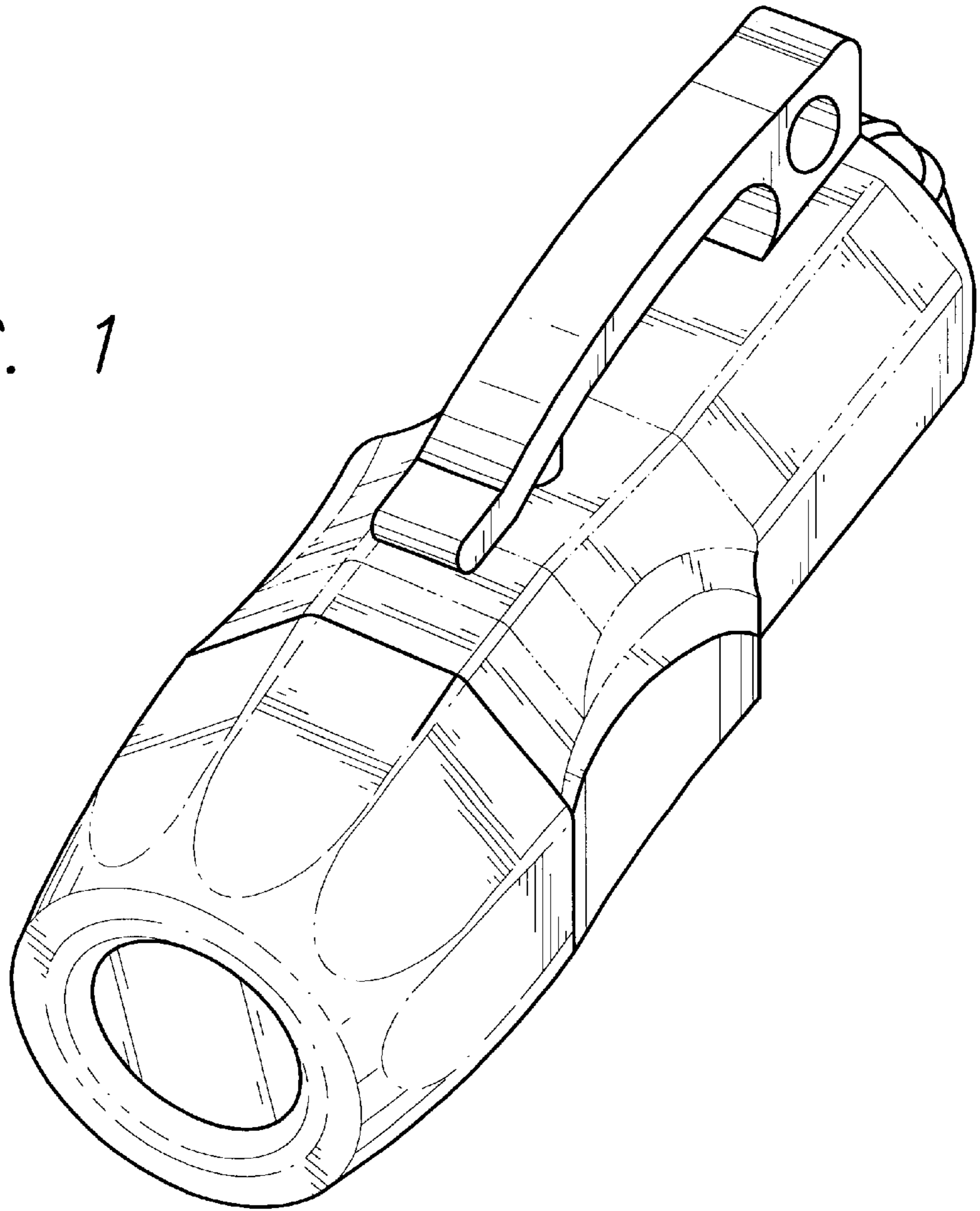

FIG. 1



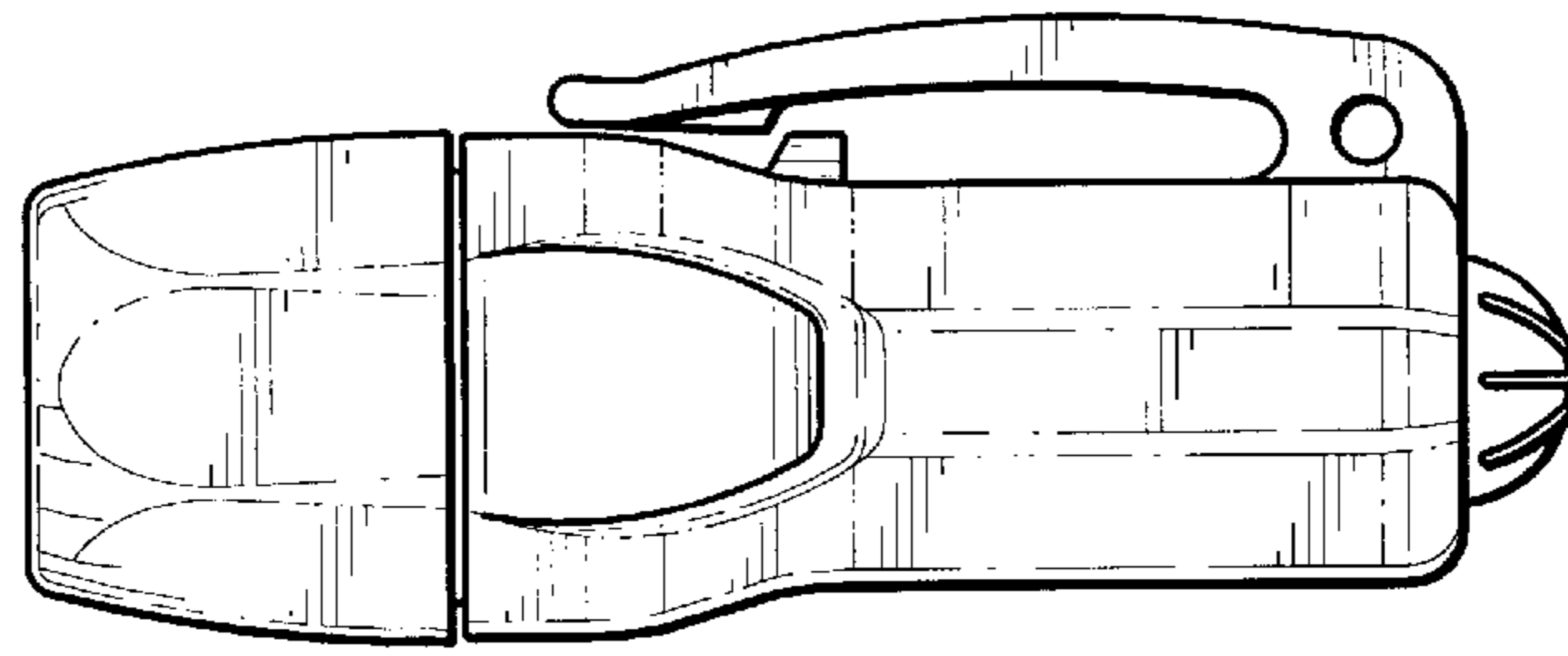

FIG. 2

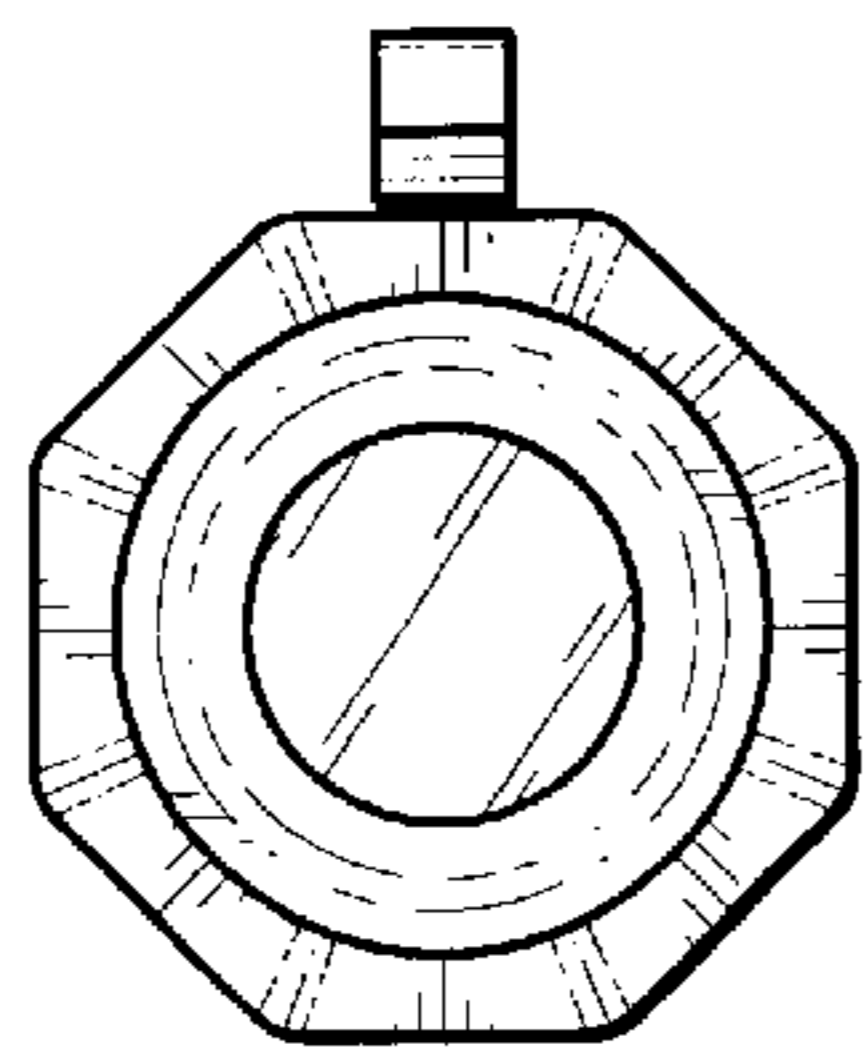

FIG. 3

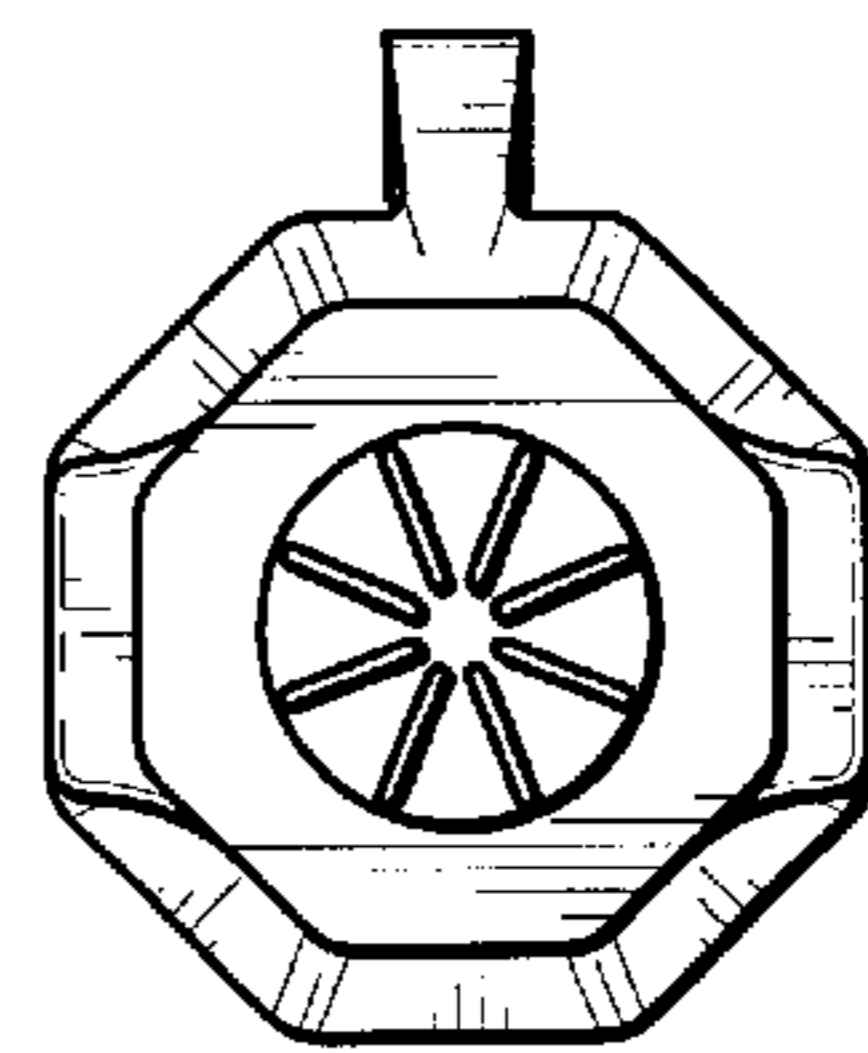

FIG. 4

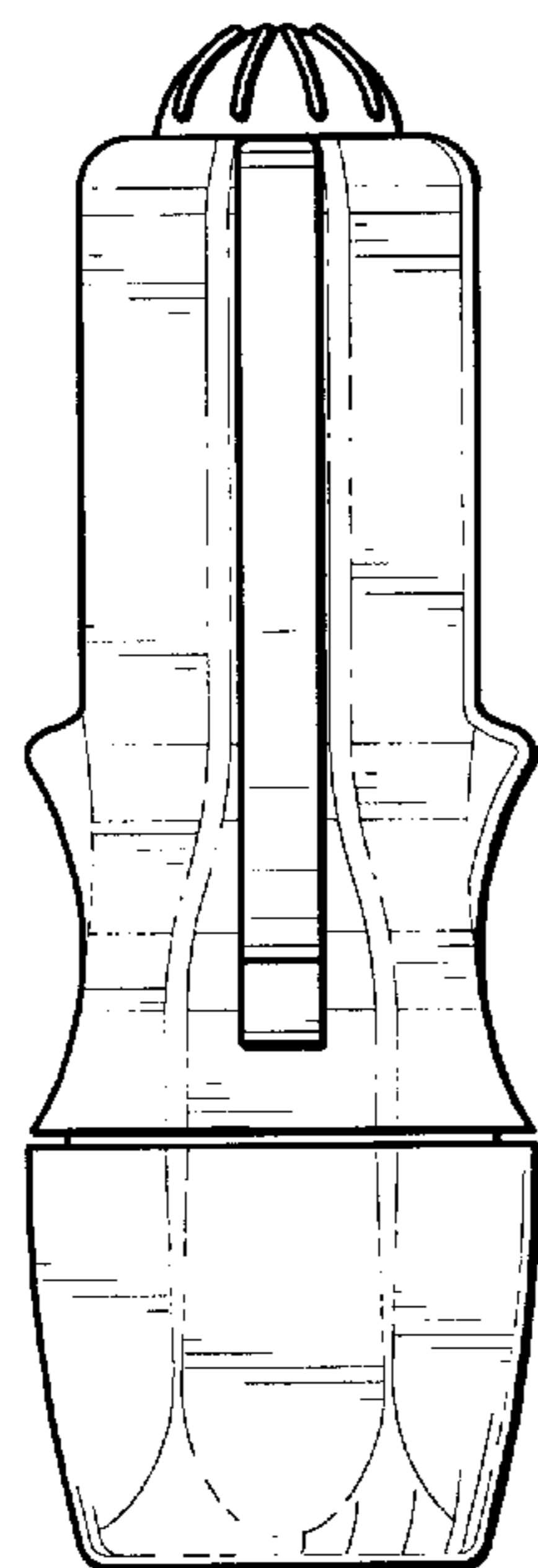

FIG. 5

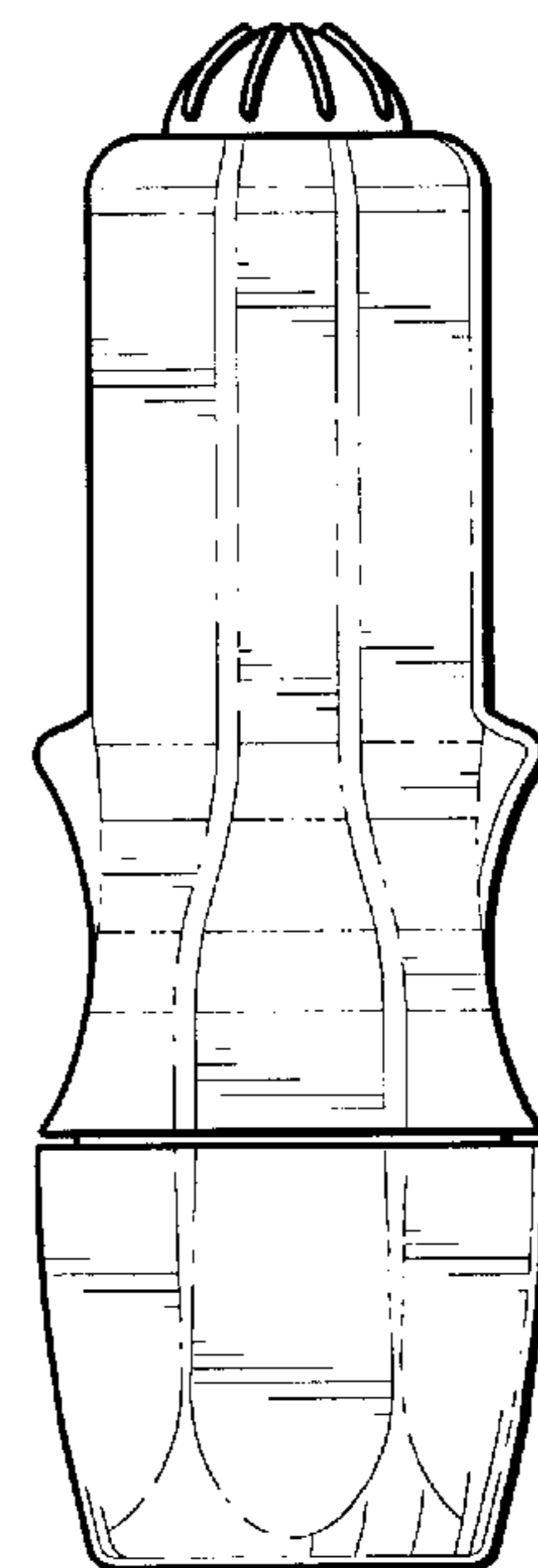
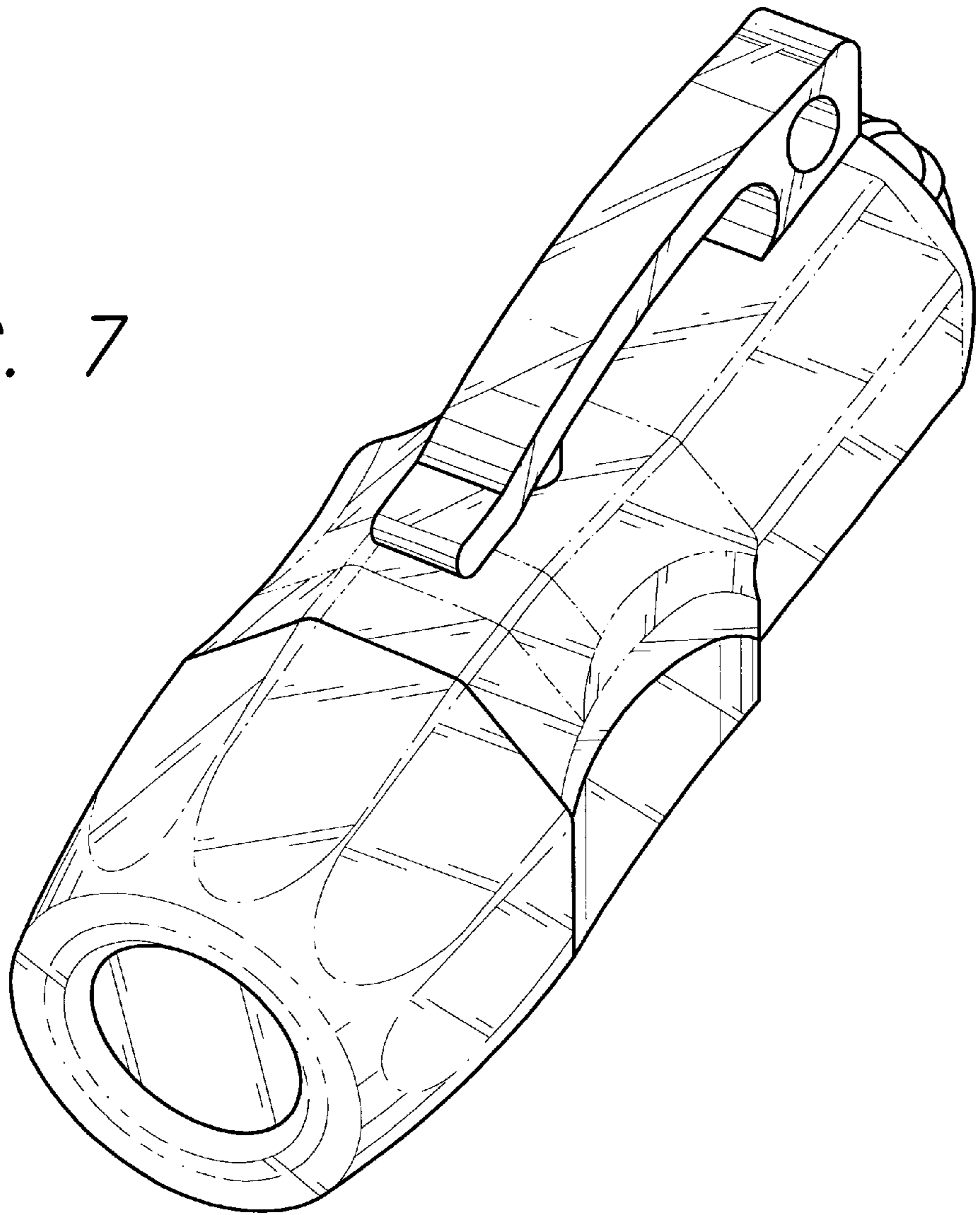

FIG. 6

FIG. 7



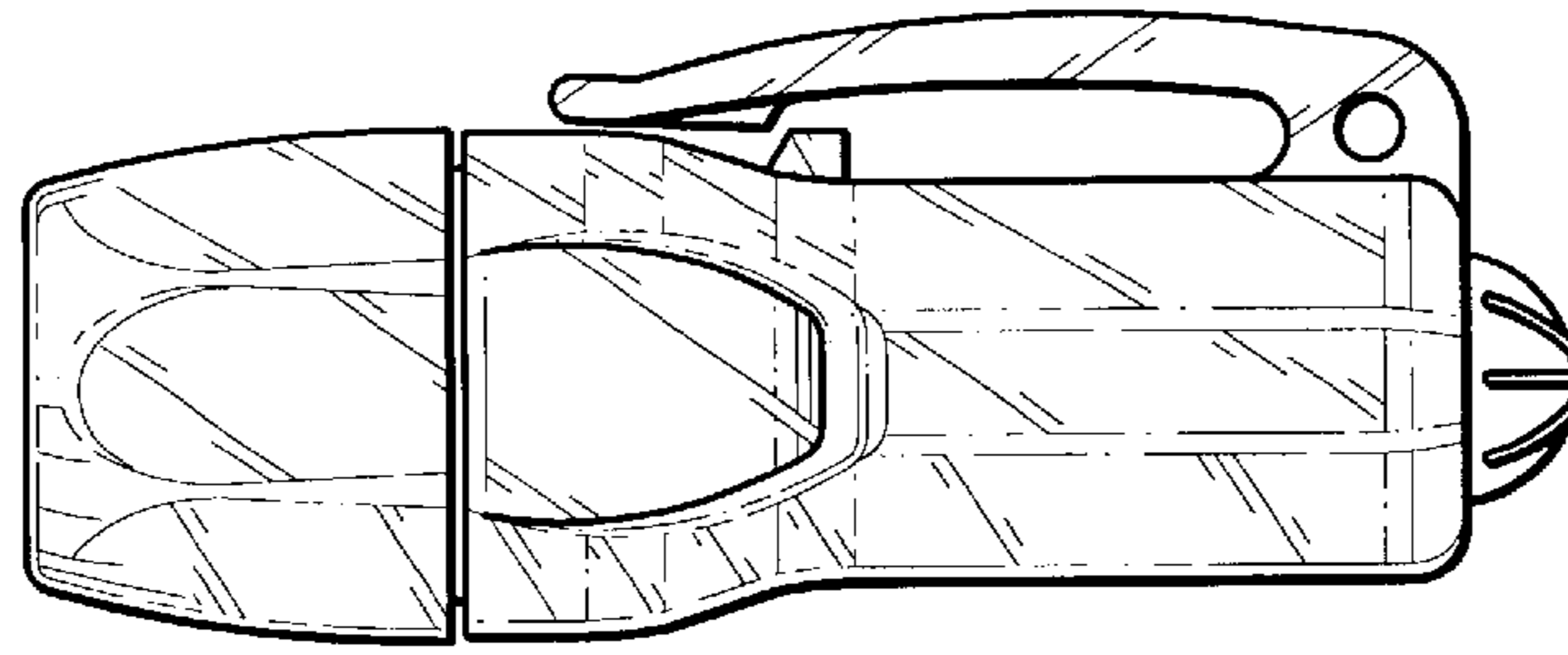

FIG. 8

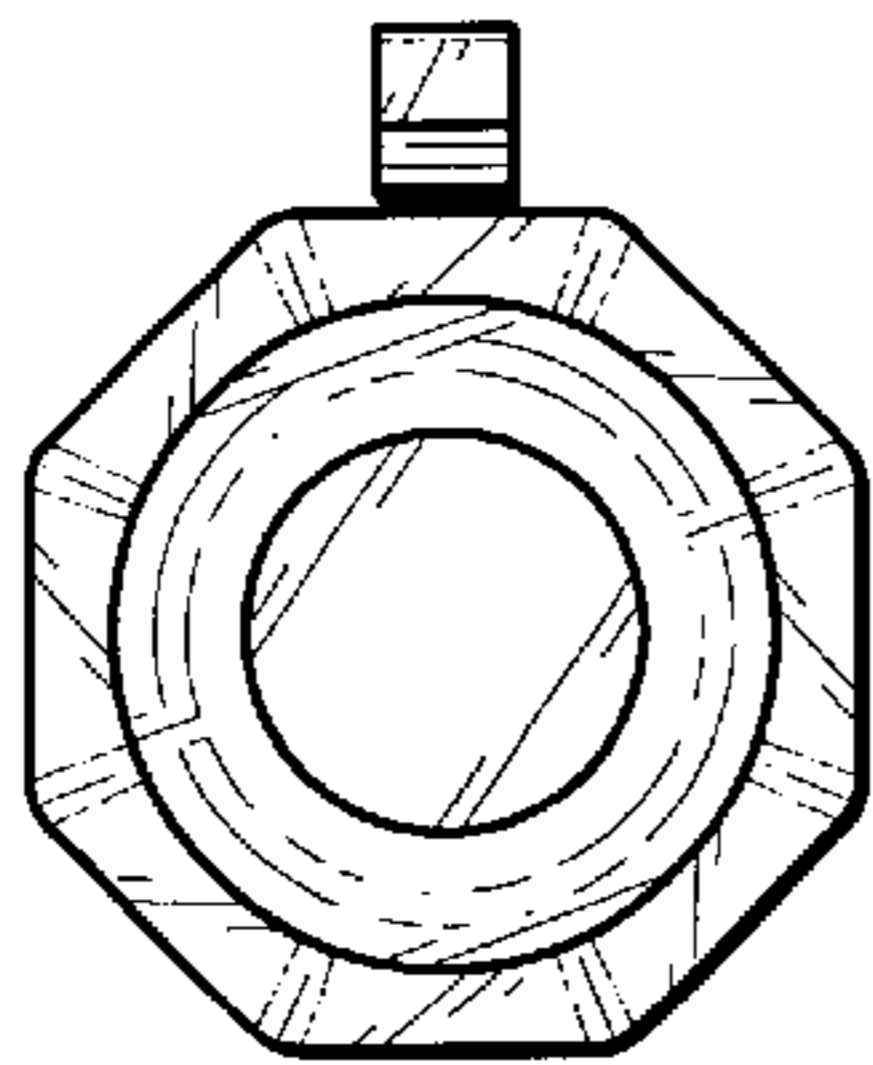

FIG. 9

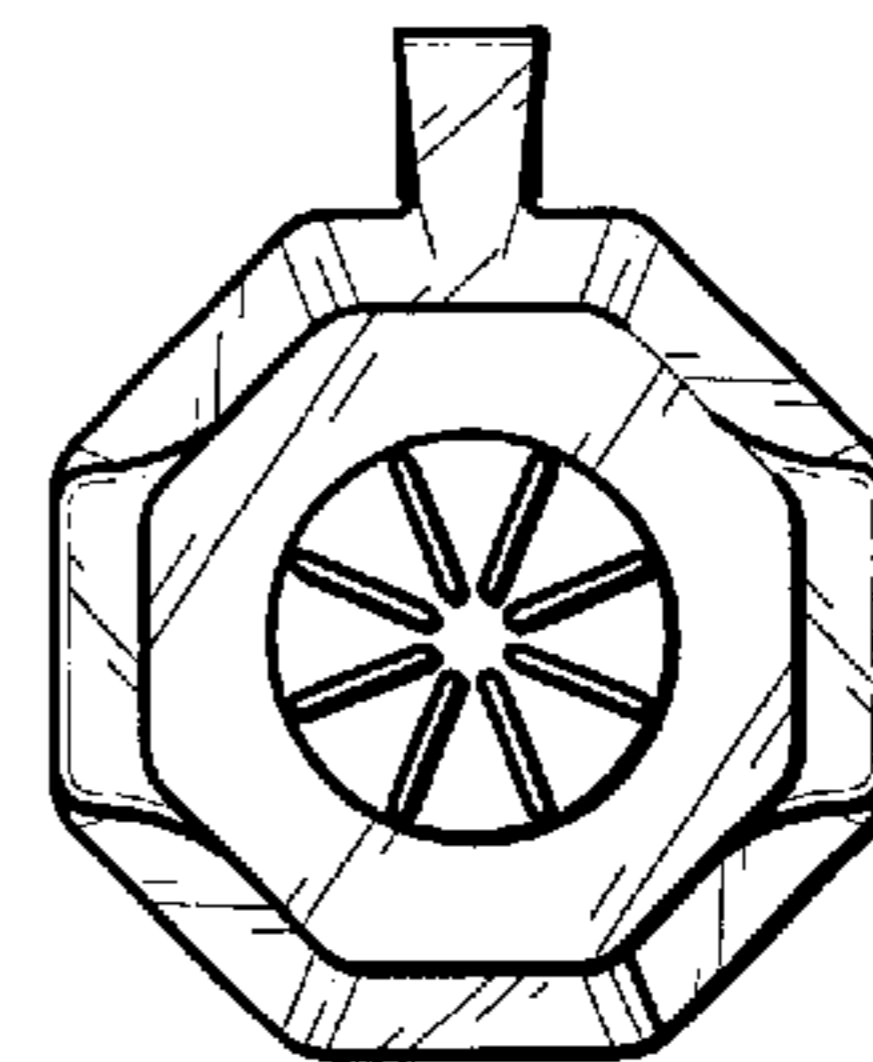

FIG. 10

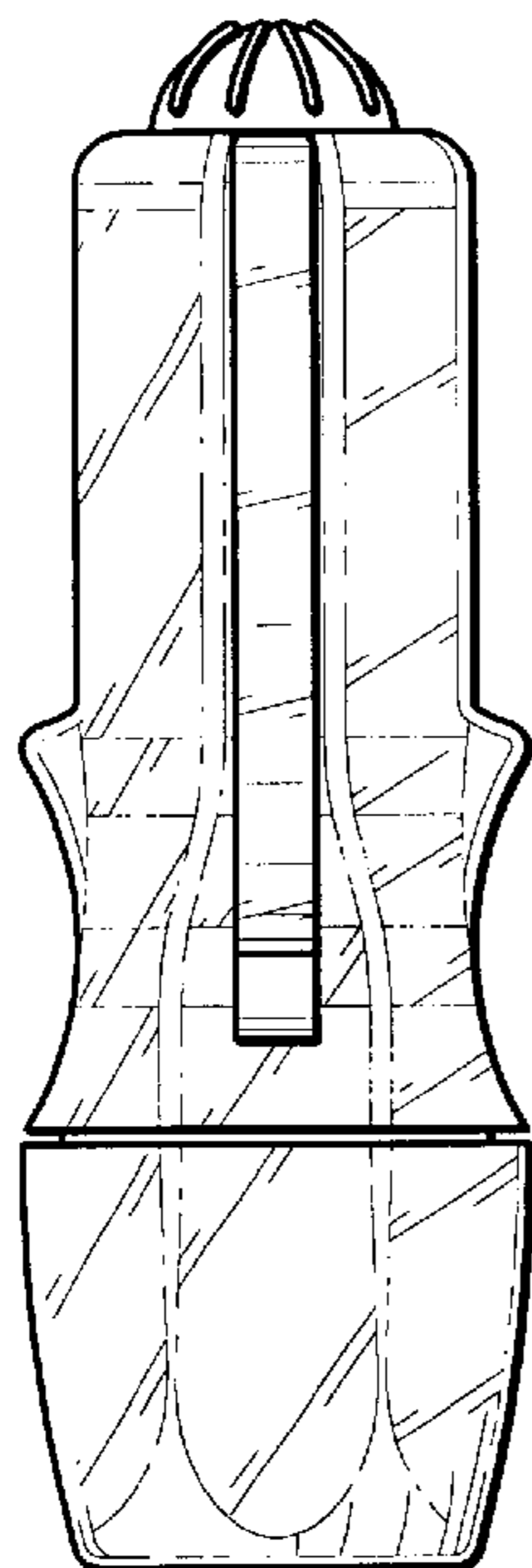

FIG. 11

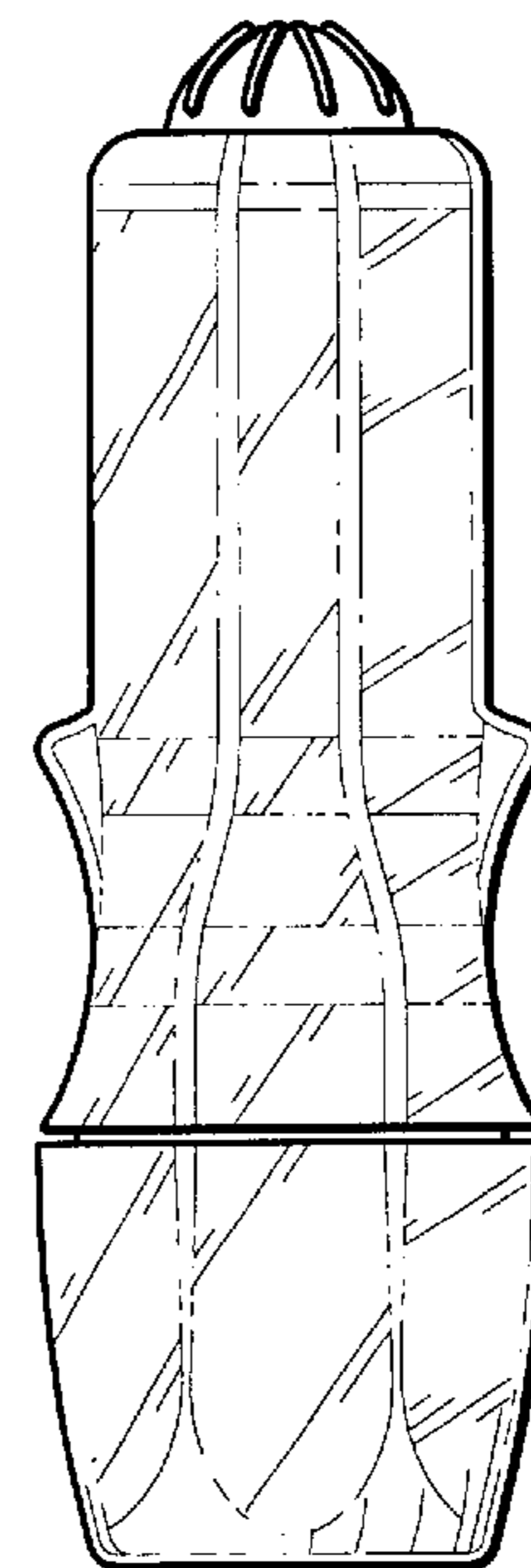

FIG. 12

FIG. 13

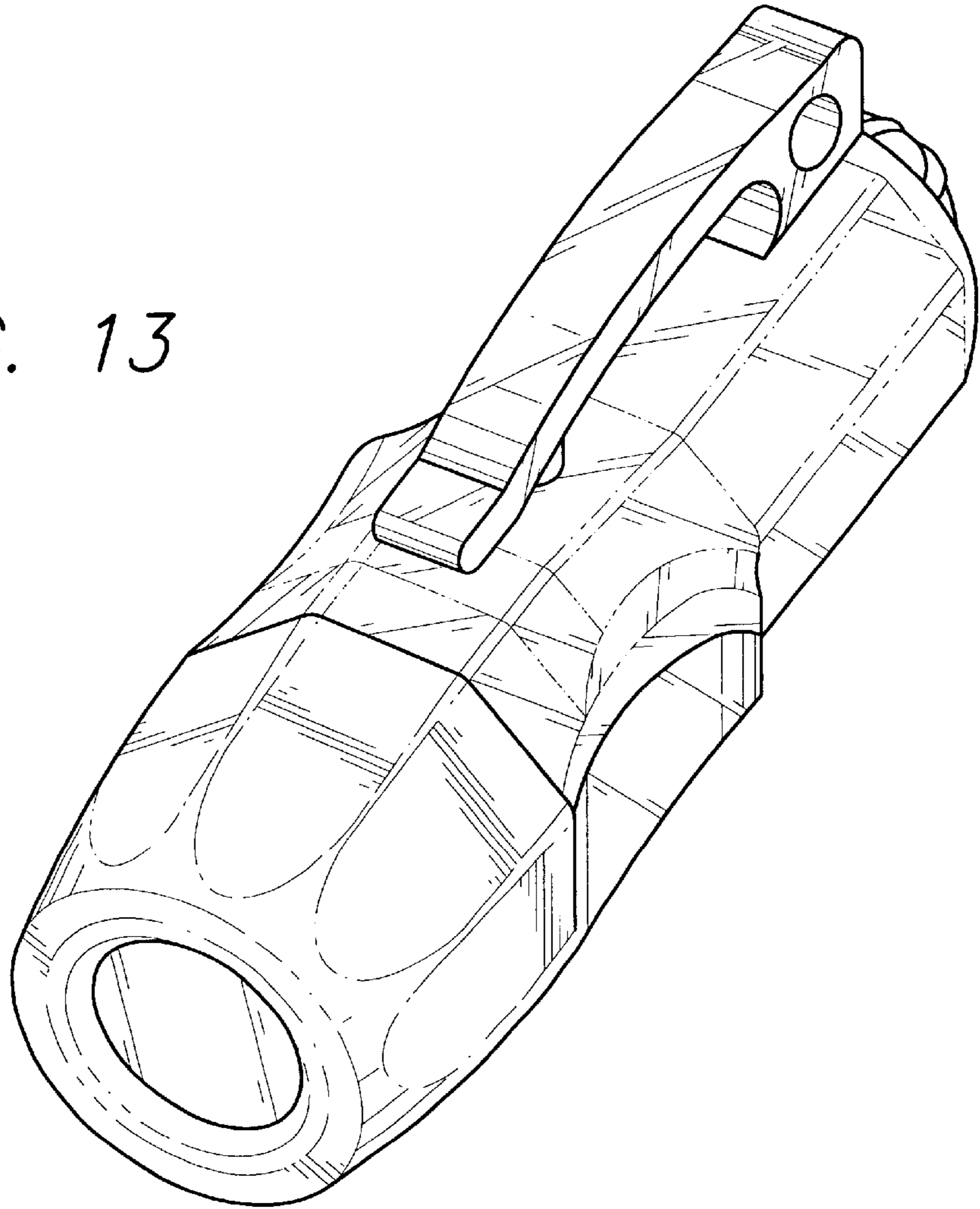

FIG. 14

