



US00D485471S

(12) **United States Design Patent**
Janky

(10) **Patent No.:** **US D485,471 S**
(45) **Date of Patent:** **** Jan. 20, 2004**

(54) **COFFEE TOOLS SET**

(75) Inventor: **Gregory T. Janky**, Sammamish, WA (US)

(73) Assignee: **Pacific Market, Inc.**, Seattle, WA (US)

(**) Term: **14 Years**

(21) Appl. No.: **29/182,478**

(22) Filed: **May 27, 2003**

(51) **LOC (7) Cl.** **07-01**

(52) **U.S. Cl.** **D7/505; D7/507; D7/300**

(58) **Field of Search** D21/483; 425/248; 220/504, 703, 592.16, 592.17, 630, 23.86; D7/523, 300, 500, 505, 507, 319, 509, 531, 691, 397, 506, 681, 413; D3/20, 239, 200, 205, 201, 202, 212, 226, 232, 903, 258, 276, 282; D10/57; 222/568, 285; 215/387

(56) **References Cited**

U.S. PATENT DOCUMENTS

D165,075 S * 11/1951 Hill D7/598

(List continued on next page.)

Primary Examiner—M. N. Pandozzi

(74) *Attorney, Agent, or Firm*—Seed IP Law Group PLLC

(57) **CLAIM**

The ornamental design for a coffee tools set, as shown and described.

DESCRIPTION

FIG. 1 is a front, left isometric perspective view of a coffee tools set showing my new design.

FIG. 2 is a front elevational view thereof.

FIG. 3 is a rear elevational view thereof.

FIG. 4 is a right side elevational view thereof.

FIG. 5 is a left side elevational view thereof.

FIG. 6 is a top plan view thereof.

FIG. 7 is a bottom plan view thereof.

FIG. 8 is a front, right isometric perspective view of a Frothing Pitcher of the coffee tools set showing my new design.

FIG. 9 is a front elevational view of the Frothing Pitcher of FIG. 8.

FIG. 10 is a rear elevational view of the Frothing Pitcher of FIG. 8.

FIG. 11 is a right side elevational view of the Frothing Pitcher of FIG. 8, the left side being a mirror image thereof.

FIG. 12 is a top plan view of the Frothing Pitcher of FIG. 8.

FIG. 13 is a bottom plan view of the Frothing Pitcher of FIG. 8.

FIG. 14 is a front, right isometric perspective view of a Shot Glass of the coffee tools set showing my new design.

FIG. 15 is a front elevational view of the Shot Glass of FIG. 14, the rear elevational view being a mirror image thereof.

FIG. 16 is a right side elevational view of the Shot Glass of FIG. 14, the left side being a mirror image thereof.

FIG. 17 is a top plan view of the Shot Glass of FIG. 14.

FIG. 18 is a bottom plan view of the Shot Glass of FIG. 14.

FIG. 19 is a front, right isometric perspective view of a Cocoa Shaker of the coffee tools set showing my new design.

FIG. 20 is a front elevational view of the Cocoa Shaker of FIG. 19, the rear elevational view being a mirror image thereof.

FIG. 21 is a right side elevational view of the Cocoa Shaker of FIG. 19, the left side being a mirror image thereof.

FIG. 22 is a top plan view of the Cocoa Shaker of FIG. 19.

FIG. 23 is a bottom plan view of the Cocoa Shaker of FIG. 19.

FIG. 24 is a front, right perspective view of a Scoop of the coffee tools set showing my new design.

FIG. 25 is a front elevational view of the Scoop of FIG. 24.

FIG. 26 is a rear elevational view of the Scoop of FIG. 24.

FIG. 27 is a right side elevational view of the Scoop of FIG. 24, the left side being a mirror image thereof.

FIG. 28 is a top plan view of the Scoop of FIG. 24.

FIG. 29 is a bottom plan view of the Scoop of FIG. 24.

FIG. 30 is a front, right isometric perspective view of a Thermometer of the coffee tools set showing my new design.

FIG. 31 is a front elevational view of the Thermometer of FIG. 30, the rear elevational view being a mirror image thereof.

FIG. 32 is a right side elevational view of the Thermometer of FIG. 30, the left side being a mirror image thereof.

FIG. 33 is a top plan view of the Thermometer of FIG. 30; and,

FIG. 34 is a bottom plan view of the Thermometer of FIG. 30.

The broken lines in the figures are for illustrative purposes only and form no part of the claimed design.

1 Claim, 8 Drawing Sheets

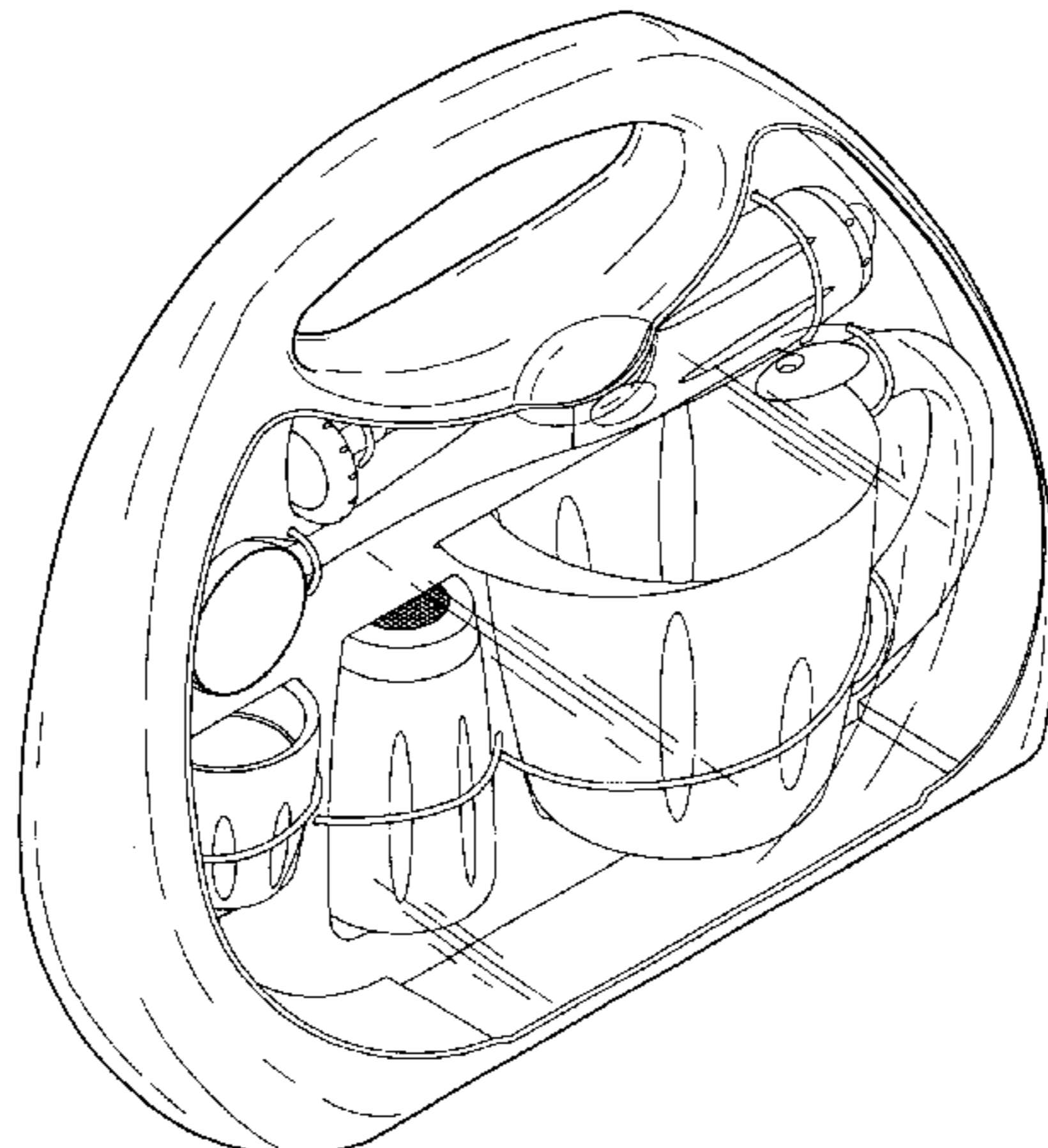

US D485,471 S

Page 2

U.S. PATENT DOCUMENTS

D193,128 S *	6/1962	Belokin	D3/258	D370,557 S *	6/1996	Ferris et al.	D3/205
3,632,015 A *	1/1972	Barth	220/630	D383,806 S *	9/1997	Yang	D21/483
3,964,629 A *	6/1976	McCabe	220/23.86	D390,416 S *	2/1998	Hippen et al.	D7/413
D312,193 S *	11/1990	Cooper	D7/681	D393,777 S *	4/1998	Bernard	D7/505
D333,912 S *	3/1993	Cheng	D3/282	D435,964 S *	1/2001	Lentz	D3/239
D362,546 S *	9/1995	Mundorf et al.	D3/276	D453,089 S *	1/2002	Neidigh	D7/319
5,487,486 A *	1/1996	Meneo	220/504	D468,966 S *	1/2003	Shareef	D7/506

* cited by examiner

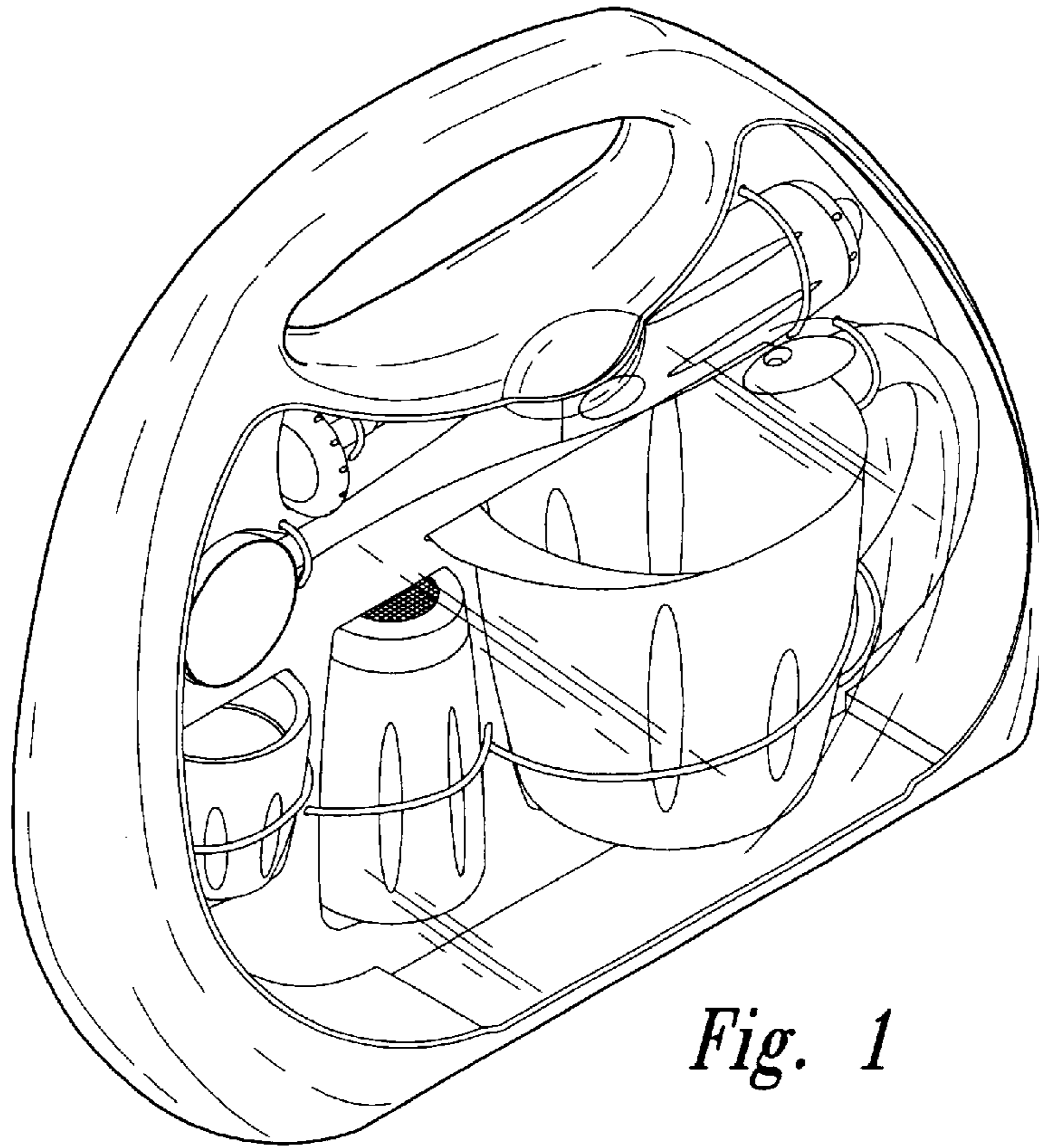

Fig. 1

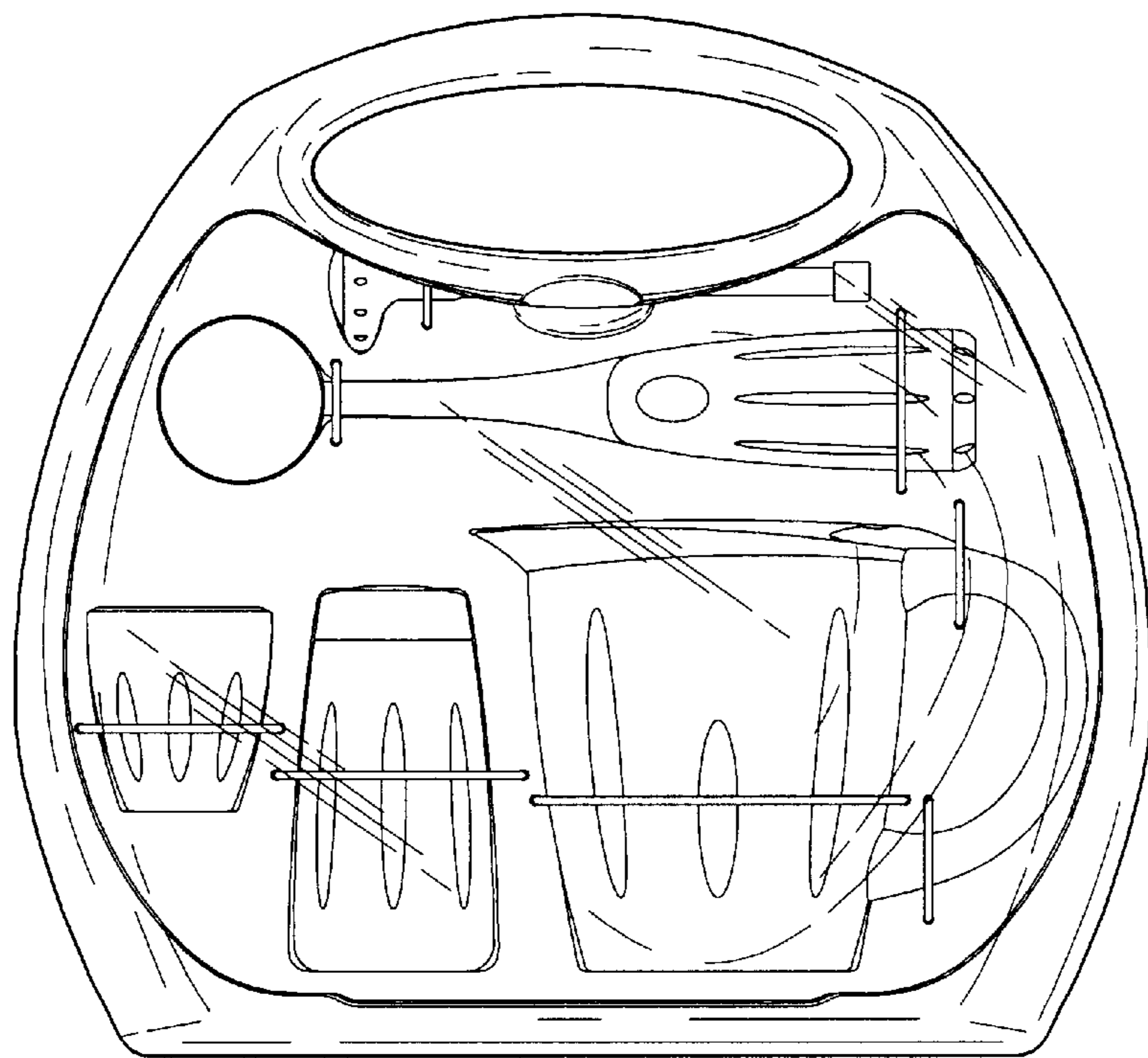

Fig. 2

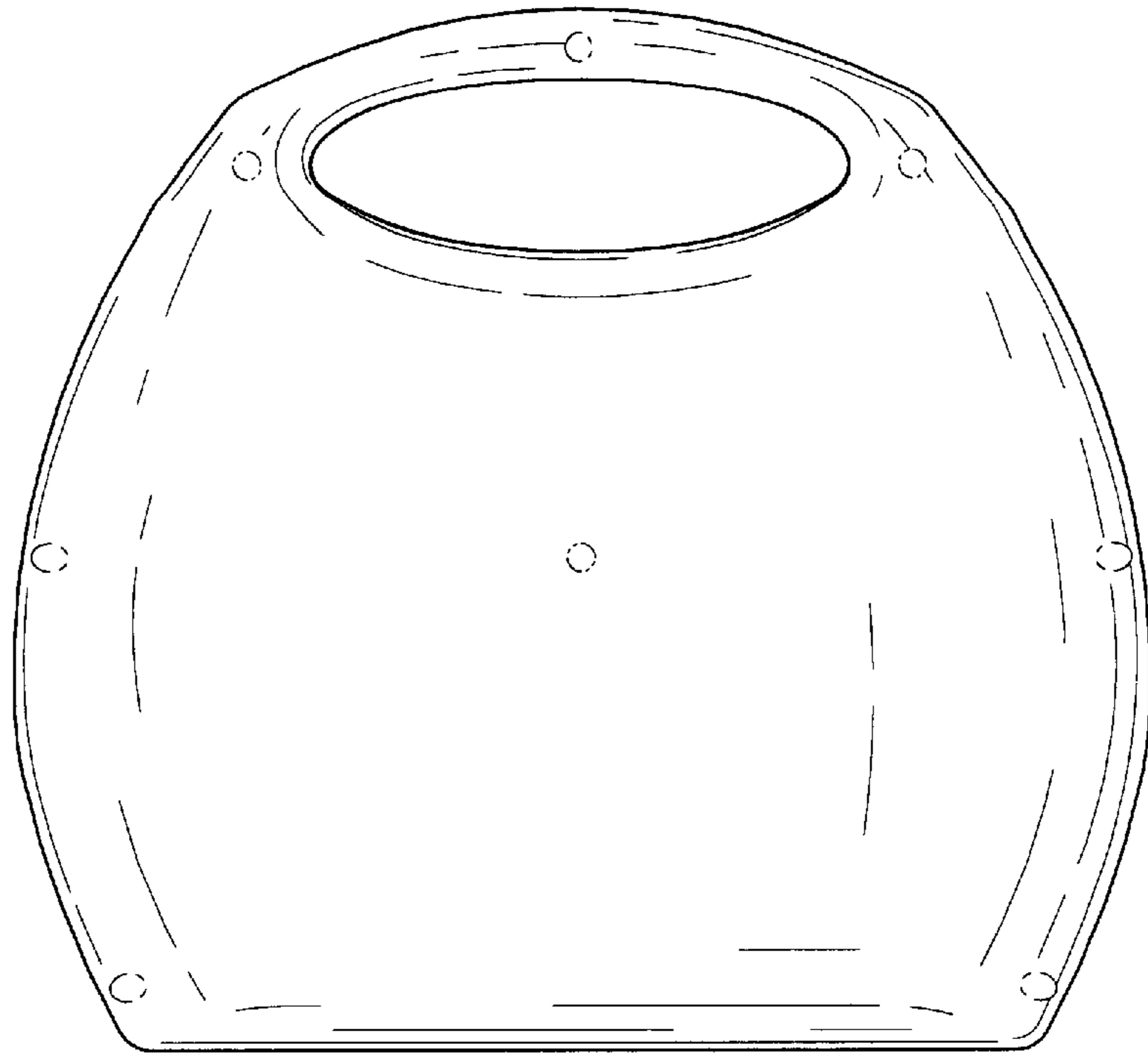

Fig. 3

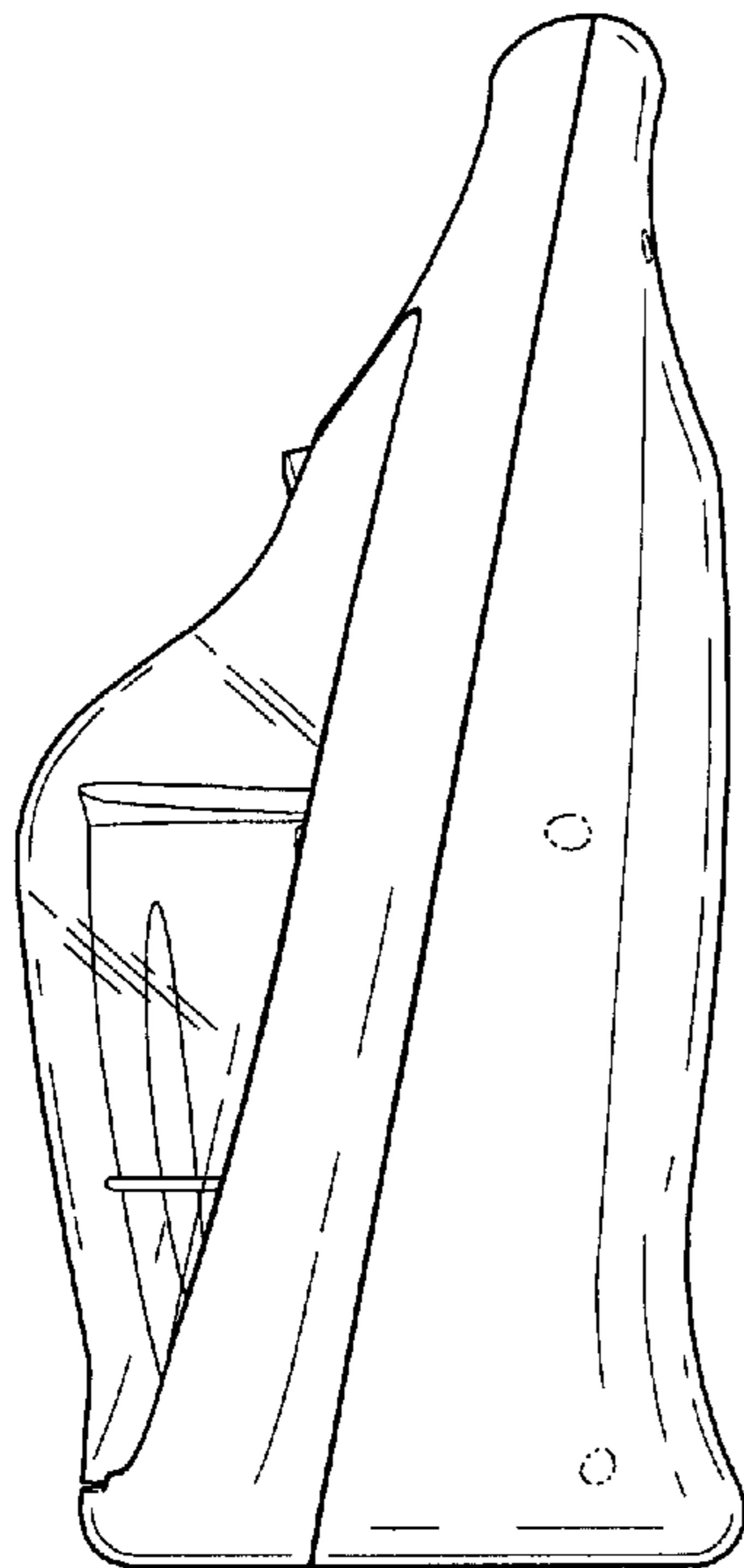

Fig. 4

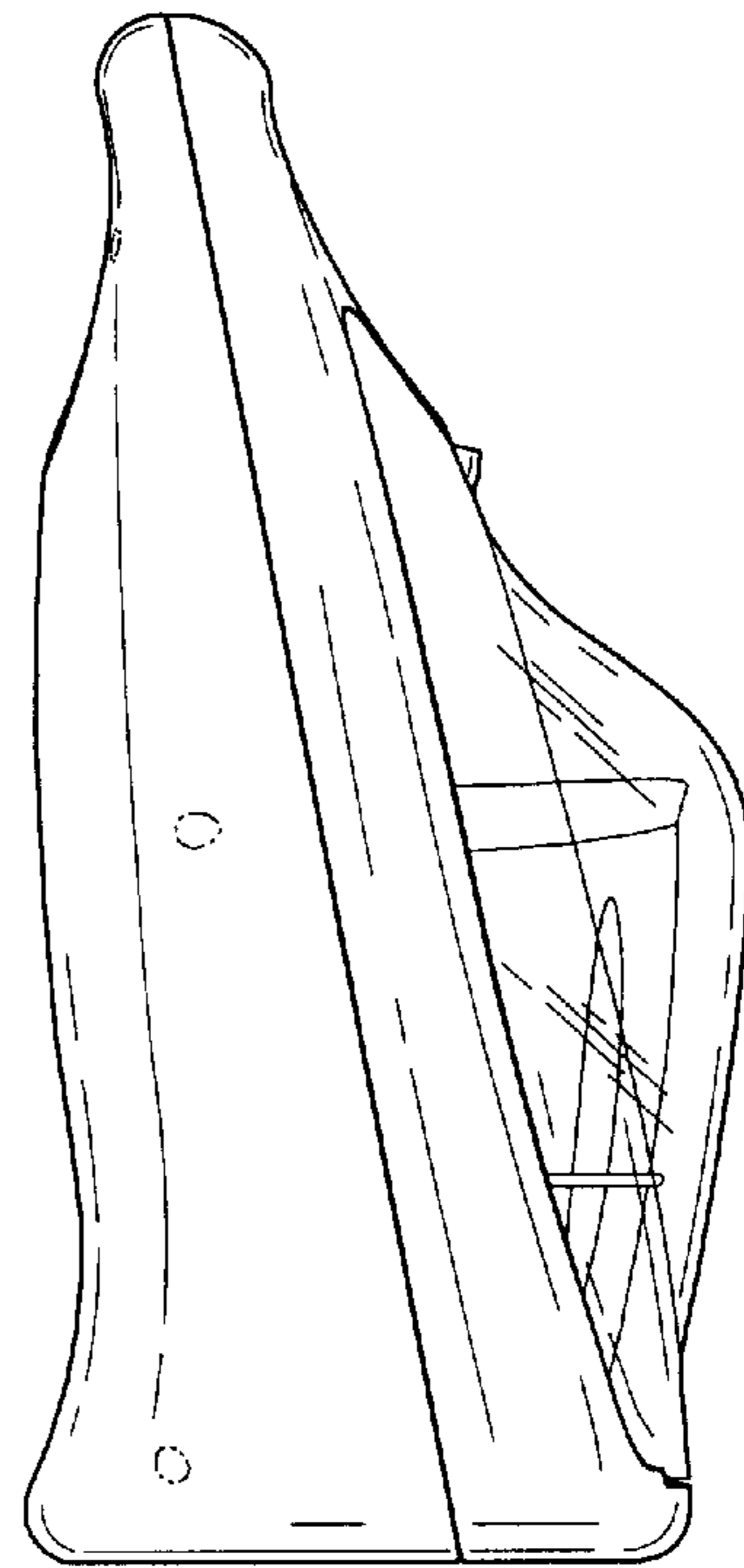

Fig. 5

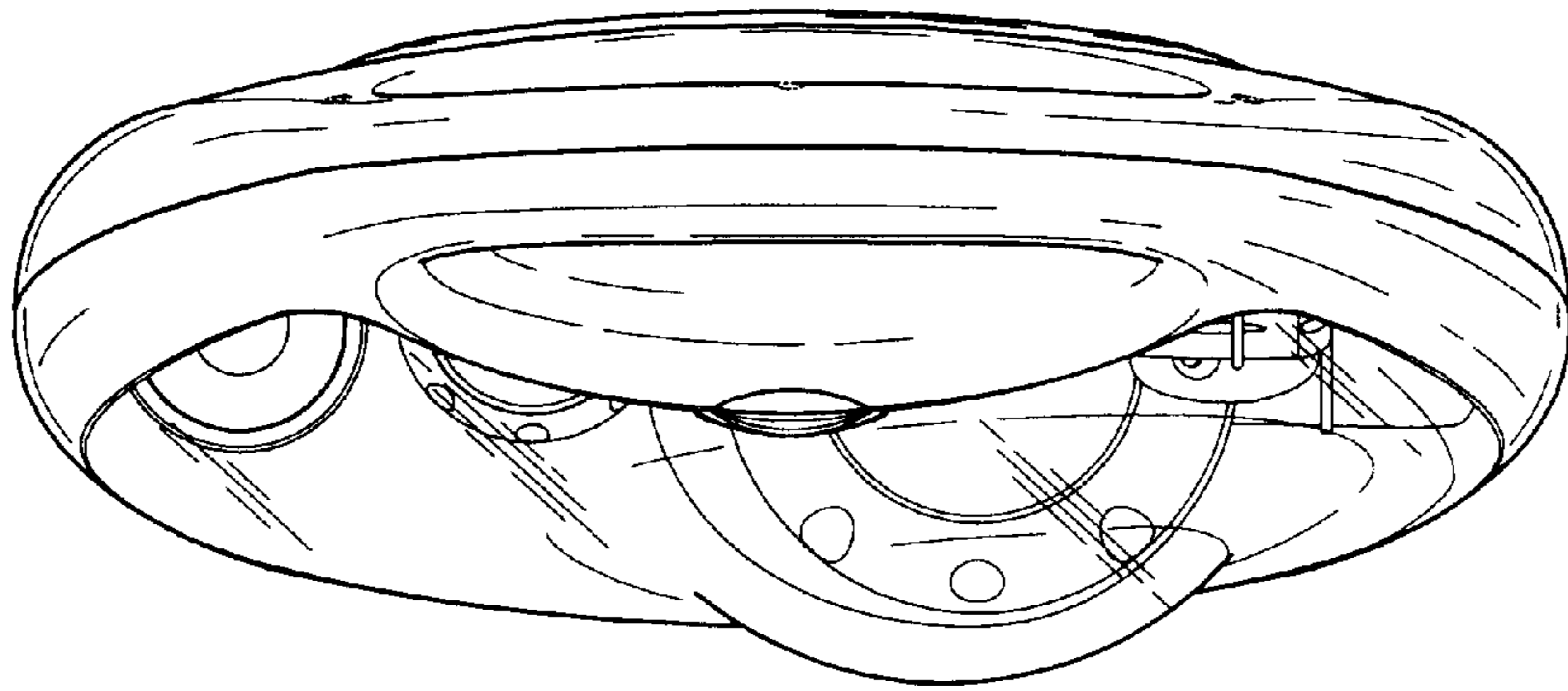

Fig. 6

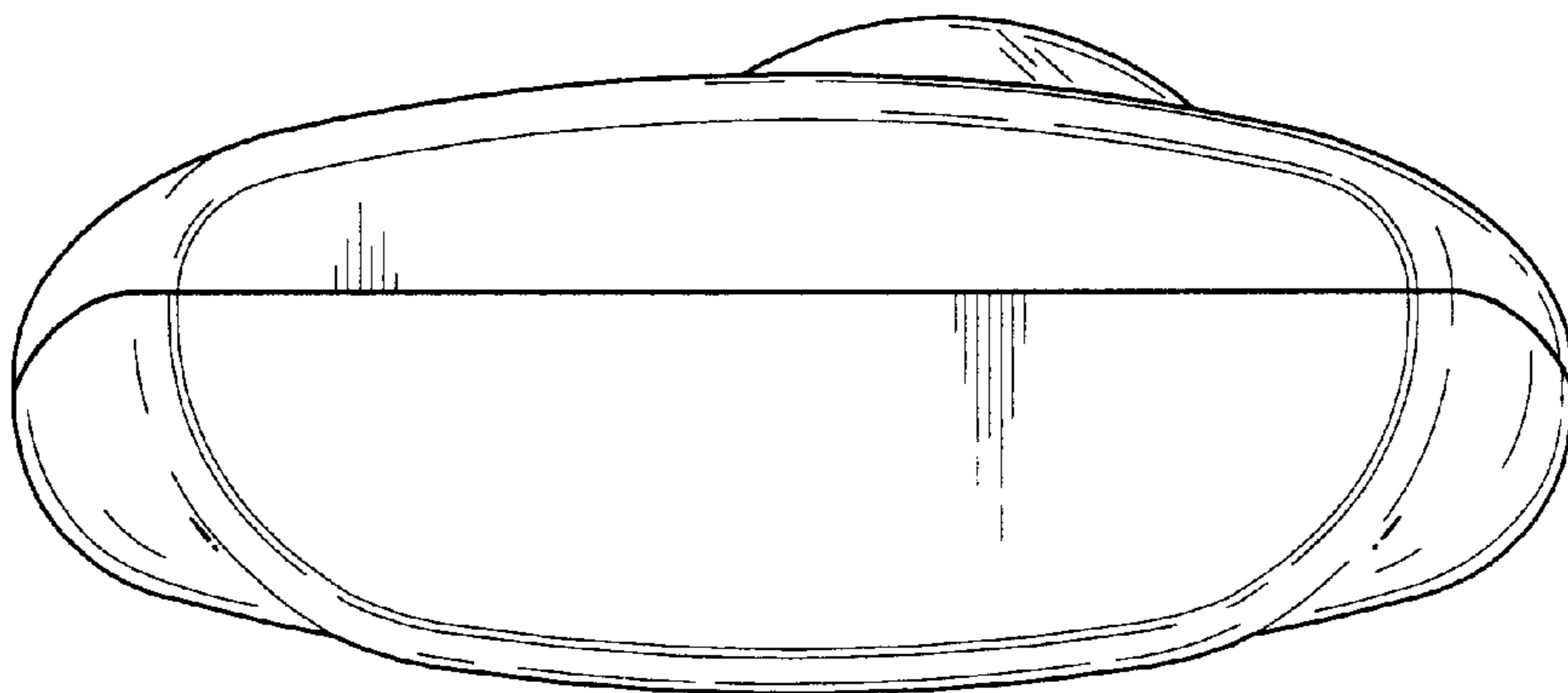

Fig. 7

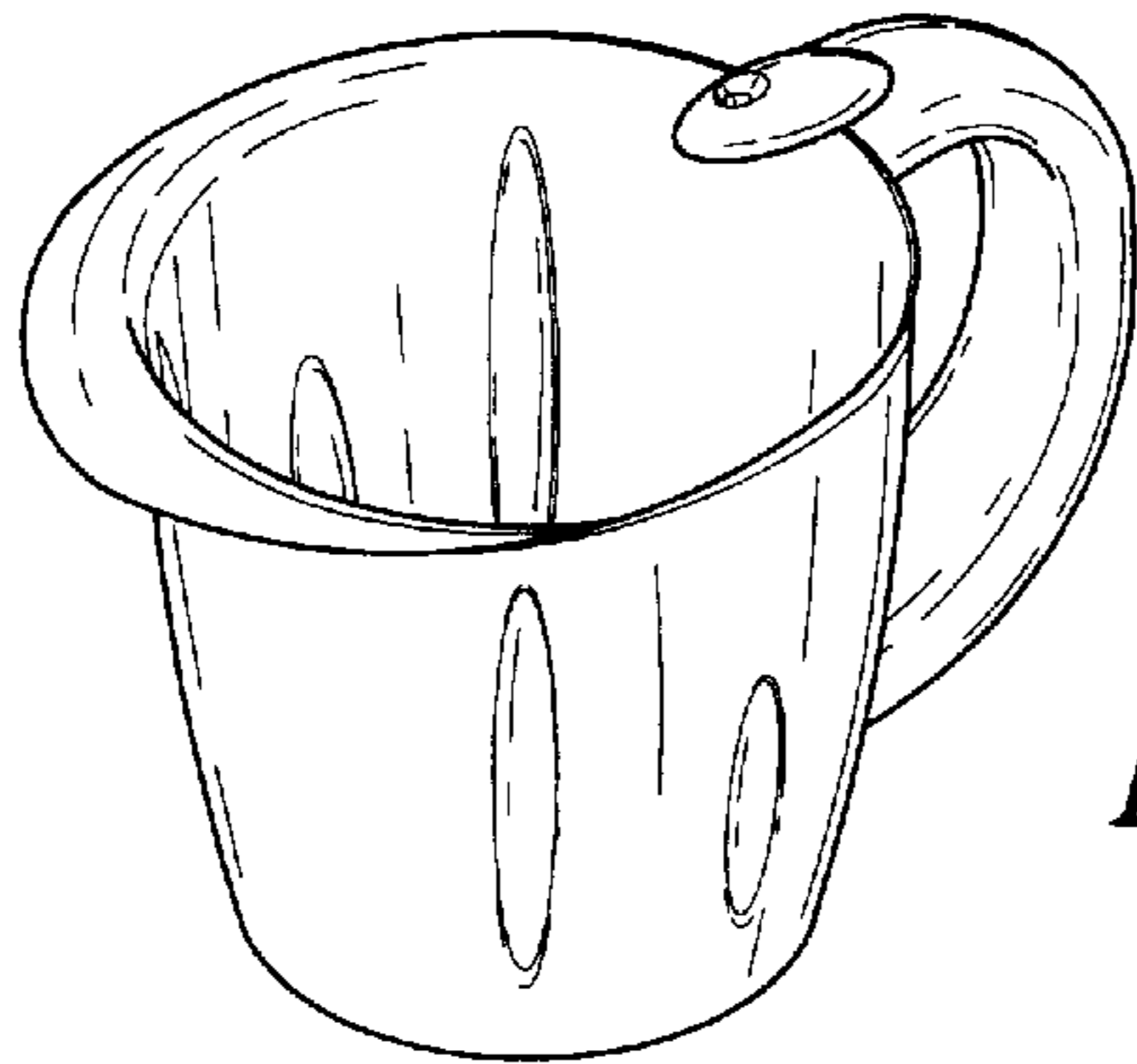

Fig. 8

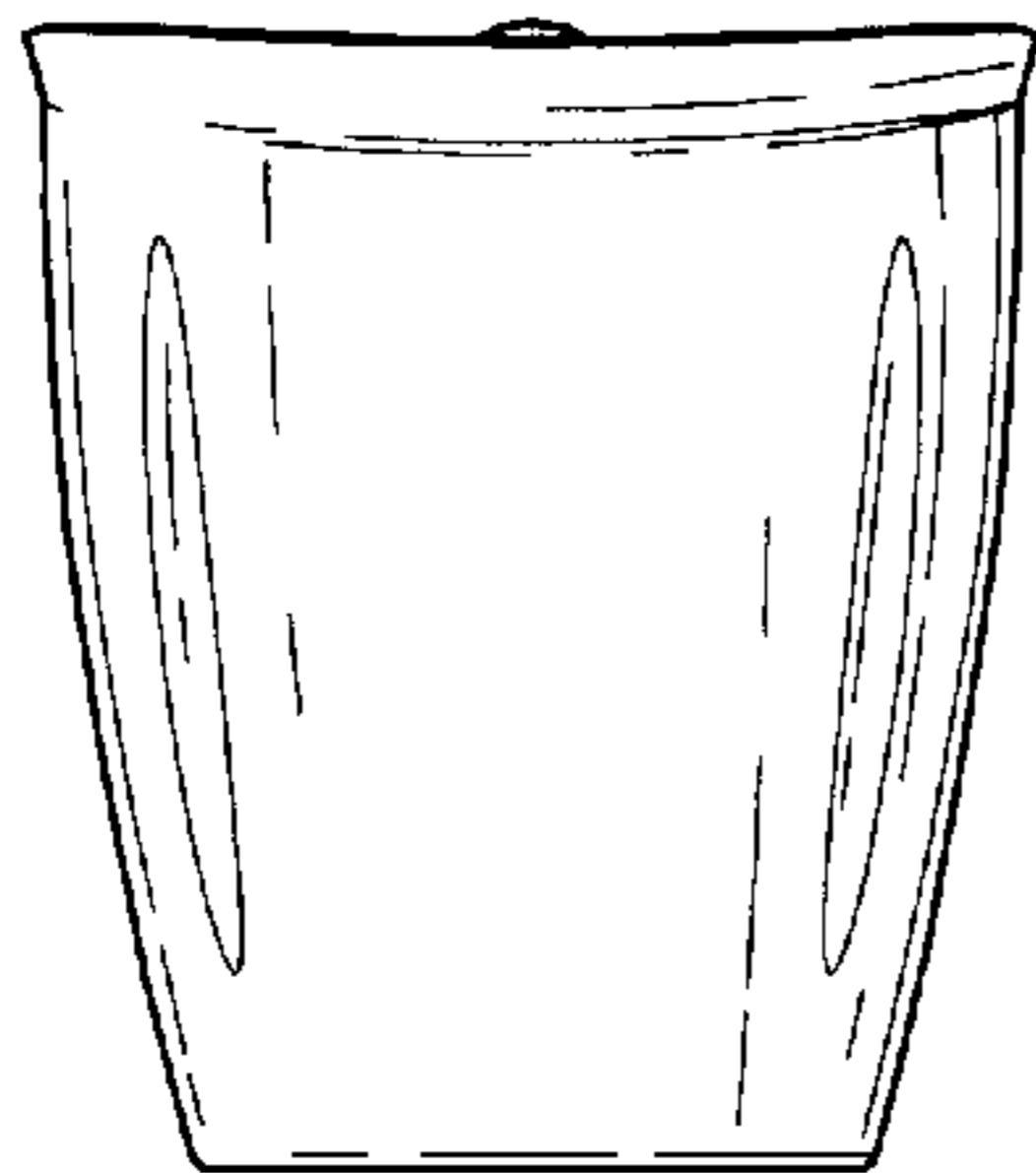

Fig. 9

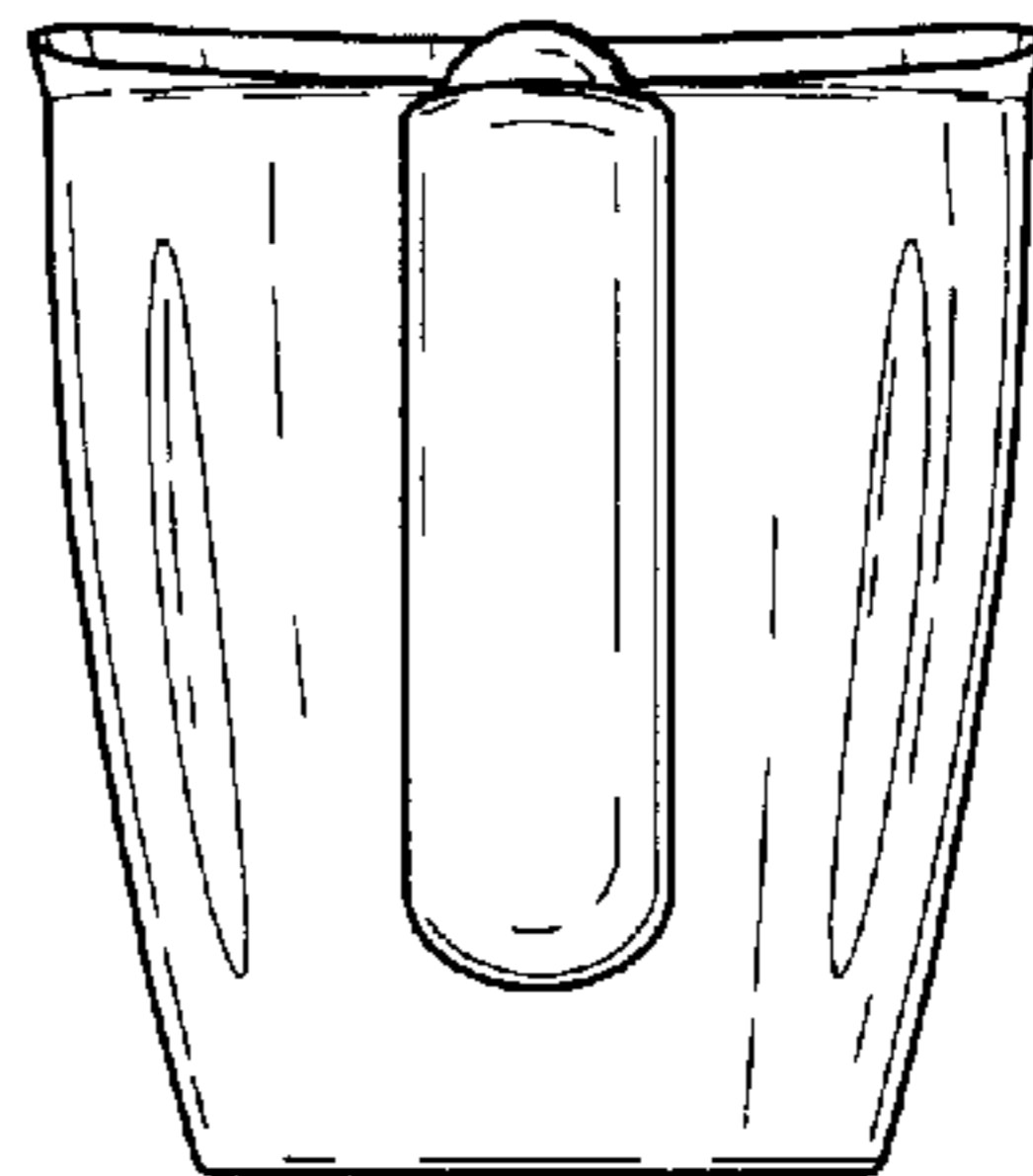

Fig. 10

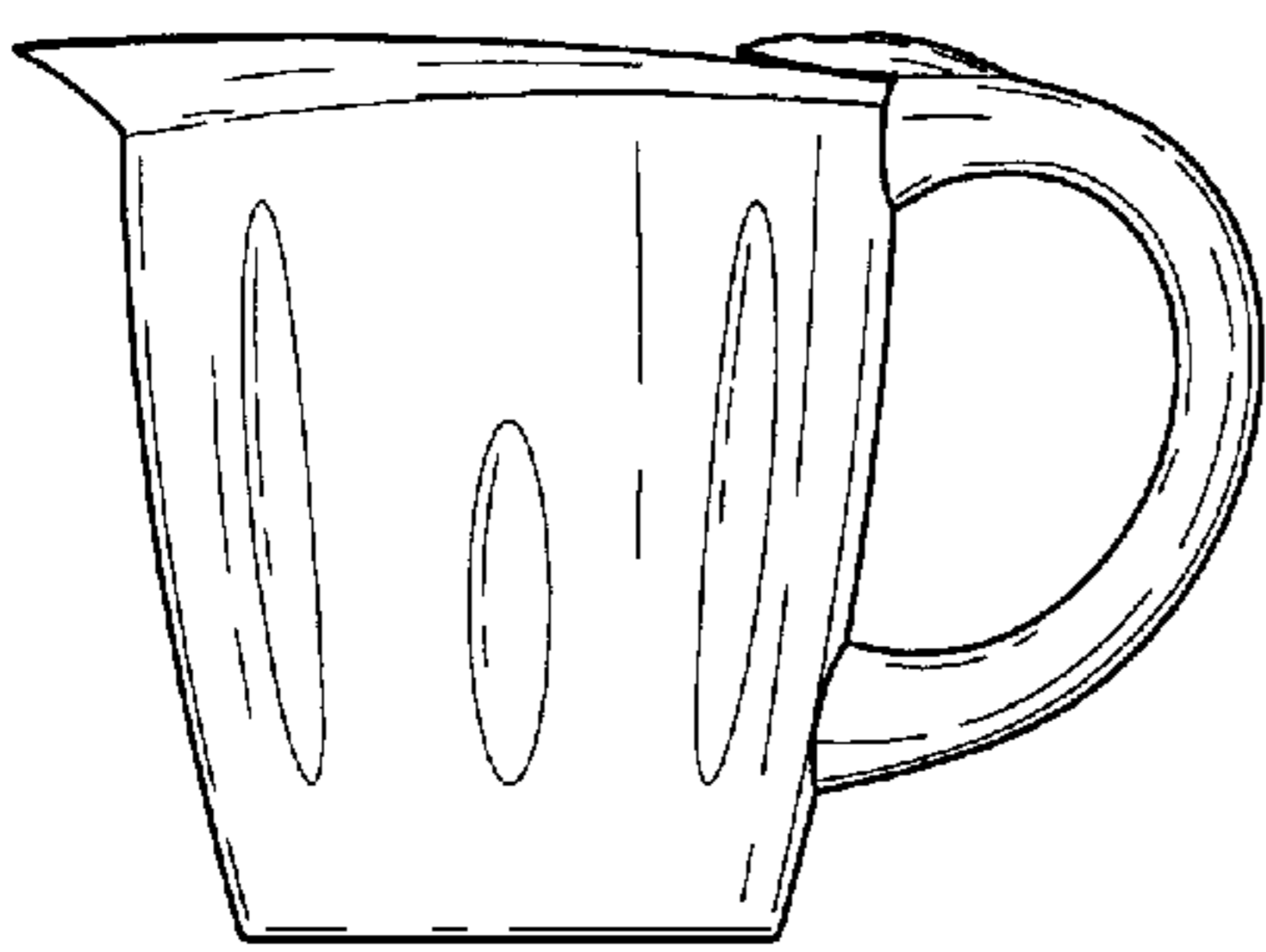

Fig. 11

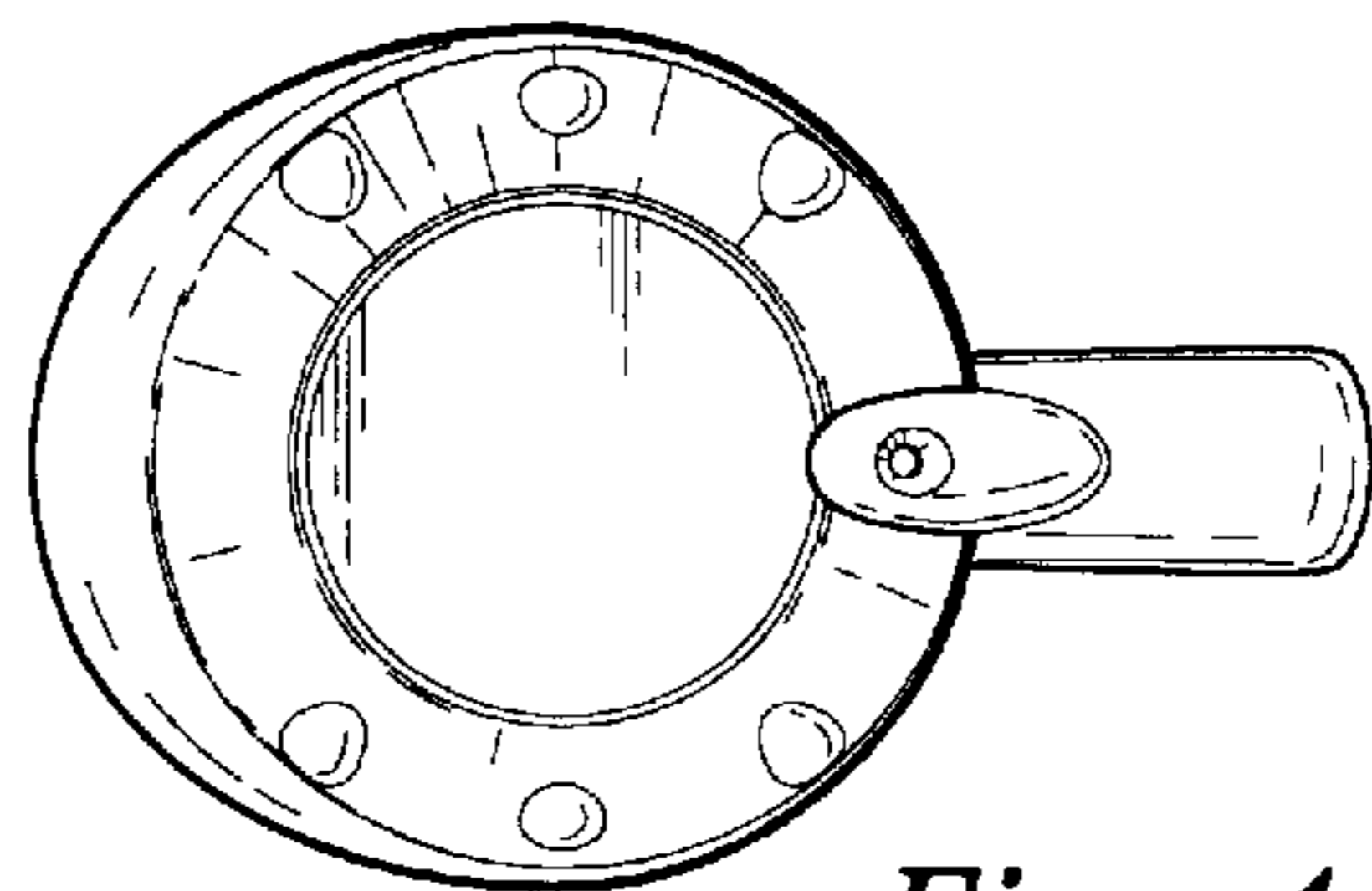

Fig. 12

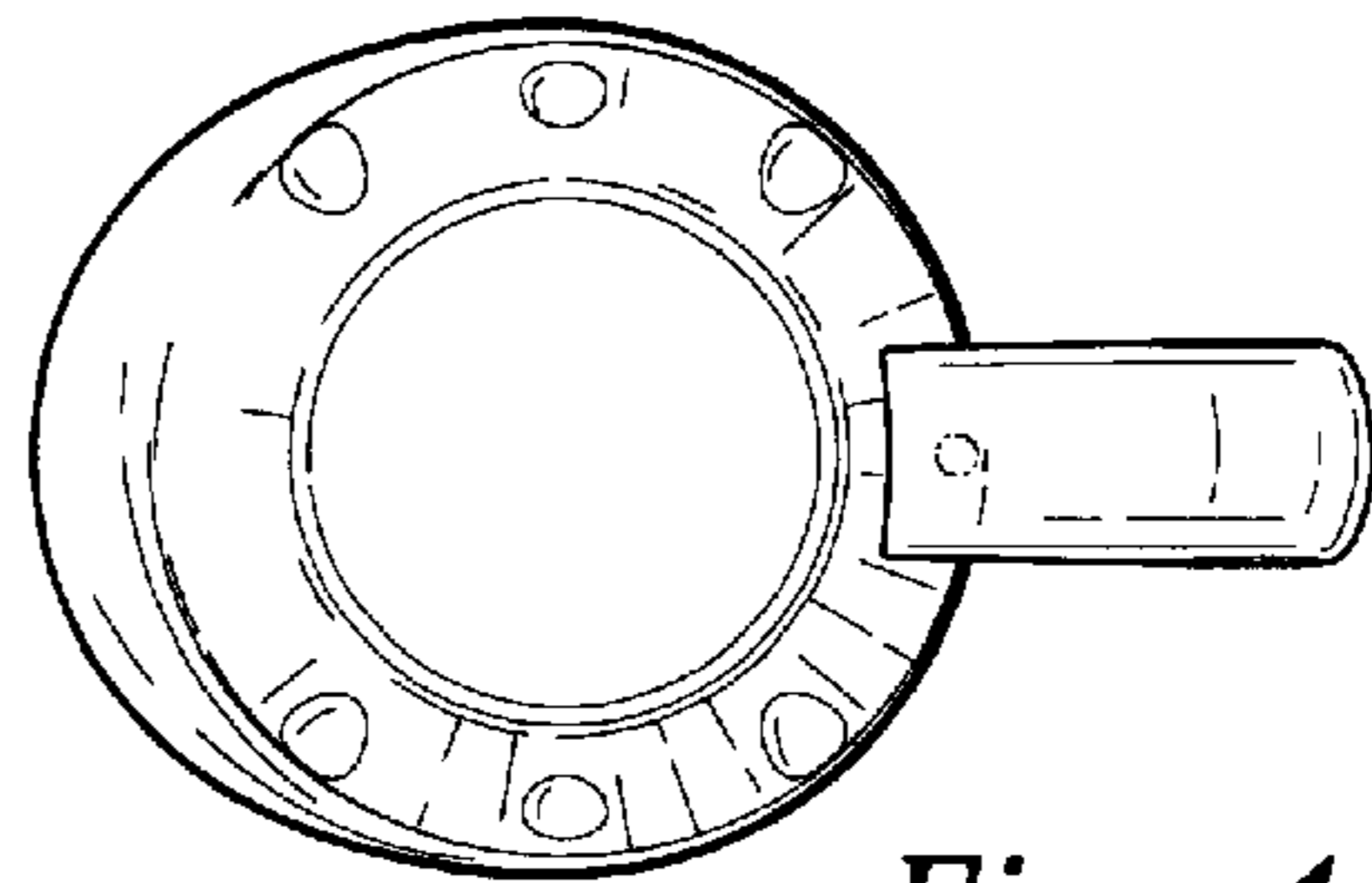

Fig. 13

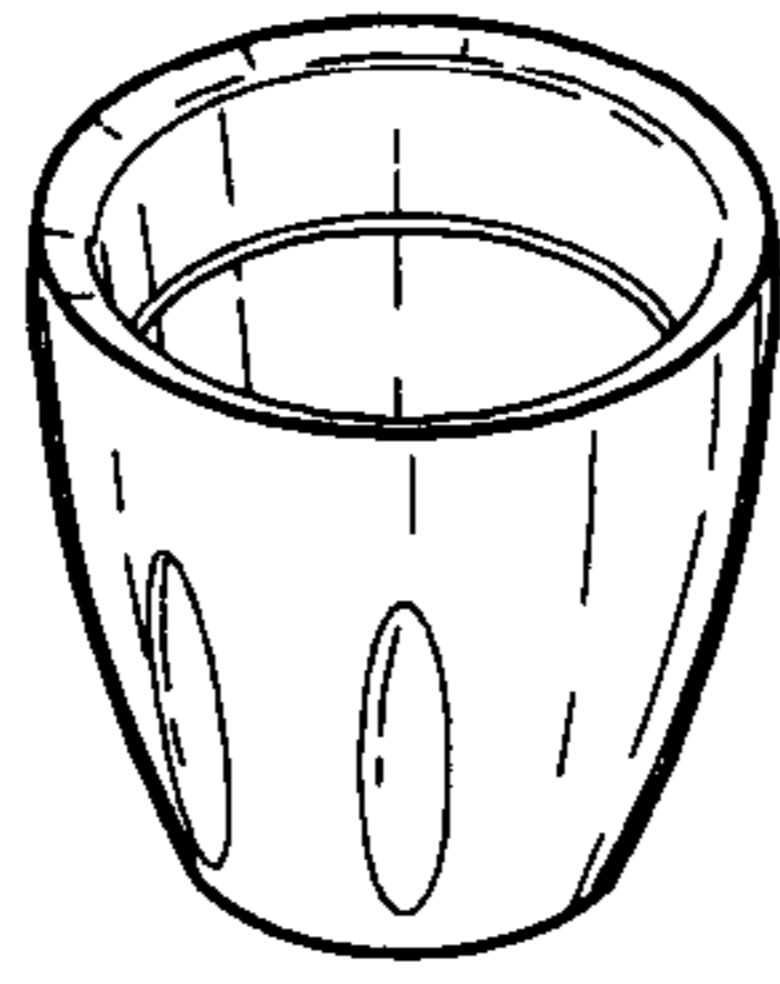

Fig. 14

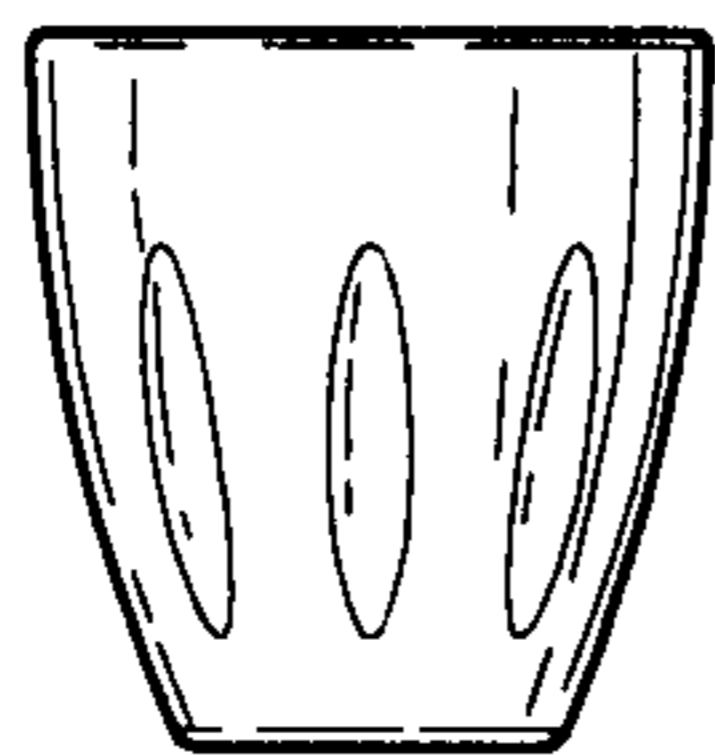

Fig. 15

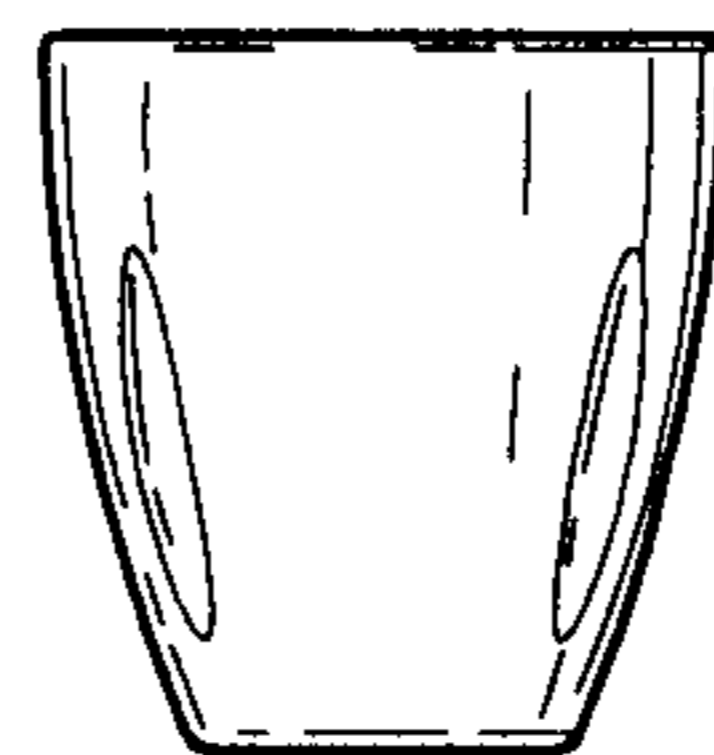

Fig. 16

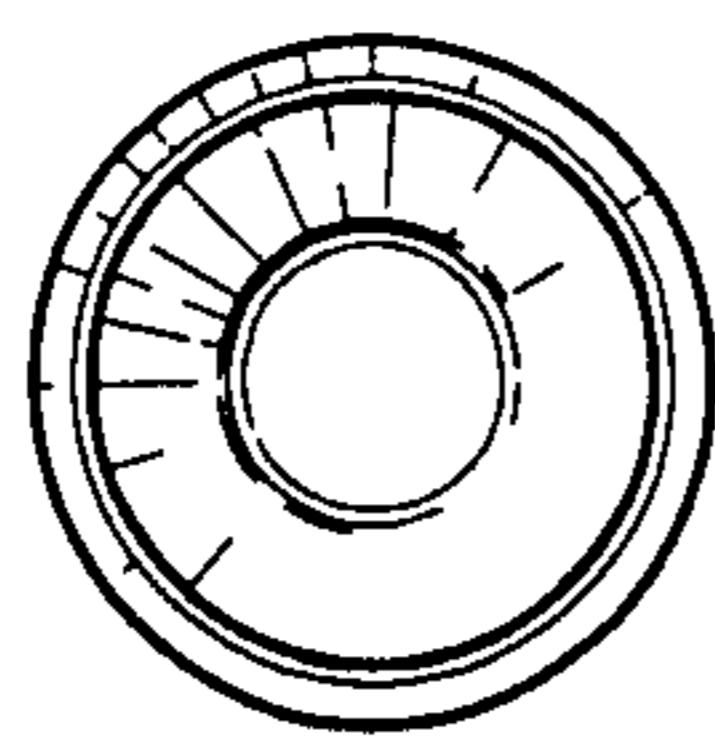

Fig. 17

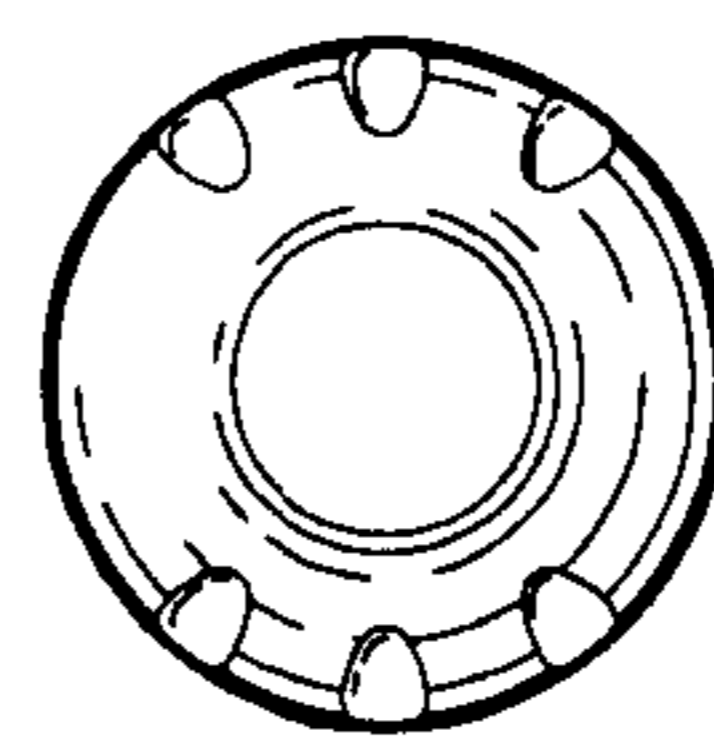

Fig. 18

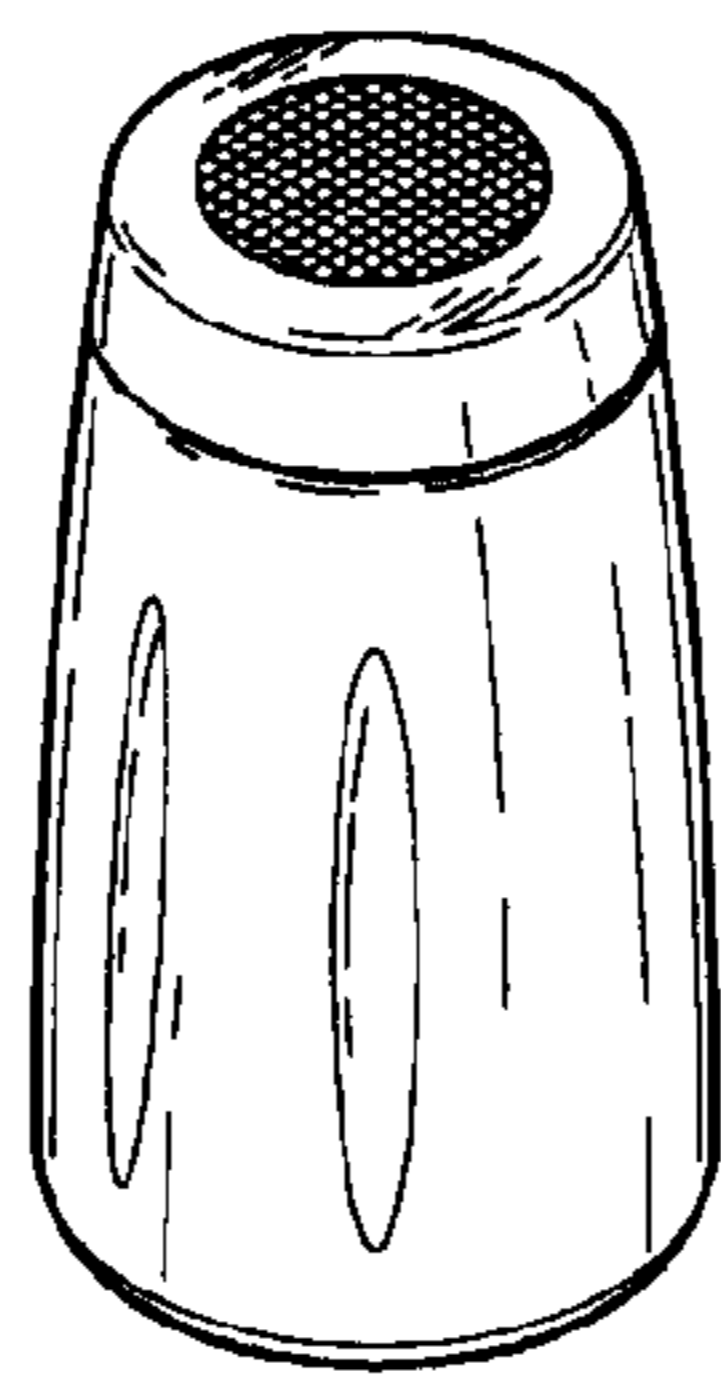

Fig. 19

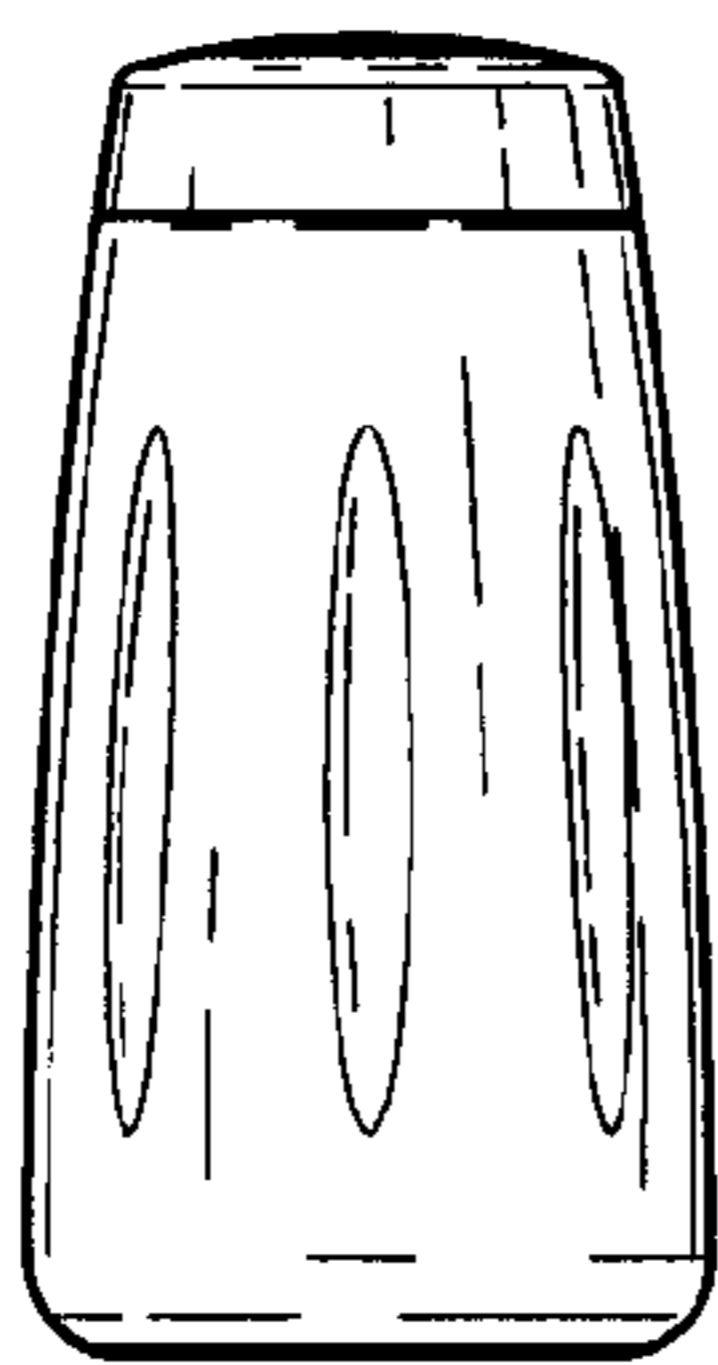

Fig. 20



Fig. 21

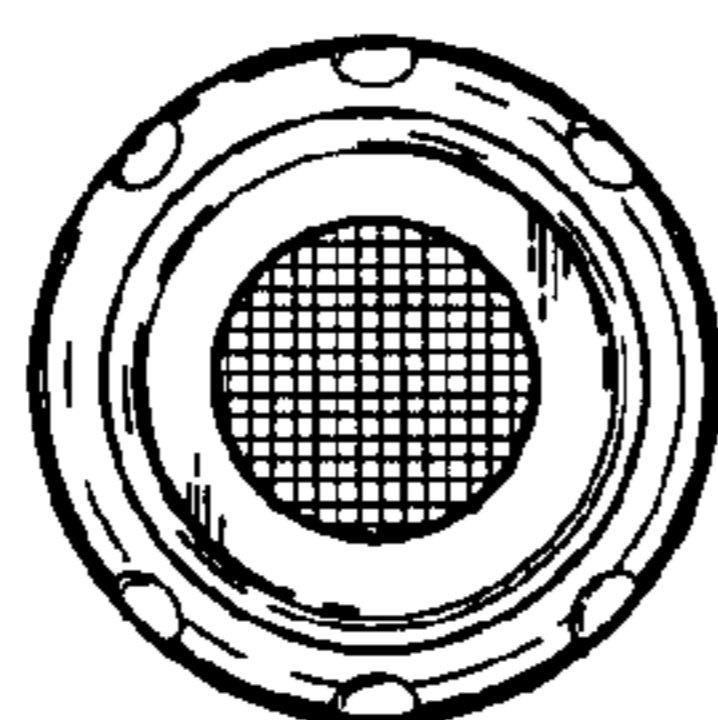

Fig. 22

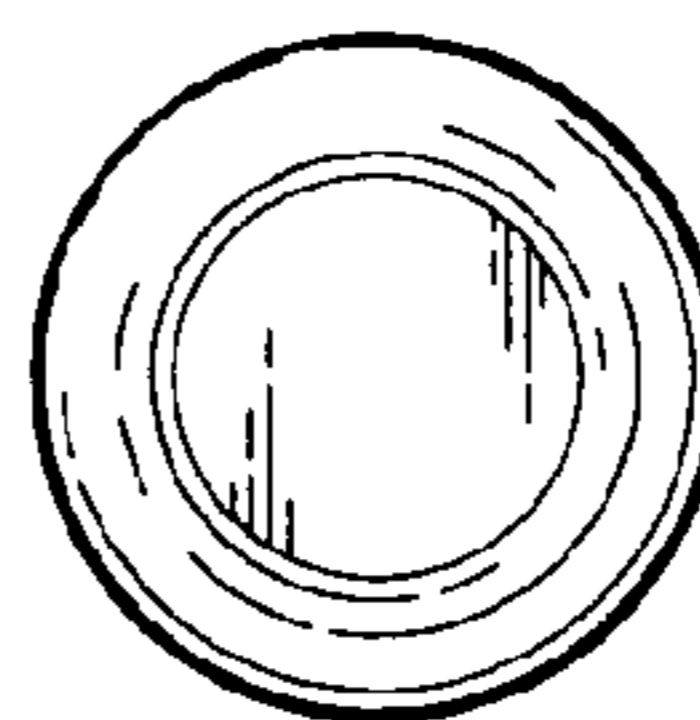

Fig. 23

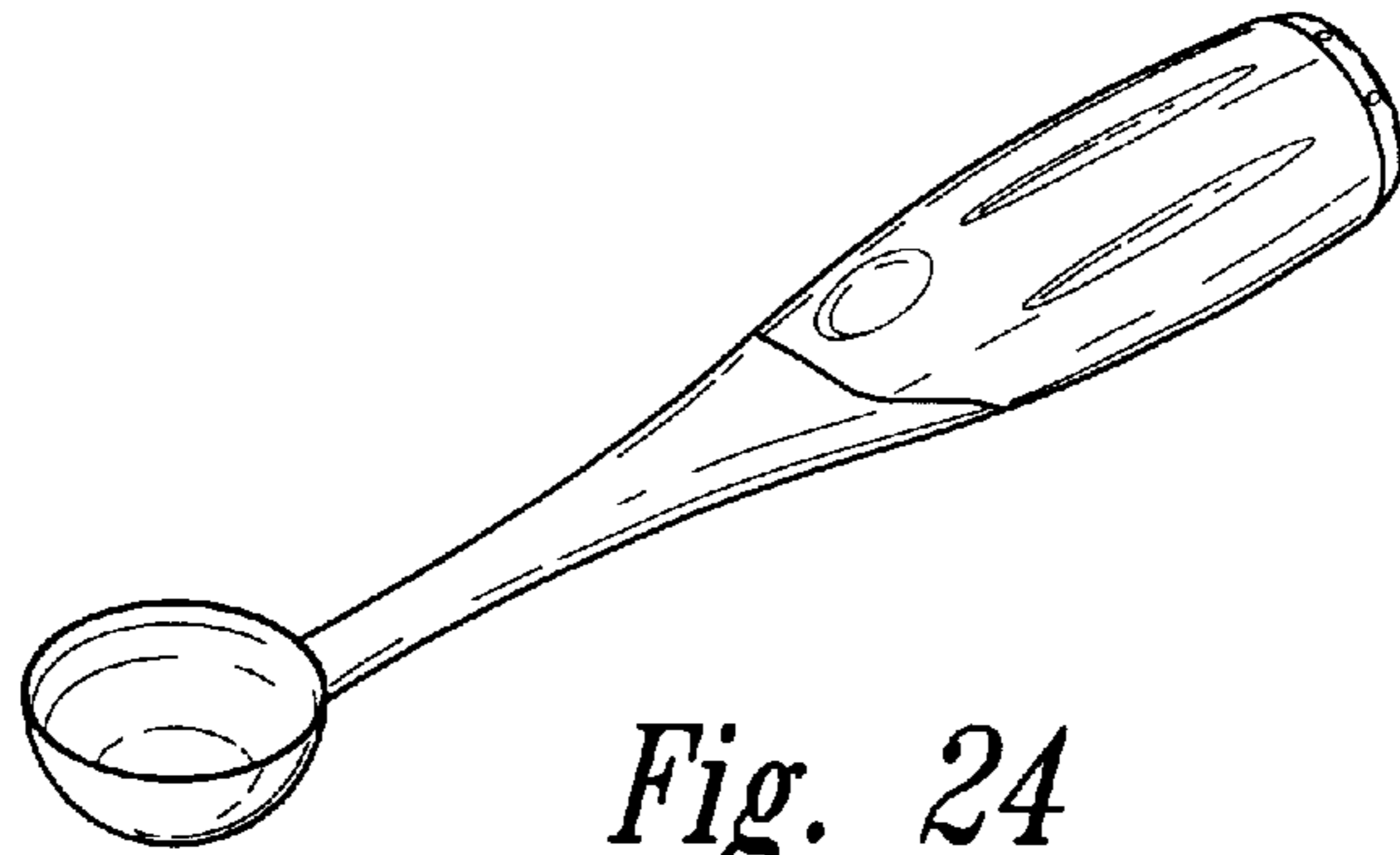

Fig. 24



Fig. 25

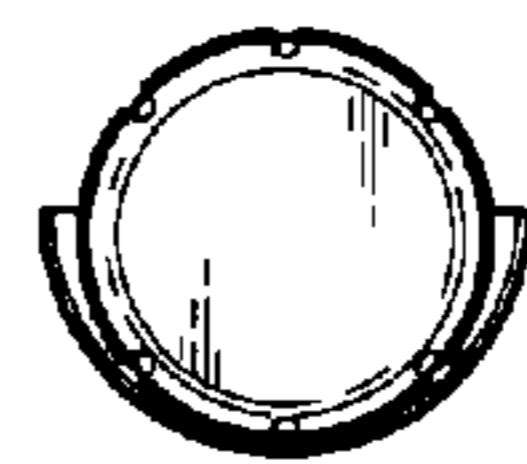

Fig. 26

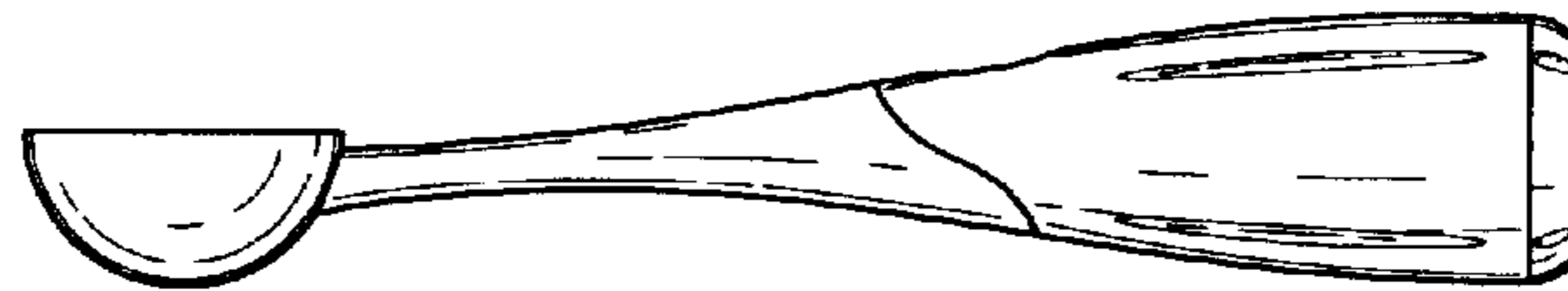

Fig. 27

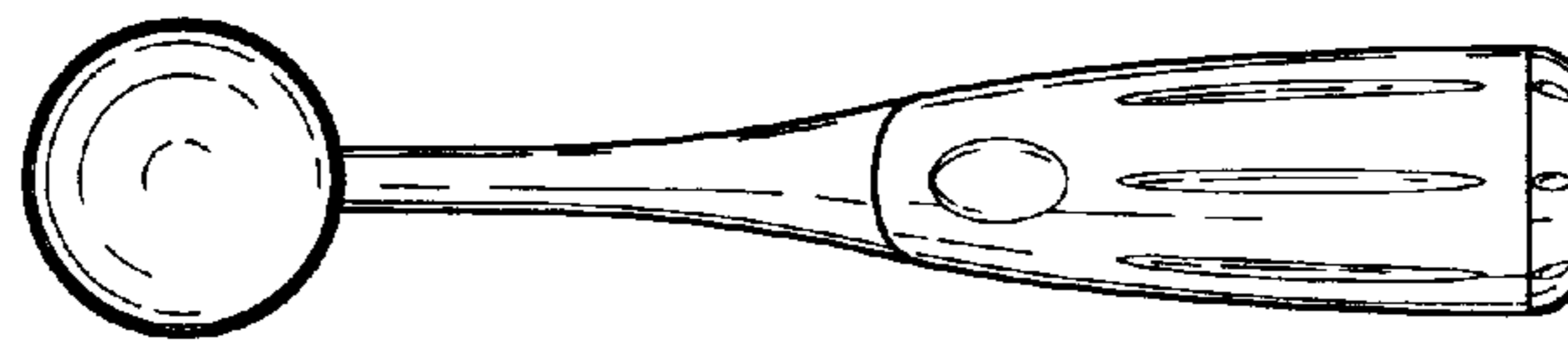

Fig. 28



Fig. 29

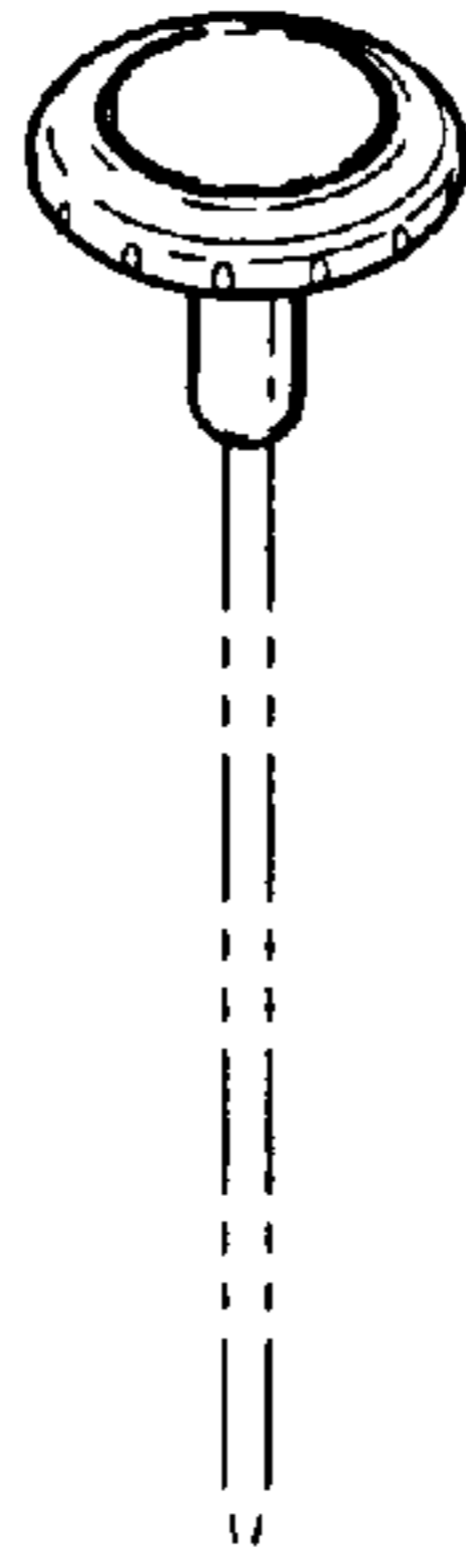

Fig. 30

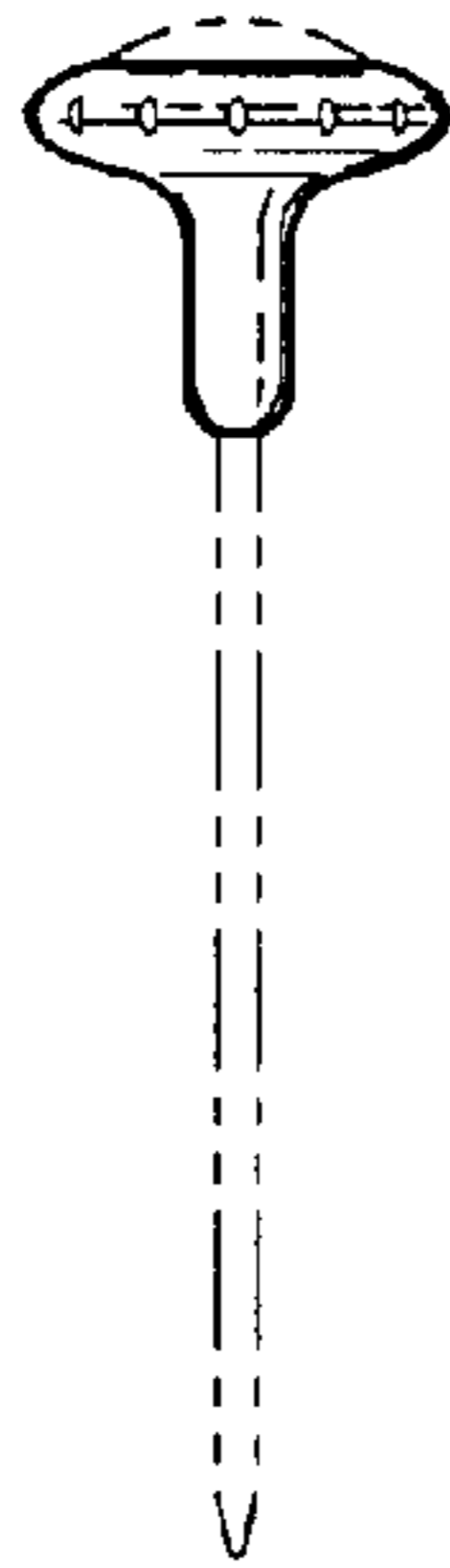

Fig. 31

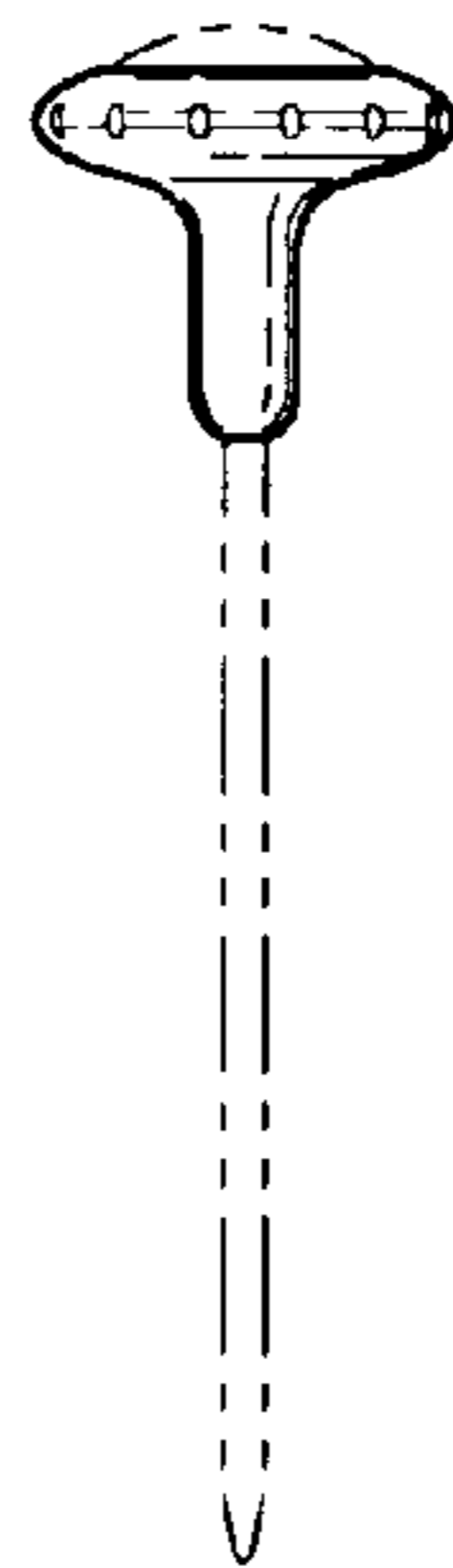

Fig. 32

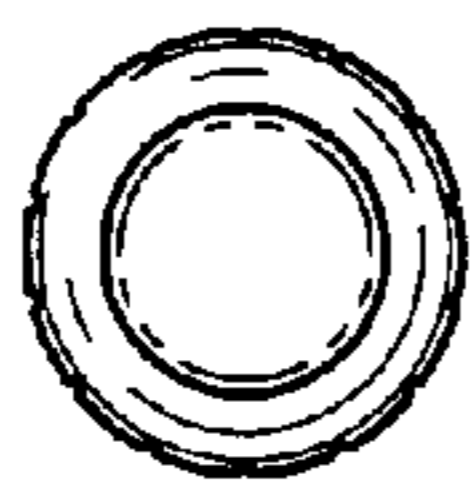

Fig. 33

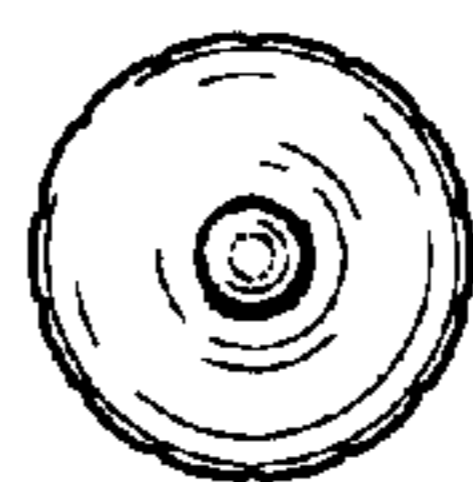

Fig. 34