



US00D485330S

(12) **United States Design Patent**
Shyu

(10) **Patent No.:** **US D485,330 S**
(45) **Date of Patent:** **** Jan. 13, 2004**

(54) **ELECTROLYTIC WATER GENERATING DEVICE**

Primary Examiner—Robin V. Taylor

(76) **Inventor:** **Wen Shing Shyu**, P.O. Box 63-298,
Taichung (TW), 406

(57) **CLAIM**

The ornamental design for an electrolytic water generating device, as shown and described.

(**) **Term:** **14 Years**

DESCRIPTION

(21) **Appl. No.:** **29/176,418**

FIG. 1 is a perspective view of an electrolytic water generating device showing my new design;

(22) **Filed:** **Feb. 20, 2003**

FIG. 2 is a front elevational view thereof;

(51) **LOC (7) Cl.** **23-01**

FIG. 3 is a rear elevational view thereof;

(52) **U.S. Cl.** **D23/207**

FIG. 4 is a top plan view thereof;

(58) **Field of Search** D23/200, 207,
D23/209; 210/232, 435, 190

FIG. 5 is a bottom plan view thereof;

(56) **References Cited**

FIG. 6 is a left side elevational view thereof; and,

U.S. PATENT DOCUMENTS

FIG. 7 is a right side elevational view thereof.

D295,656 S * 5/1988 Bond et al. D23/207

D453,951 S * 2/2002 Kim D23/207

* cited by examiner

1 Claim, 6 Drawing Sheets

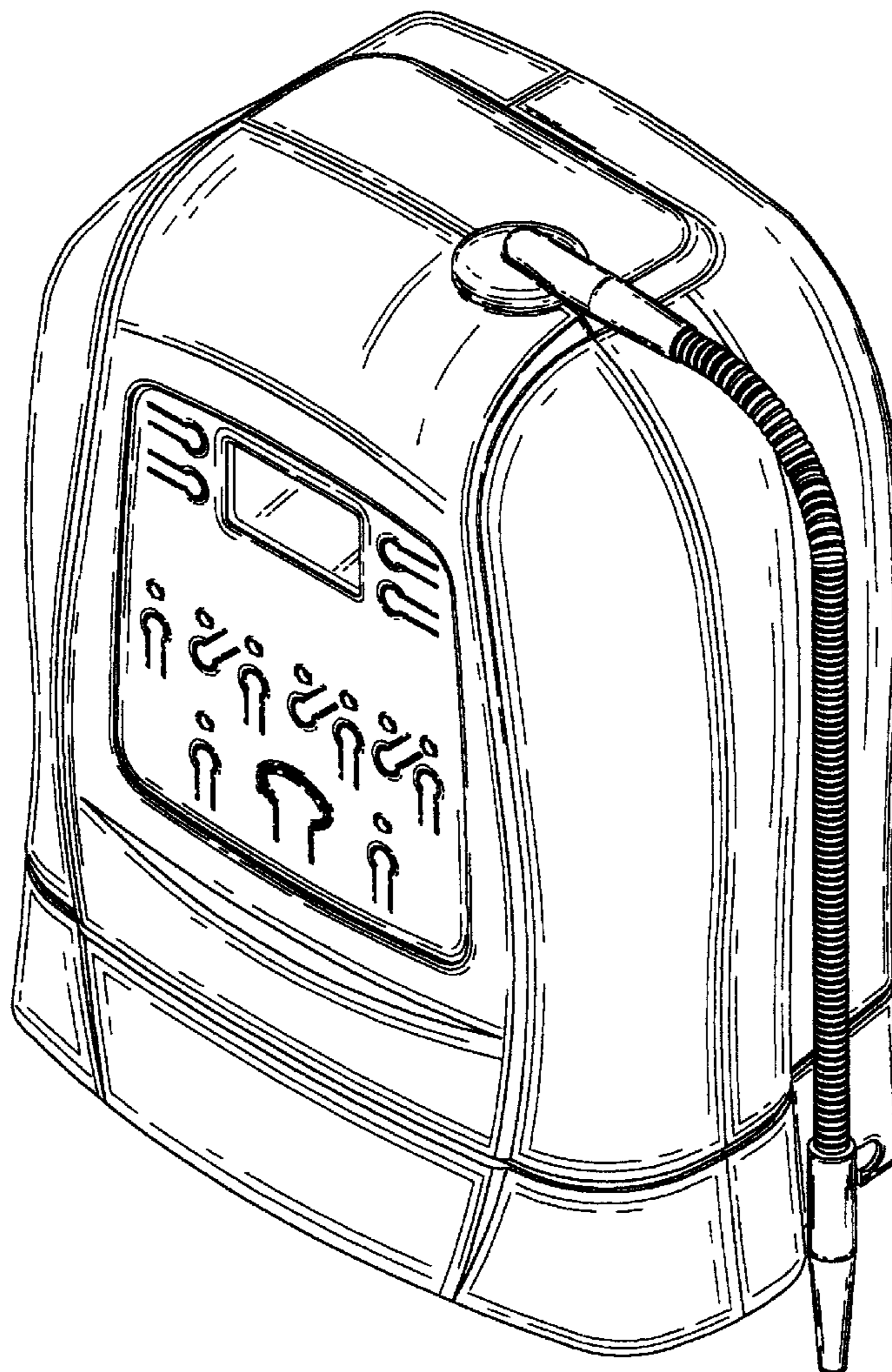

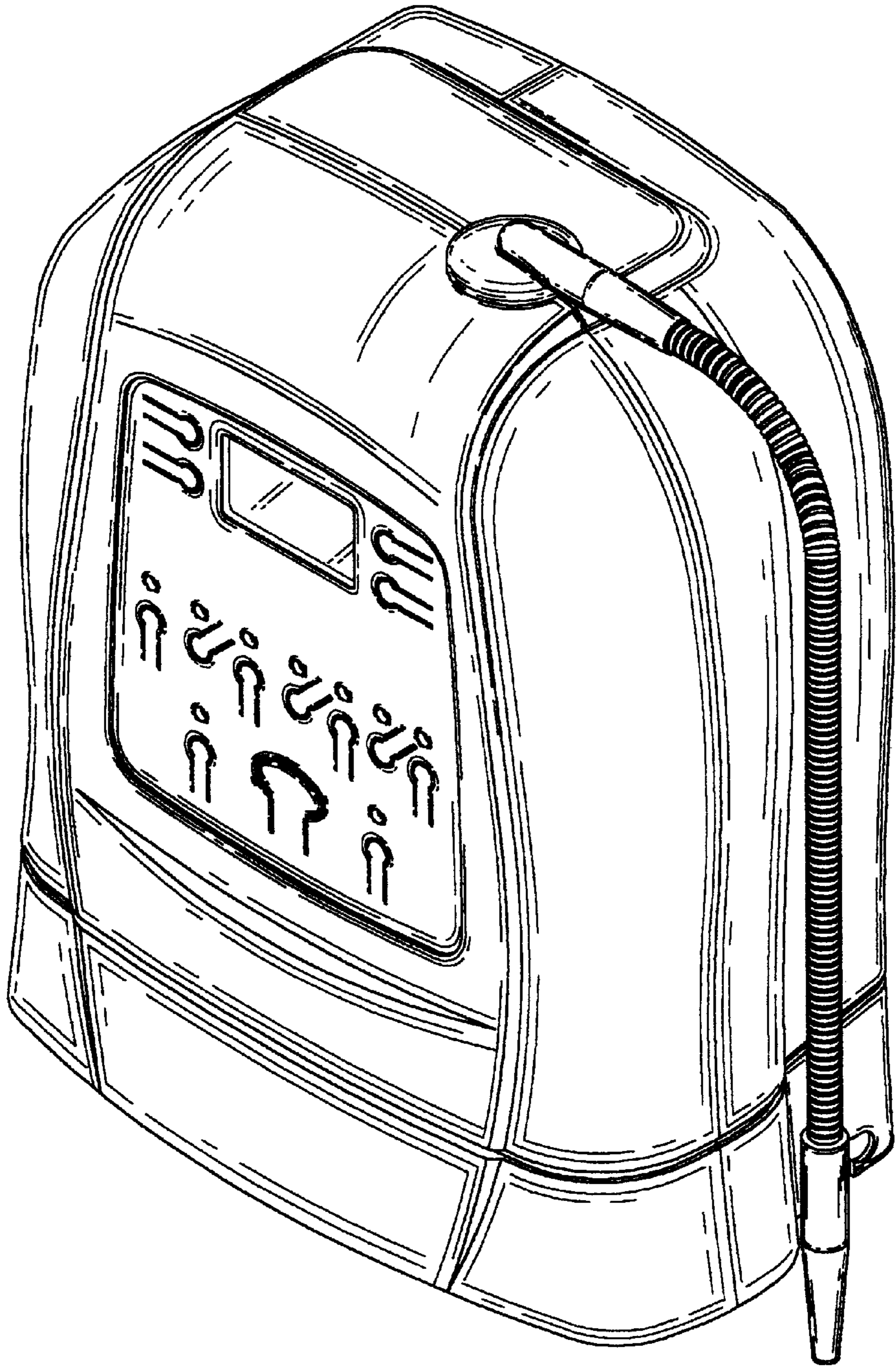

FIG. 1

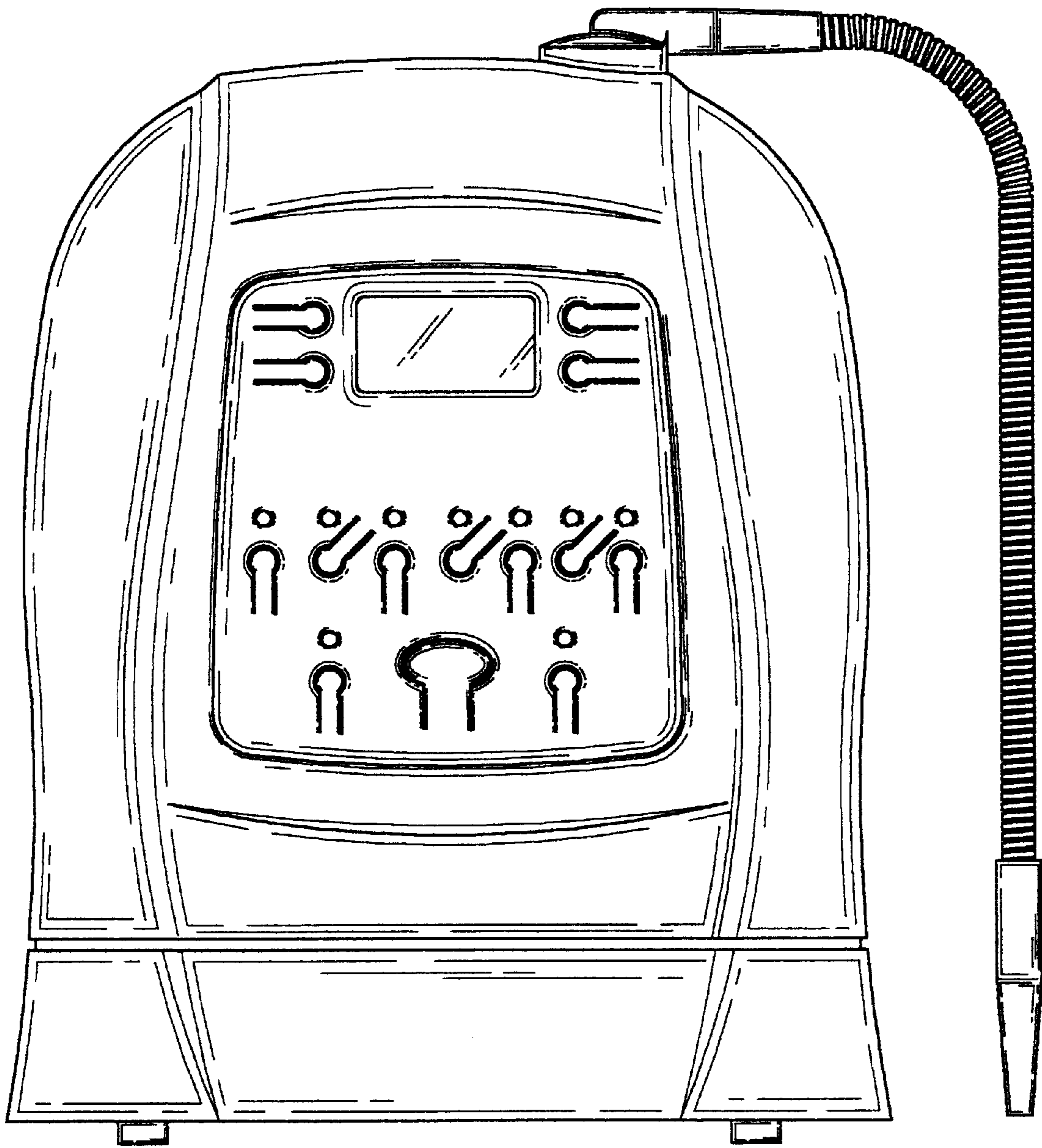

FIG. 2

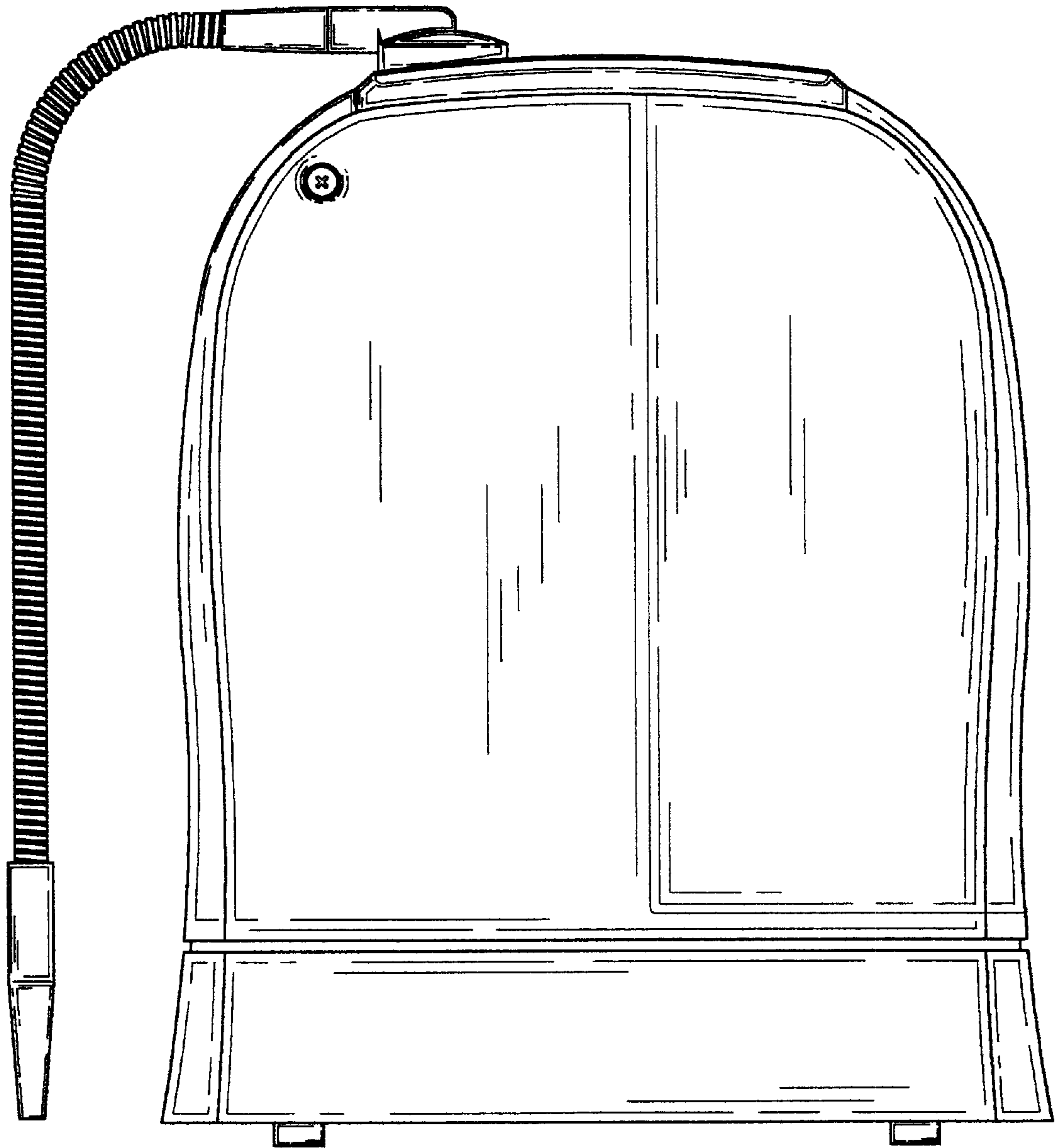

FIG. 3

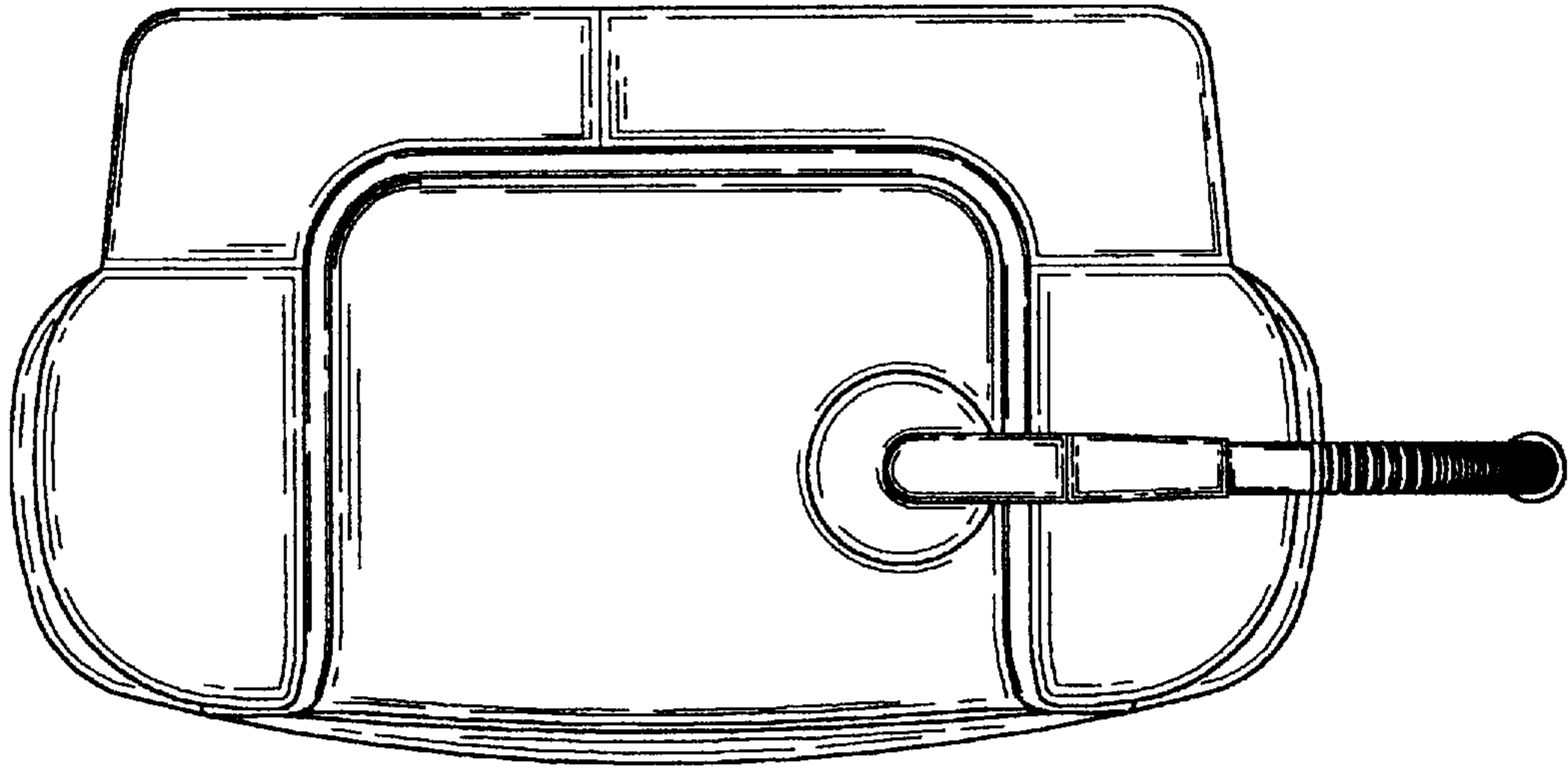

FIG. 4

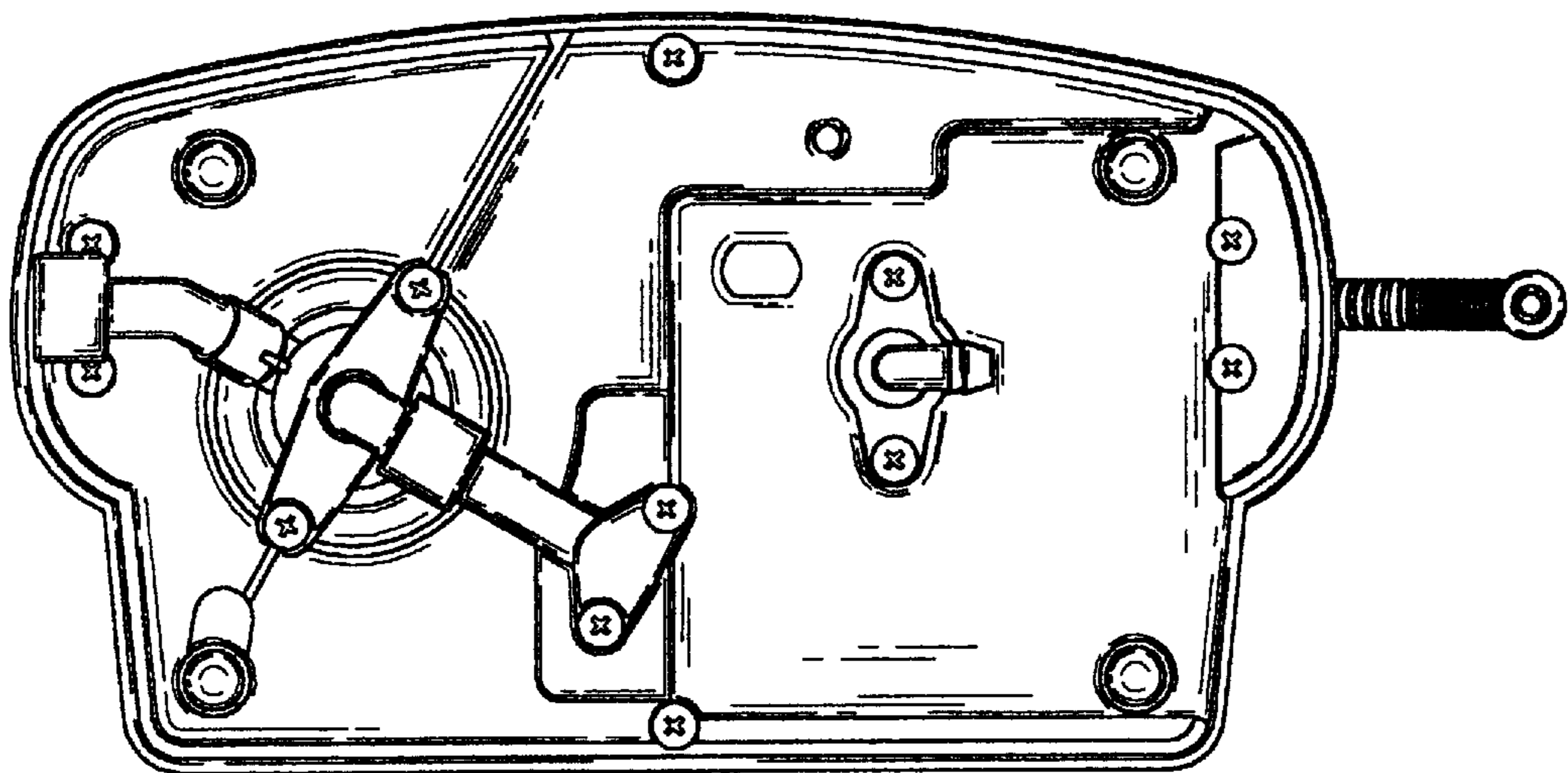

FIG. 5

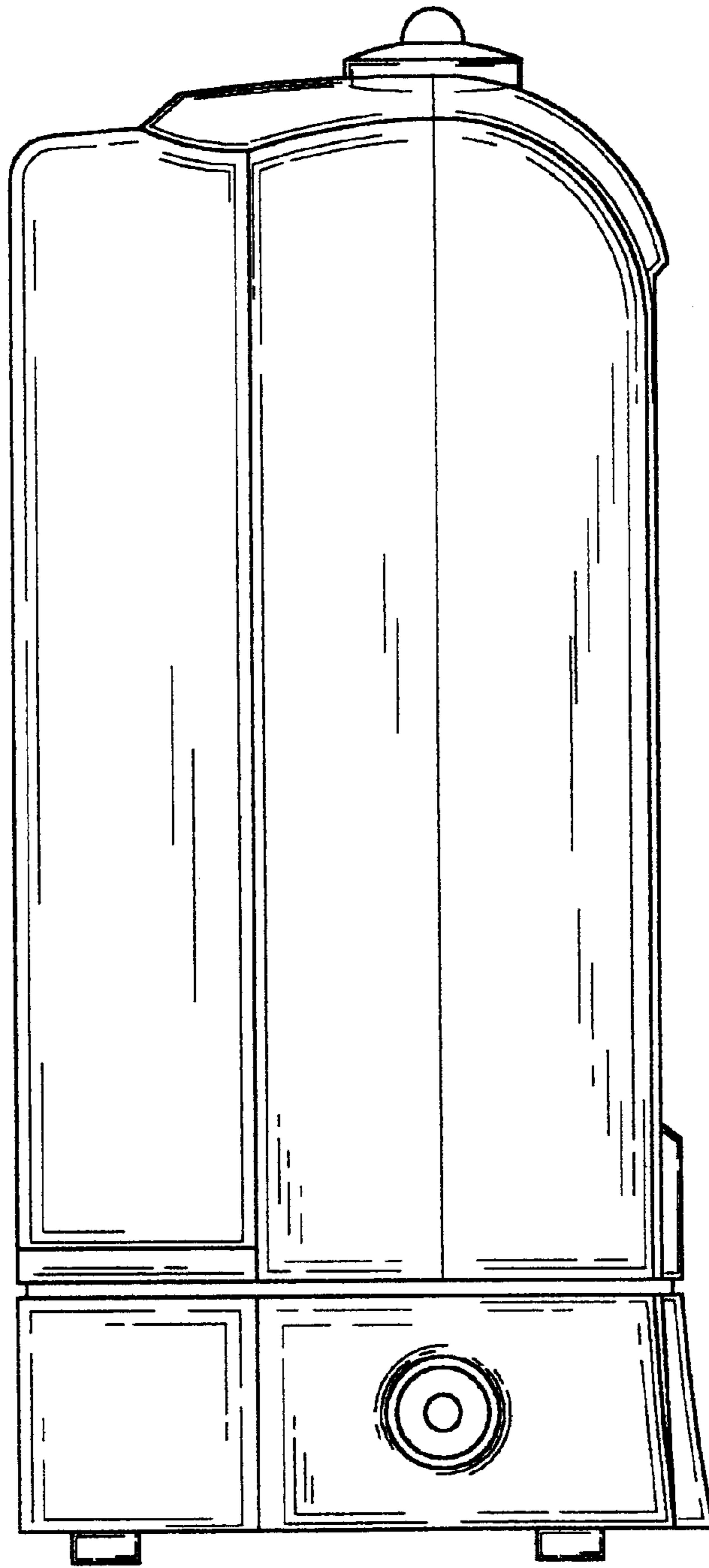

FIG. 6

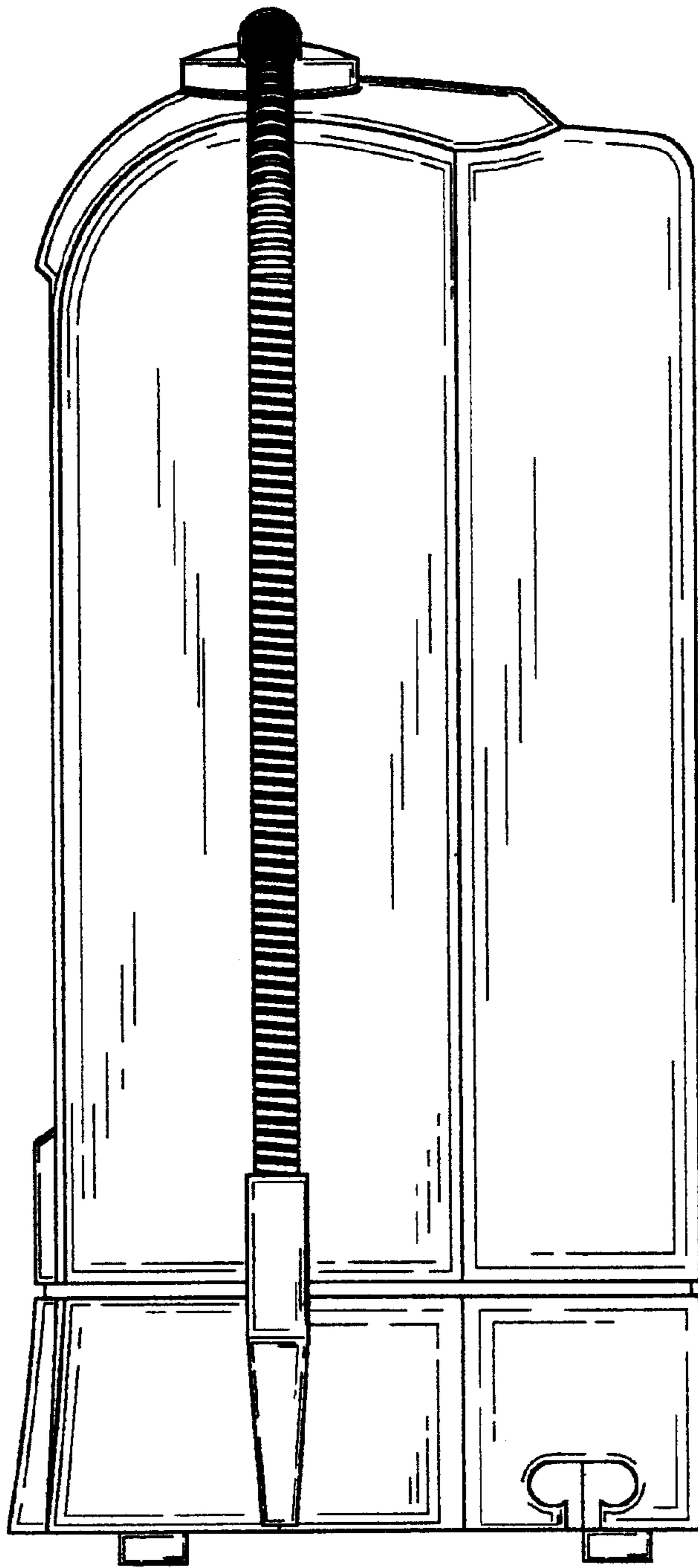

FIG. 7