



US00D485250S

(12) **United States Design Patent**  
**Harris et al.**

(10) **Patent No.:** **US D485,250 S**

(45) **Date of Patent:** **\*\* Jan. 13, 2004**

(54) **CD PLAYER**

(75) **Inventors:** **David Harris**, Nashua, NH (US); **Rudy Woodard**, Nashua, NH (US); **Tim Trzepacz**, Nashua, NH (US)

(73) **Assignee:** **Brookstone Company, Inc.**, Nashua, NH (US)

(\*\*) **Term:** **14 Years**

(21) **Appl. No.:** **29/162,757**

(22) **Filed:** **Jun. 20, 2002**

(51) **LOC (7) Cl.** ..... **14-01**

(52) **U.S. Cl.** ..... **D14/156**

(58) **Field of Search** ..... D14/135-136,  
D14/156-157, 167-168, 188, 193-198,  
257-258; 369/75.1, 75.2, 77.1, 77.2; 455/344,  
347, 350-351

(56) **References Cited**

**U.S. PATENT DOCUMENTS**

D331,238 S \* 11/1992 Lewis ..... D14/168

5,859,828 A \* 1/1999 Ishibashi ..... 369/75.1  
D435,534 S \* 12/2000 Horikoshi ..... D14/168  
D445,773 S \* 7/2001 Fenner ..... D14/156  
D455,142 S \* 4/2002 Saitoh ..... D14/168

\* cited by examiner

*Primary Examiner*—Nanda Bondade

(74) *Attorney, Agent, or Firm*—Hayes Soloway P.C.

(57) **CLAIM**

The ornamental design for a CD player, as shown and described.

**DESCRIPTION**

FIG. 1 is a front view thereof;  
FIG. 2 is a rear view thereof;  
FIG. 3 is a right-side view thereof;  
FIG. 4 is a left-side view thereof;  
FIG. 5 is a top plan view thereof;  
FIG. 6 is a bottom plan view thereof; and,  
FIG. 7 is a front perspective view thereof.

**1 Claim, 6 Drawing Sheets**

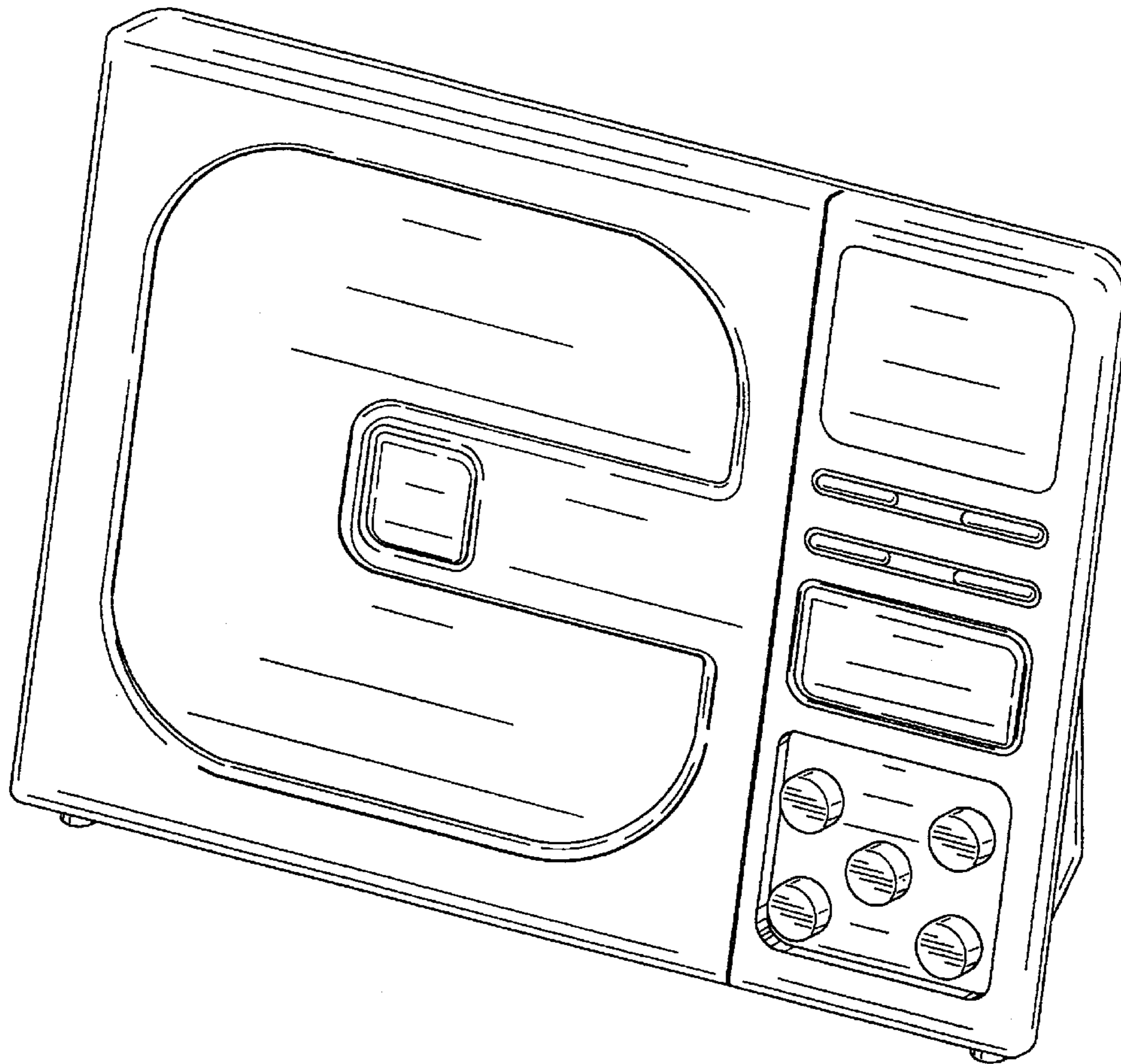

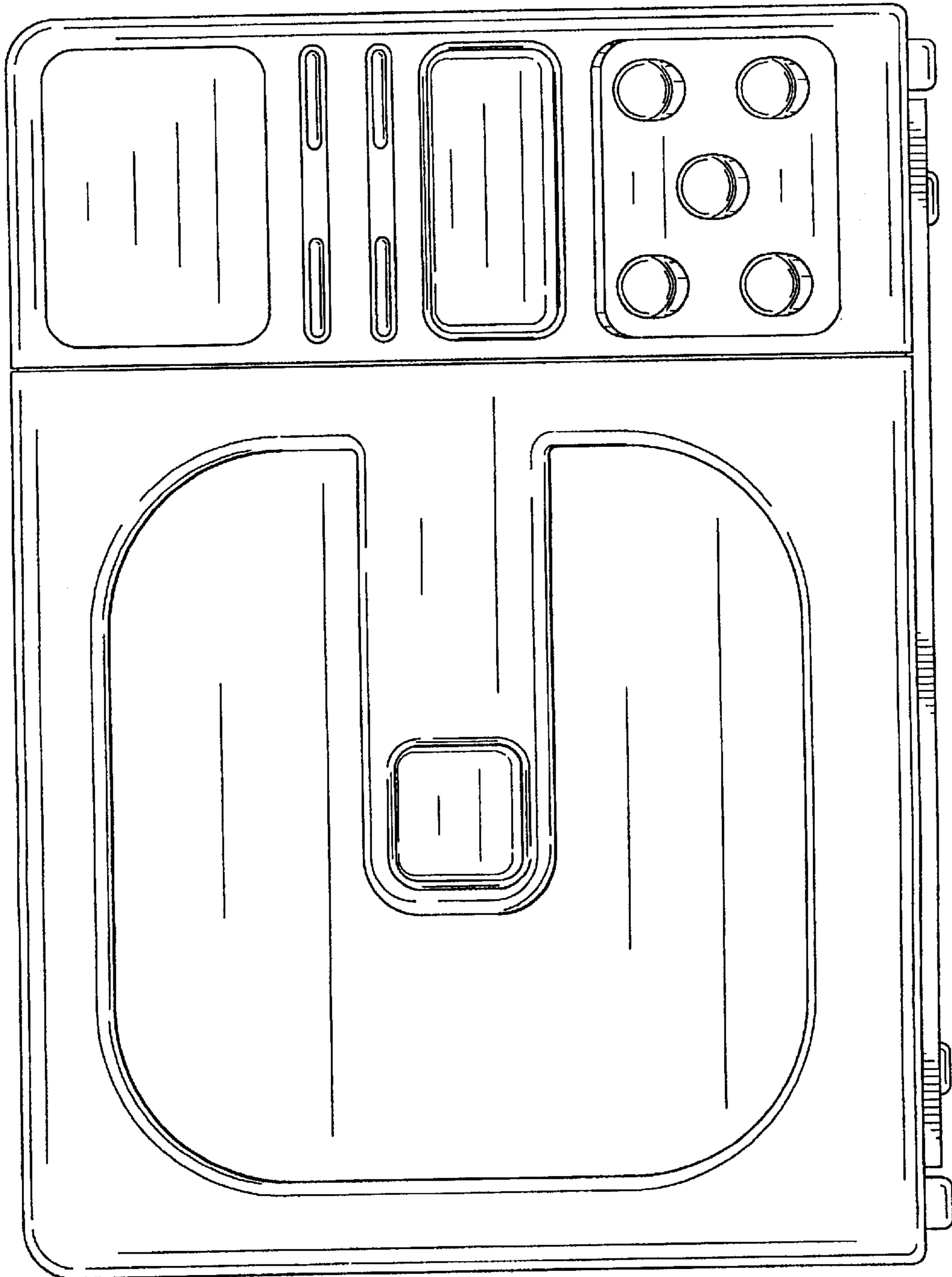

FIG. 1

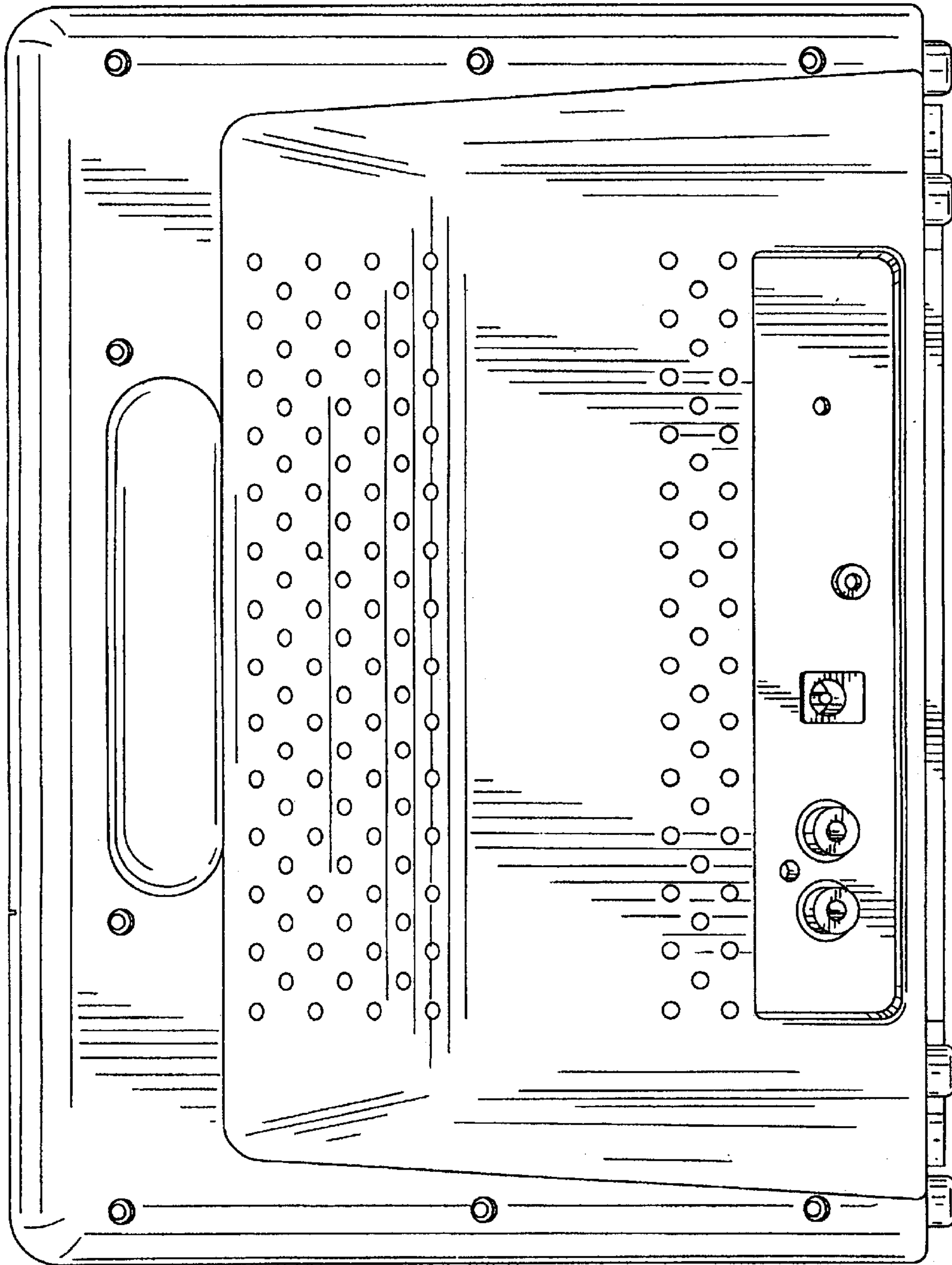

FIG. 2

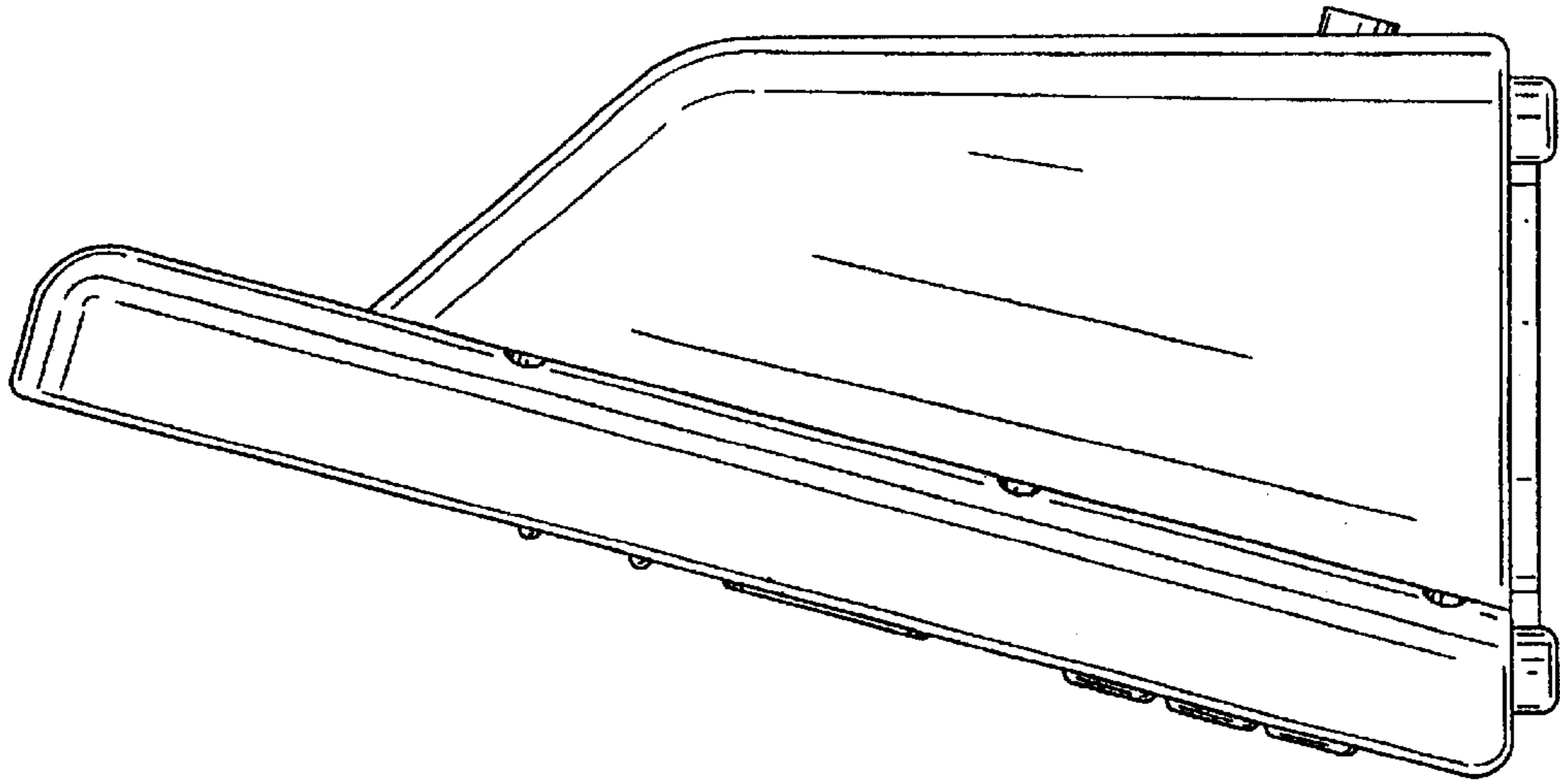

FIG. 4

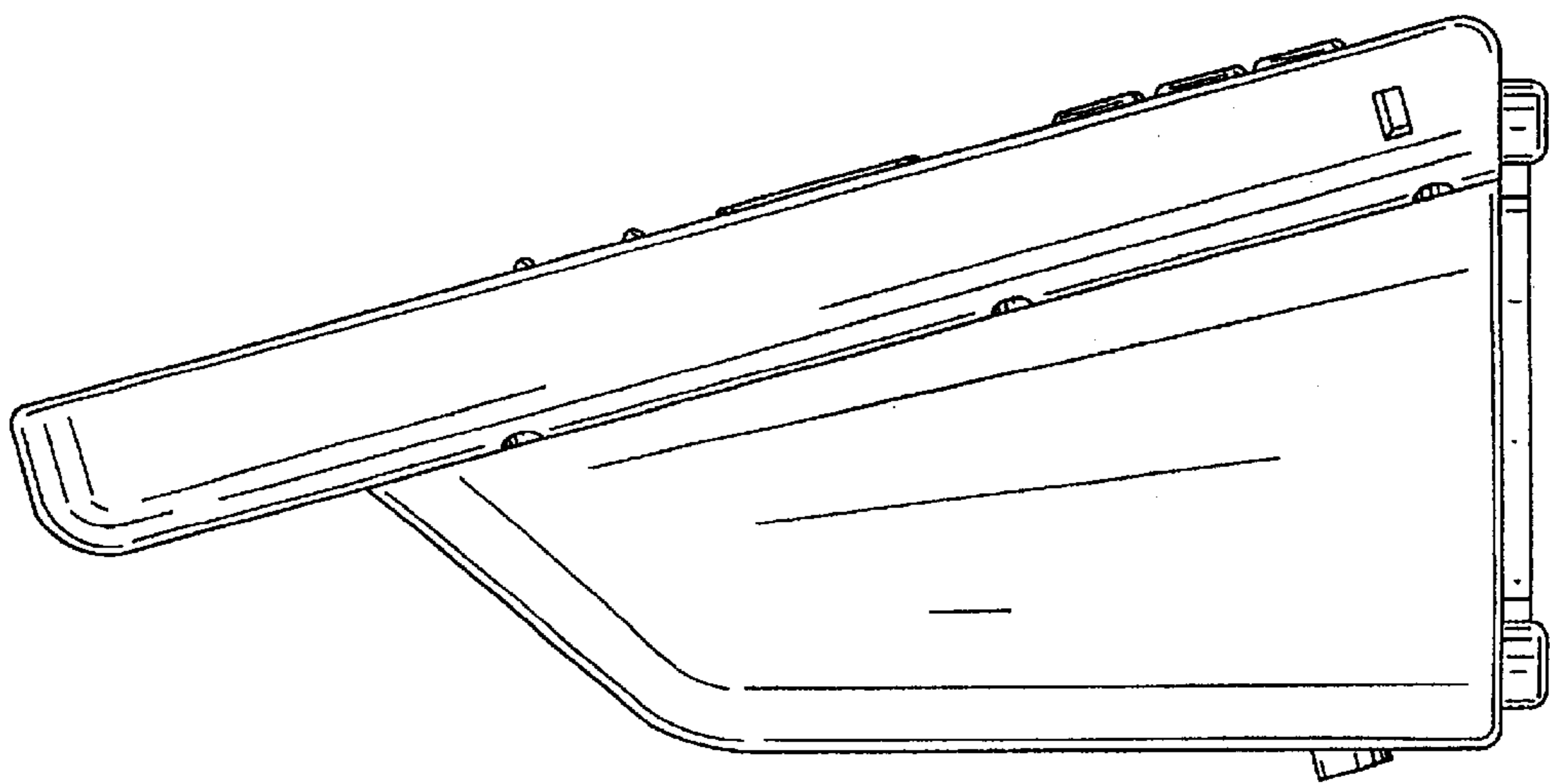

FIG. 3

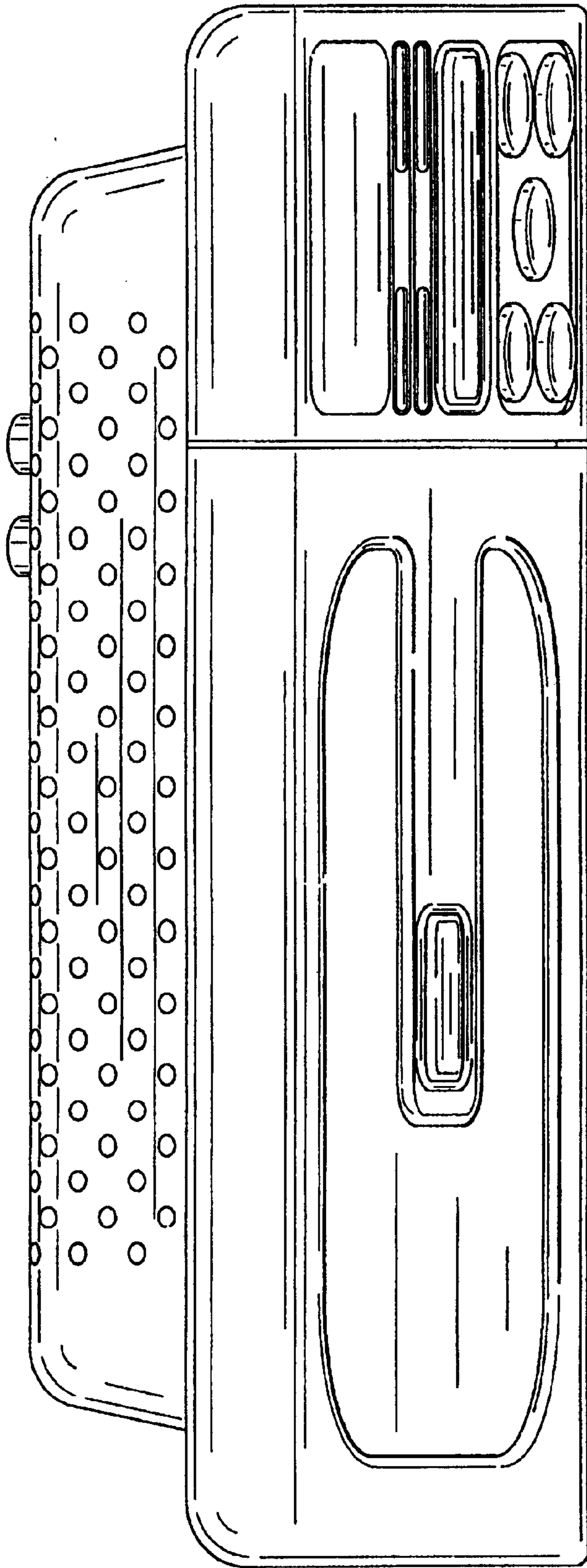

FIG. 5

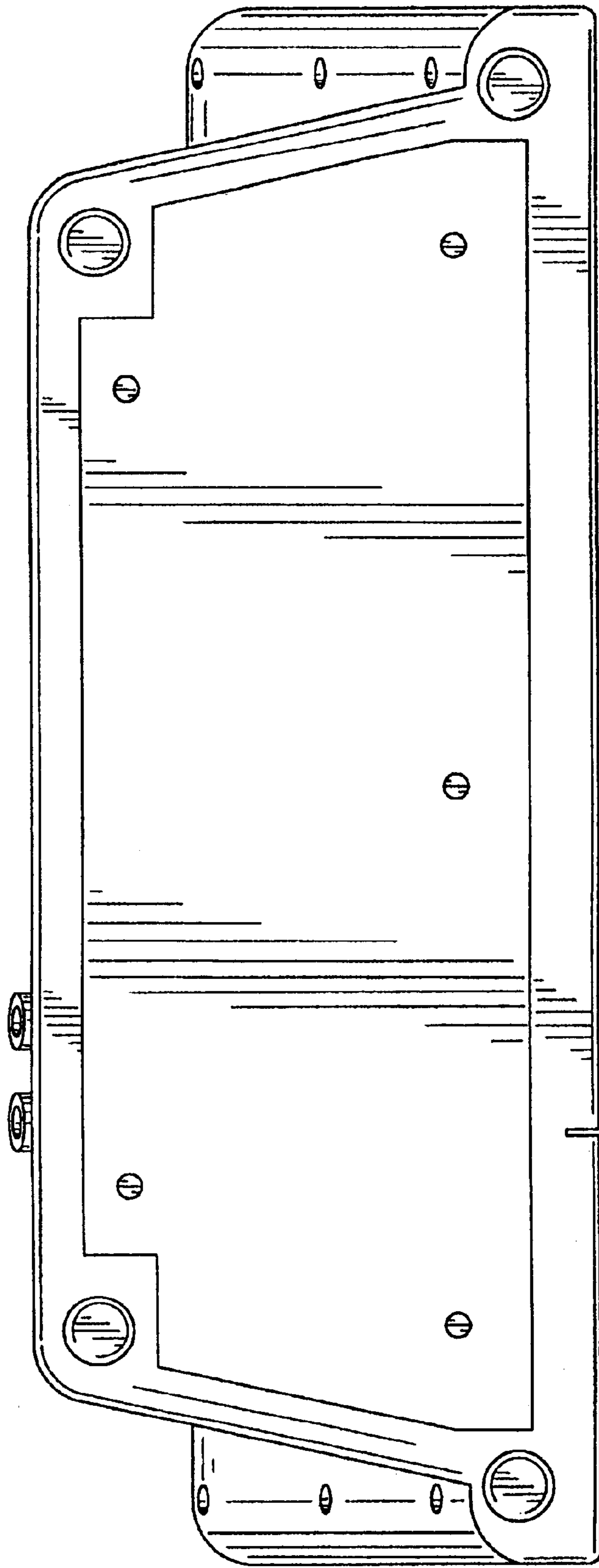

FIG. 6

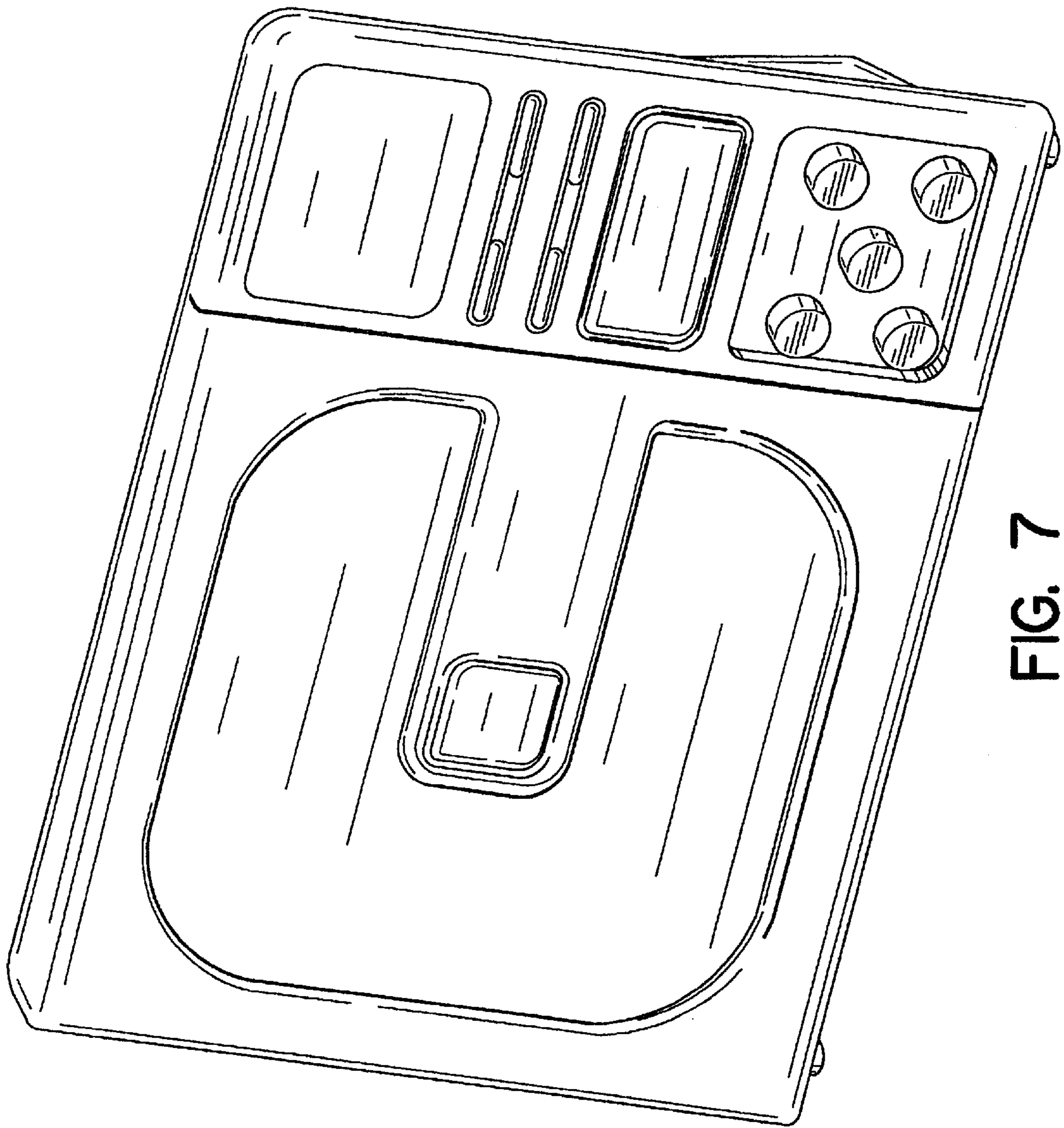

FIG. 7