



US00D485237S

(12) **United States Design Patent**
Hwang et al.

(10) **Patent No.:** **US D485,237 S**
(45) **Date of Patent:** **** Jan. 13, 2004**

(54) **SFP PACKAGING WITH A PULL-TAB**

(75) Inventors: **Jenq-Yih Hwang**, Irvine, CA (US);
Wayne Huang, Santa Clara, CA (US);
Eddy Wong, Irvine, CA (US); **Hung Tieu**, Alhambra, CA (US)

(73) Assignee: **Hon Hai Precision Ind. Co., Ltd.**,
Taipei Hsien (TW)

(**) Term: **14 Years**

(21) Appl. No.: **29/179,942**

(22) Filed: **Apr. 16, 2003**

(51) **LOC (7) Cl.** **13-03**

(52) **U.S. Cl.** **D13/123; D13/133**

(58) **Field of Search** **D13/122, 123,**
D13/133, 147, 153, 184, 199; 439/76.1,
357, 567, 607, 609; 206/719, 721, 722;
361/752, 800

(56) **References Cited**

U.S. PATENT DOCUMENTS

6,178,096 B1 * 1/2001 Flickinger et al. 361/816
6,206,730 B1 * 3/2001 Avery et al. 439/609
6,351,394 B1 * 2/2002 Cunningham 361/818

6,430,053 B1 * 8/2002 Peterson et al. 361/728
6,434,015 B1 * 8/2002 Hwang 361/754
6,485,322 B1 * 11/2002 Branch et al. 439/357
D467,544 S * 12/2002 Hwang D13/123

OTHER PUBLICATIONS

Agilent Technologies, Small form factor Pluggable Transceiver, Jun. 2002, From Internet.*

* cited by examiner

Primary Examiner—Philip S. Hyder

(74) *Attorney, Agent, or Firm*—Wei Te Chung

(57) **CLAIM**

The ornamental design for a SFP packaging with a pull-tab, as shown and described.

DESCRIPTION

FIG. 1 is a perspective view of a SFP packaging with a pull-tab showing our new design;
FIG. 2 is a front elevational view thereof;
FIG. 3 is a rear elevational view thereof;
FIG. 4 is a left side view thereof;
FIG. 5 is a right side view thereof;
FIG. 6 is a top plan view thereof; and,
FIG. 7 is a bottom plan view thereof.

1 Claim, 4 Drawing Sheets

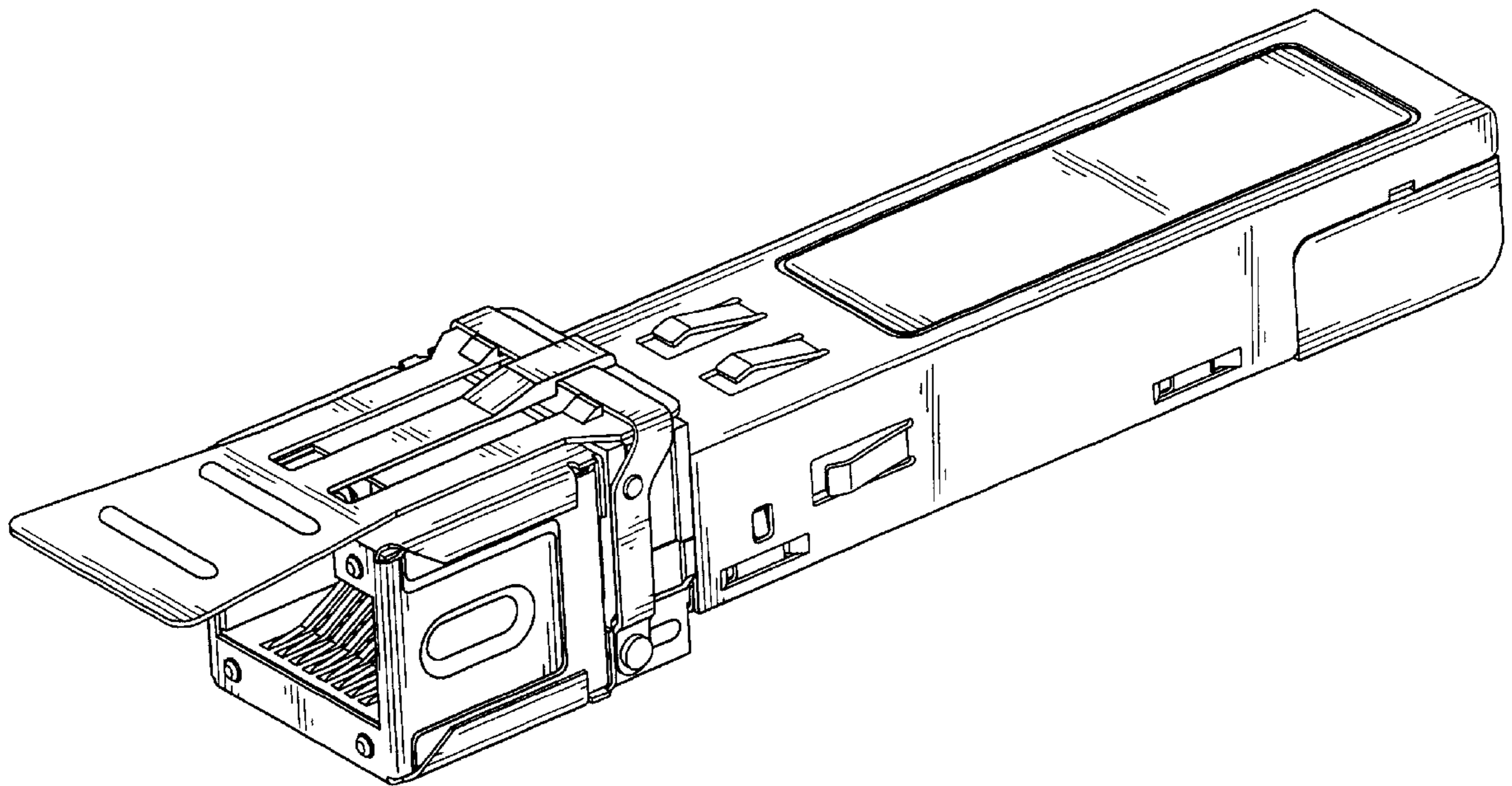

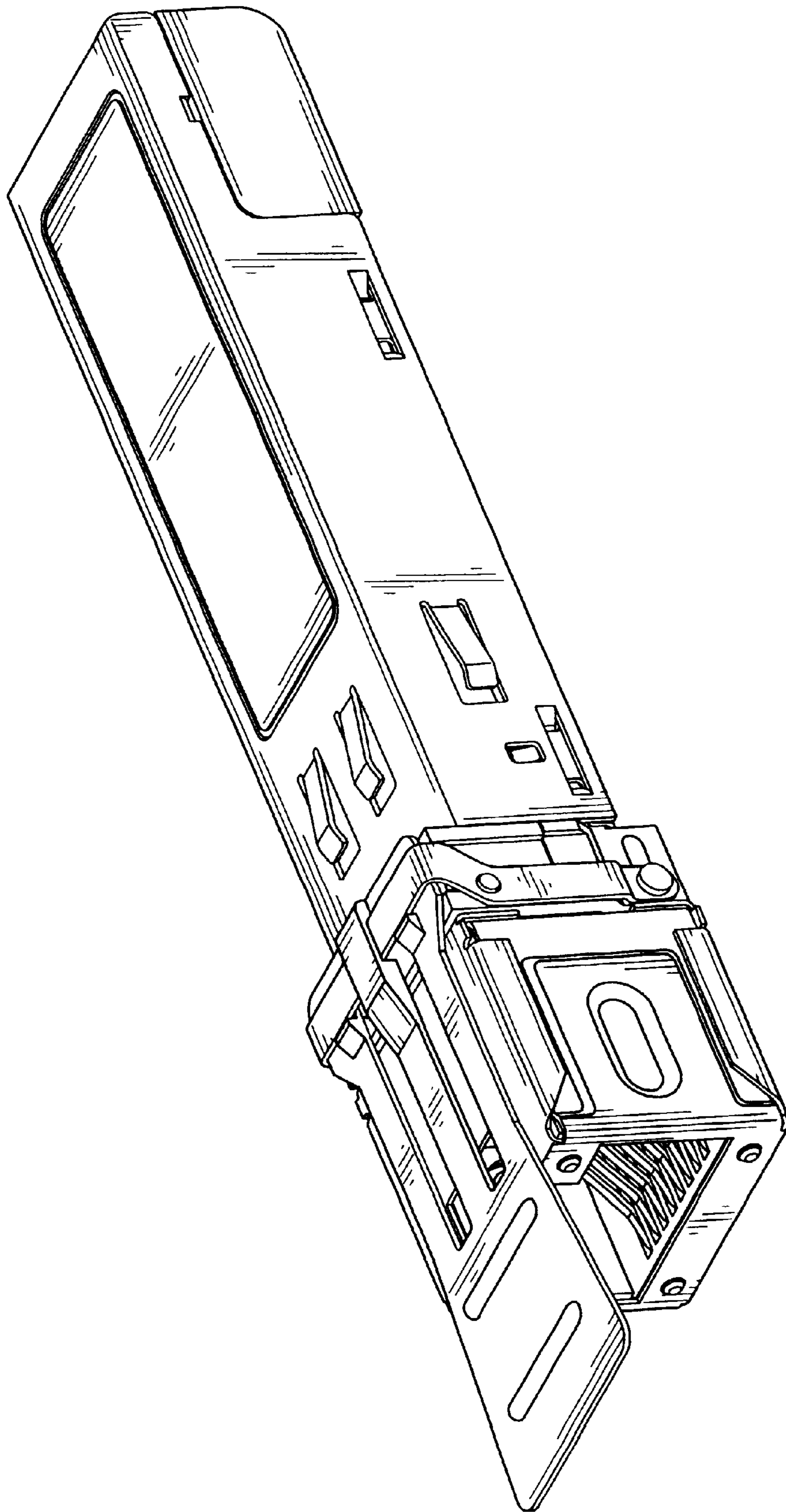

FIG. 1

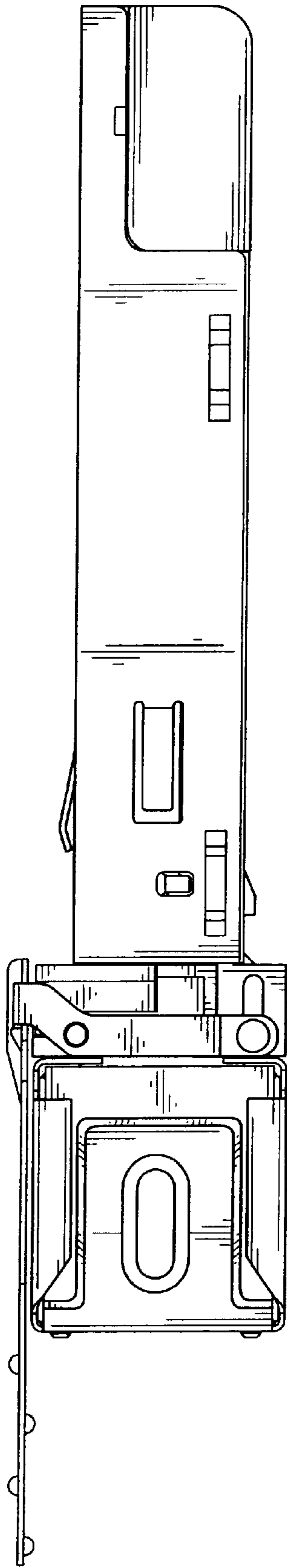

FIG. 2

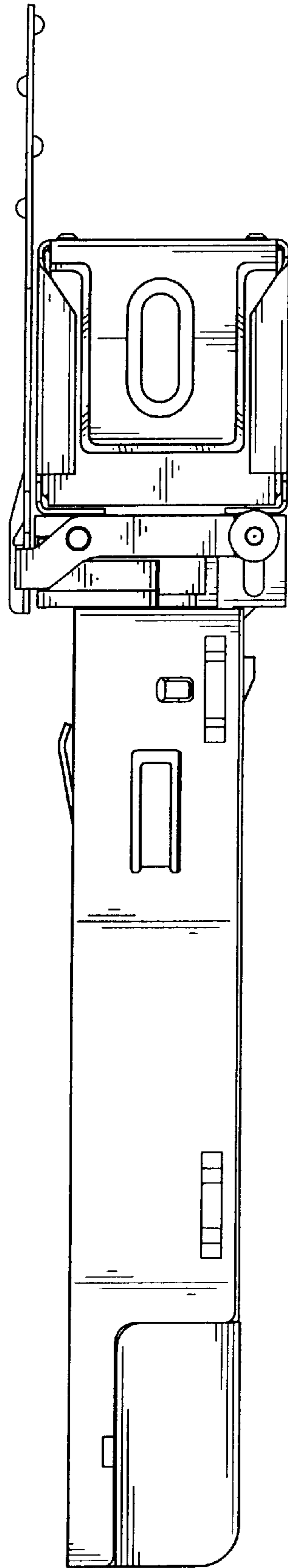

FIG. 3

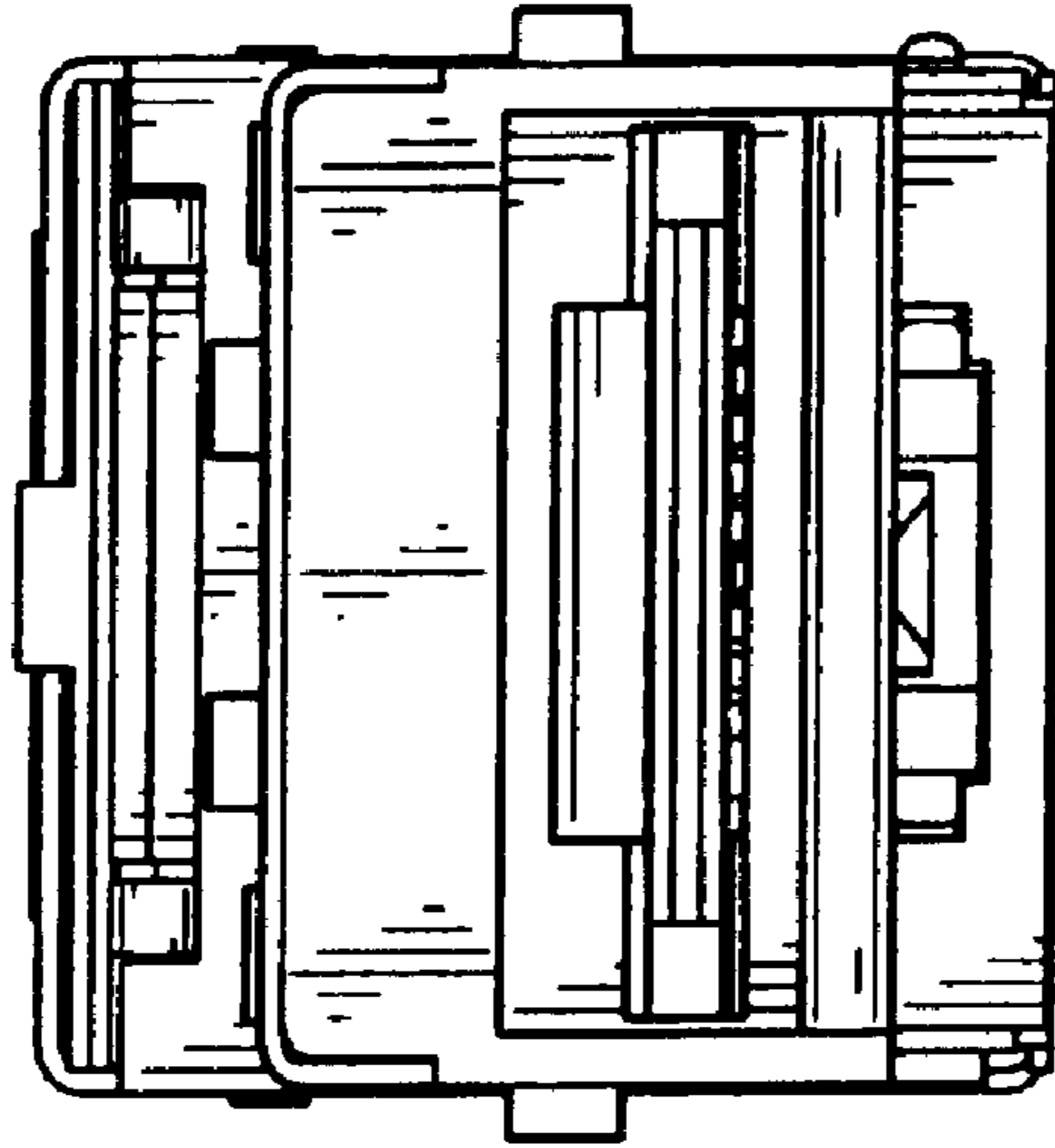

FIG. 5

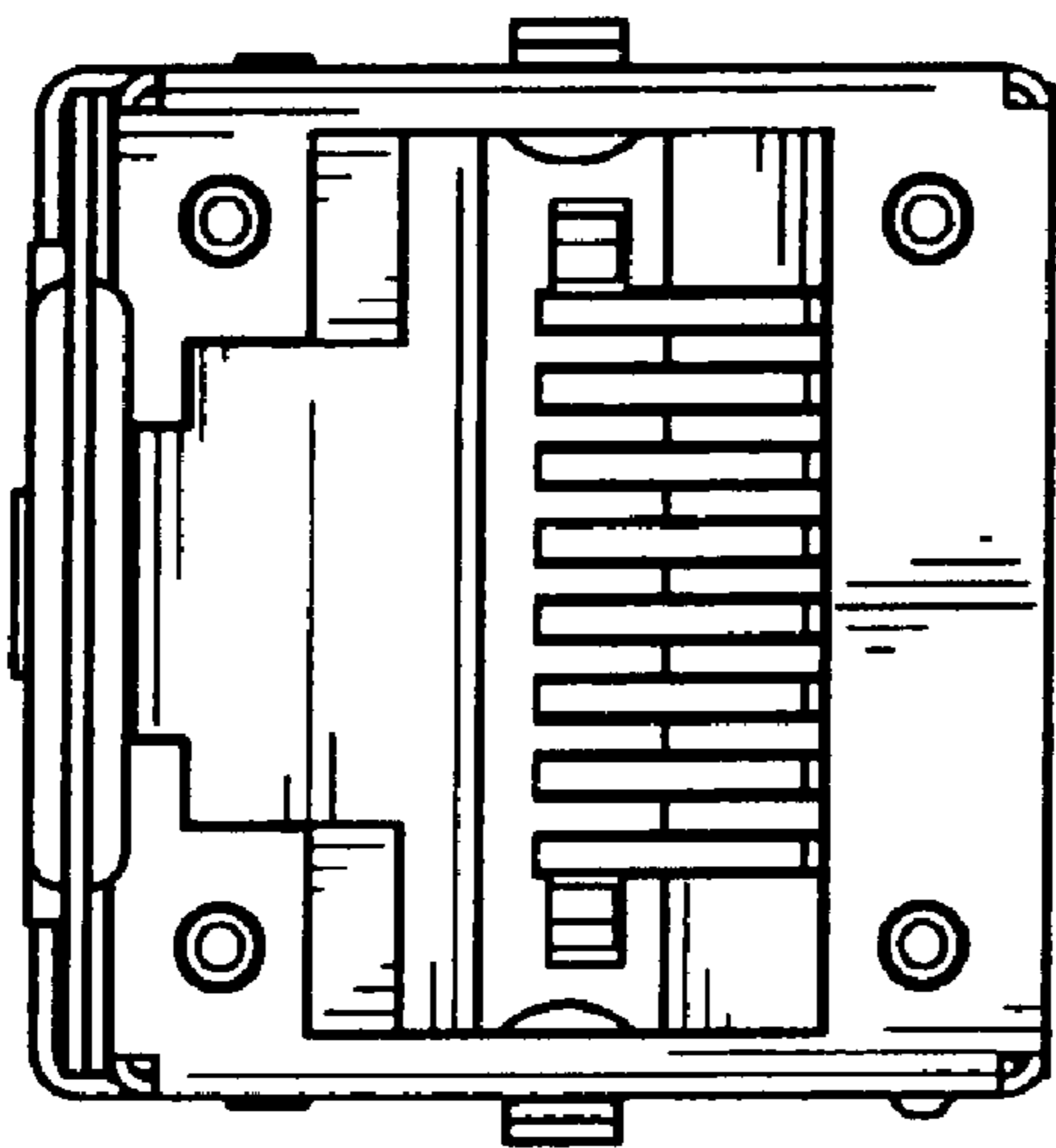

FIG. 4

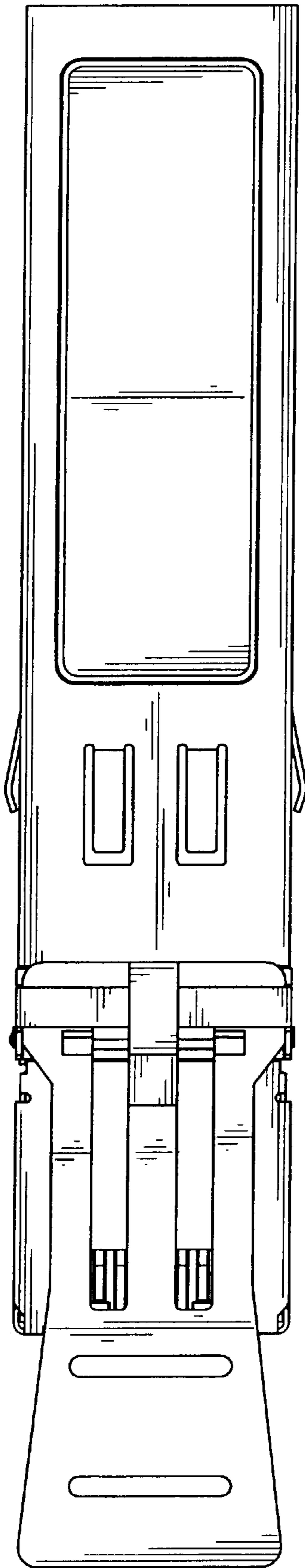

FIG. 6

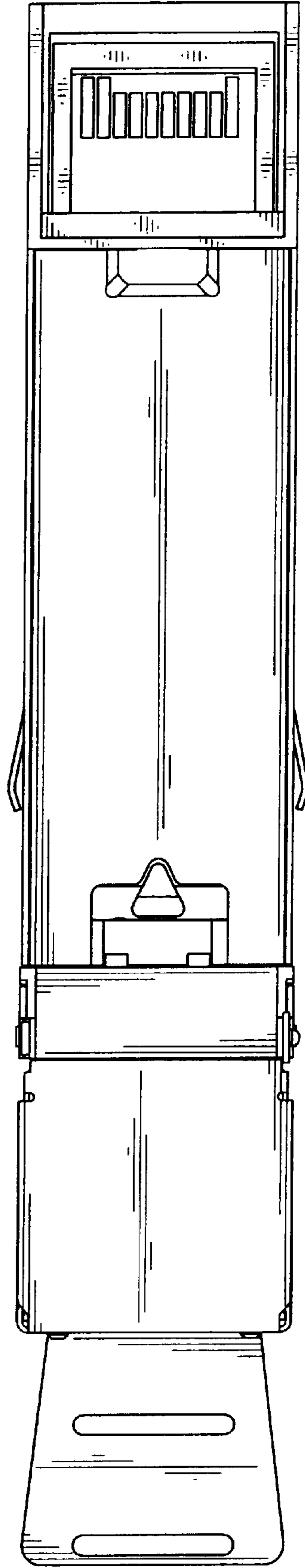

FIG. 7