



US00D485066S

(12) **United States Design Patent**  
**Wolf**

(10) **Patent No.:** **US D485,066 S**

(45) **Date of Patent:** **\*\* Jan. 13, 2004**

(54) **JEWELRY CASE**

(75) **Inventor:** **Simon Wolf, Malibu, CA (US)**

(73) **Assignee:** **Wolf Designs, Inc., Malibu, CA (US)**

(\*\*) **Term:** **14 Years**

(21) **Appl. No.:** **29/178,488**

(22) **Filed:** **Mar. 26, 2003**

(51) **LOC (7) Cl.** ..... **03-01**

(52) **U.S. Cl.** ..... **D3/295; D3/291; D3/296;**  
**D3/903**

(58) **Field of Search** ..... **D3/273, 276, 284,**  
**D3/291, 294, 295, 296, 297, 903; 190/102,**  
**109, 110, 111, 112; 206/6.1, 235, 457, 566,**  
**581**

(56) **References Cited**

**U.S. PATENT DOCUMENTS**

2,564,122	A	8/1951	Mele	
2,738,250	A	3/1956	Mele et al.	
D203,305	S	12/1965	Ax	
4,195,727	A	4/1980	Mele	206/45
D270,980	S	10/1983	Haigh	
D325,123	S	* 4/1992	Tiramani	D3/275
5,127,719	A	7/1992	Battista	312/204
D351,283	S	* 10/1994	Wolff	D3/281
D361,430	S	* 8/1995	Mohundro	D3/297
5,692,605	A	* 12/1997	Lai	206/6.1
5,823,328	A	10/1998	Fomby	206/8
D416,135	S	* 11/1999	Chen	D3/276
D417,783	S	* 12/1999	Wolf	D3/297

D418,298	S	* 1/2000	Wolf	D3/297
6,059,388	A	5/2000	Wheatley, Jr.	312/246
6,322,123	B1	11/2001	Garrison et al.	296/26.1
D451,671	S	12/2001	Wolf	D3/275
D454,687	S	3/2002	Wolf	D3/275
D455,550	S	* 4/2002	Wolf	D3/275
D455,902	S	* 4/2002	Wolf	D3/275
D457,315	S	* 5/2002	Wolf	D3/290
D467,427	S	* 12/2002	Wolf	D3/289
D467,428	S	* 12/2002	Wolf	D3/291

\* cited by examiner

*Primary Examiner*—Philip S. Hyder

(74) *Attorney, Agent, or Firm*—Cislo & Thomas LLP

(57) **CLAIM**

The ornamental design for a jewelry case, as shown and described herein.

**DESCRIPTION**

FIG. 1. Is a front perspective view of my jewelry case as shown in the closed position;

FIG. 2. Is a front perspective view of my jewelry case shown in the open position with the dotted lines showing being for illustrative purposes only for which no claim is made;

FIG. 3. Is a top plan view thereof;

FIG. 4. Is a bottom plan view thereof;

FIG. 5. Is a front view thereof;

FIG. 6. Is a rear view thereof; and,

FIG. 7. Is a right side elevational view of my jewelry case depicted in FIG. 1 with the left side being a mirror image thereof.

**1 Claim, 5 Drawing Sheets**

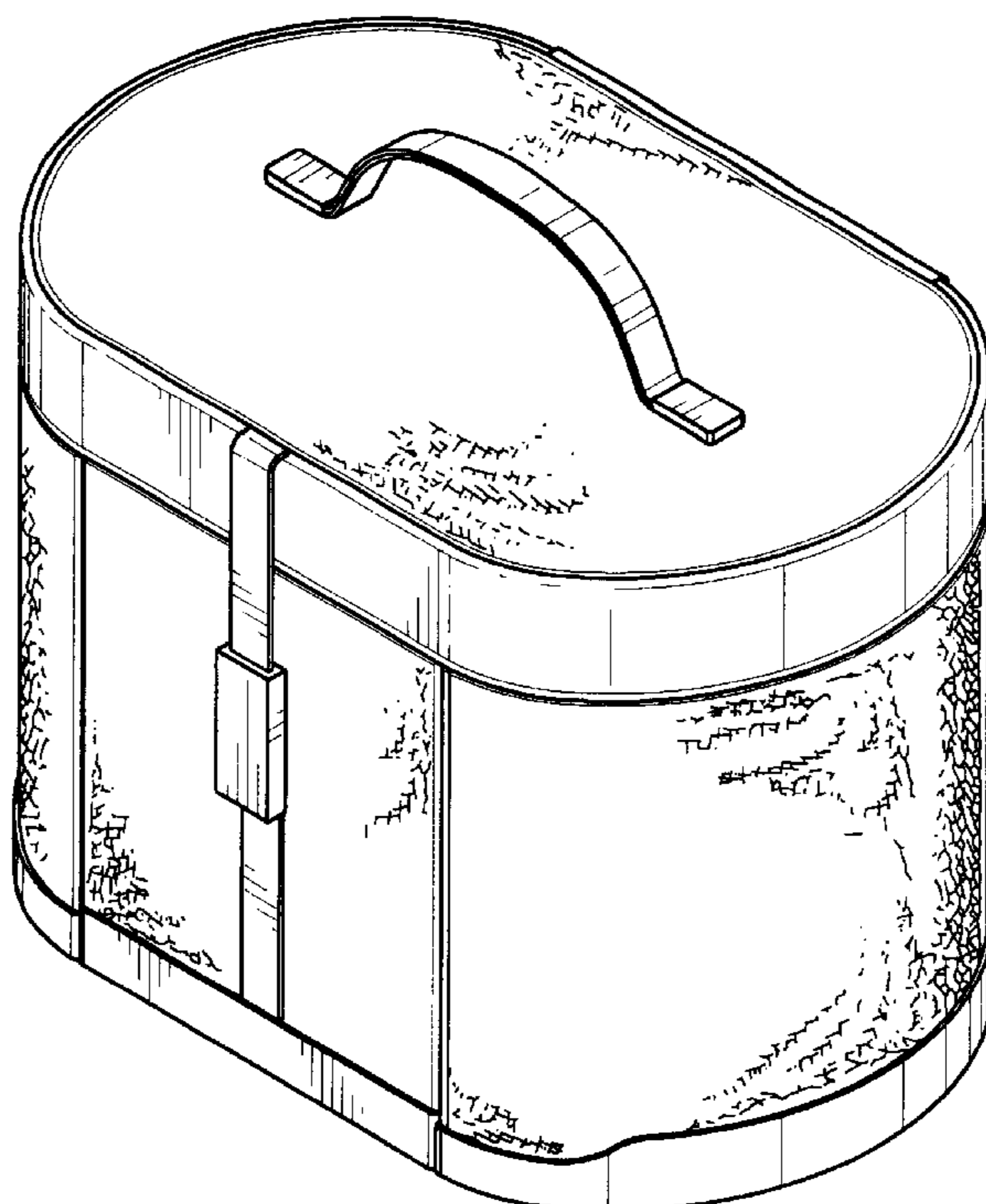

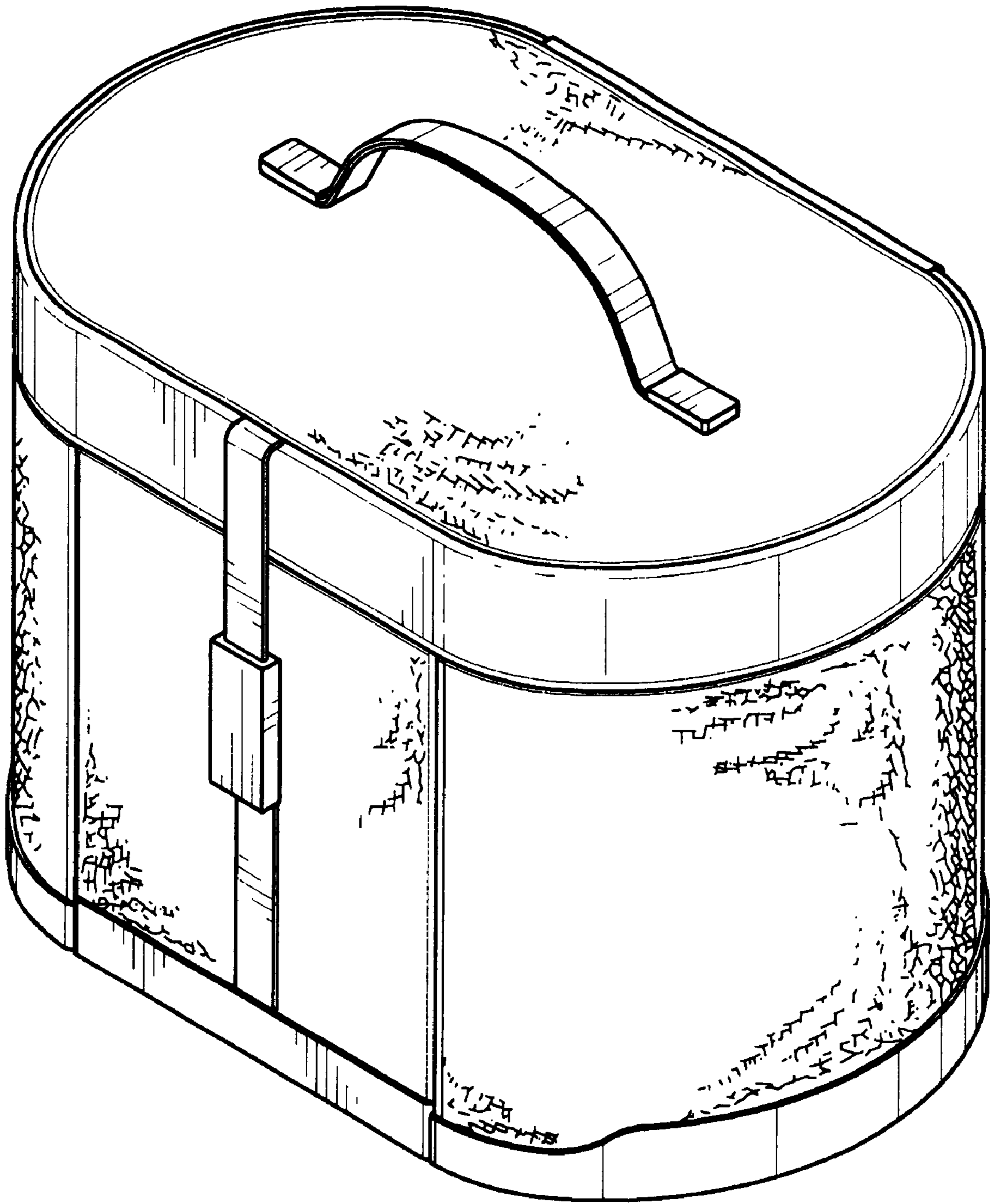

FIG. 1

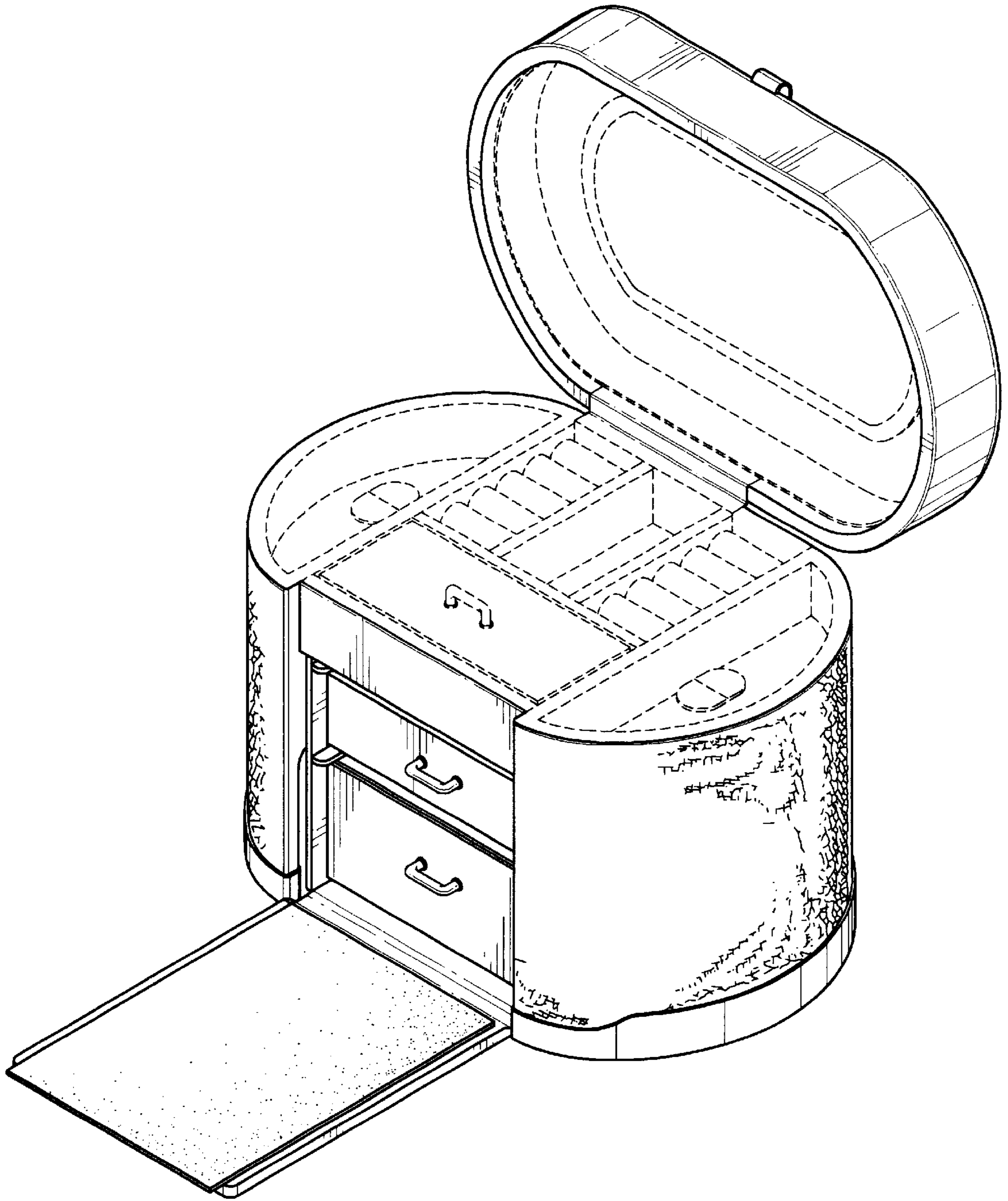

FIG. 2

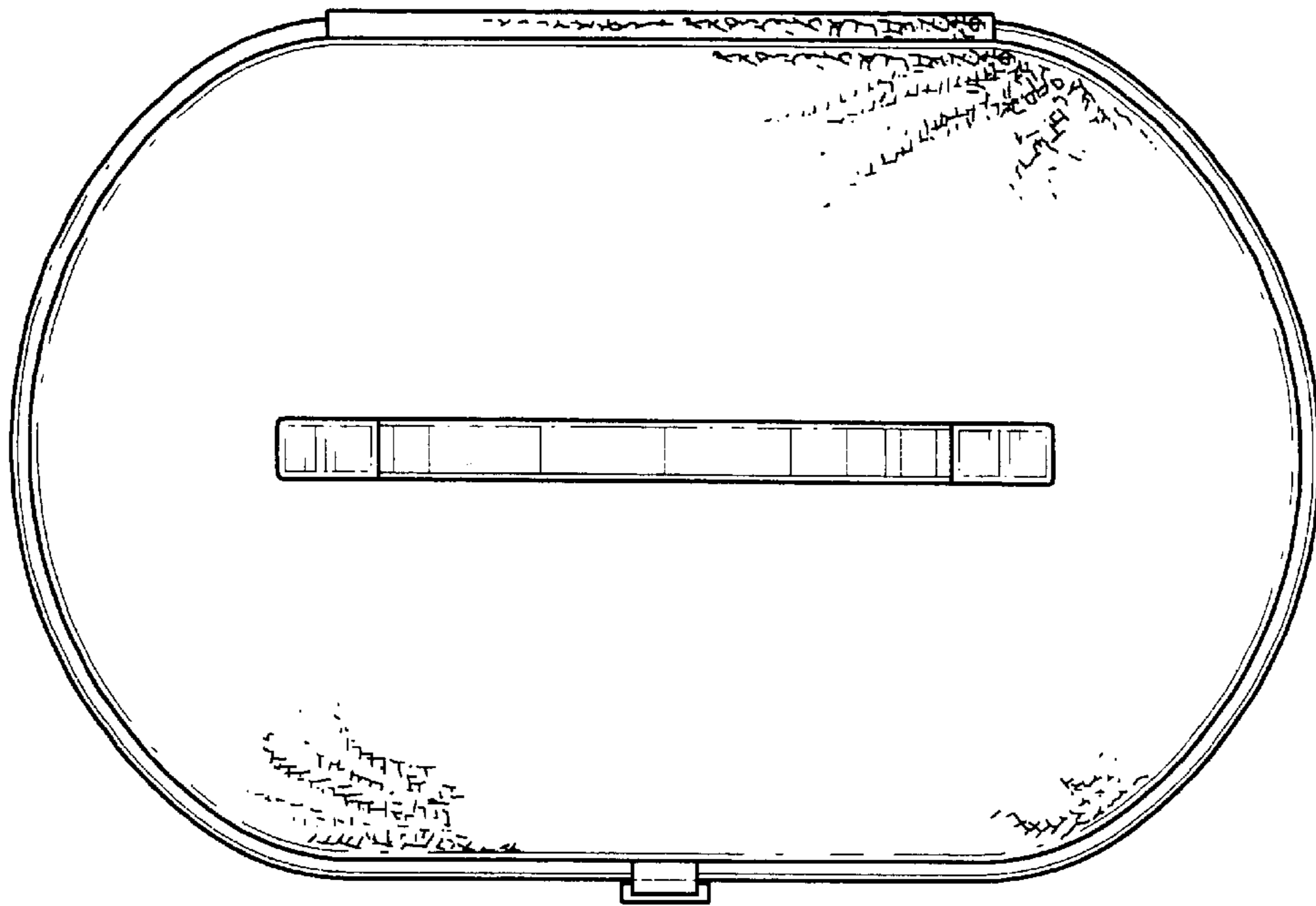

FIG. 3

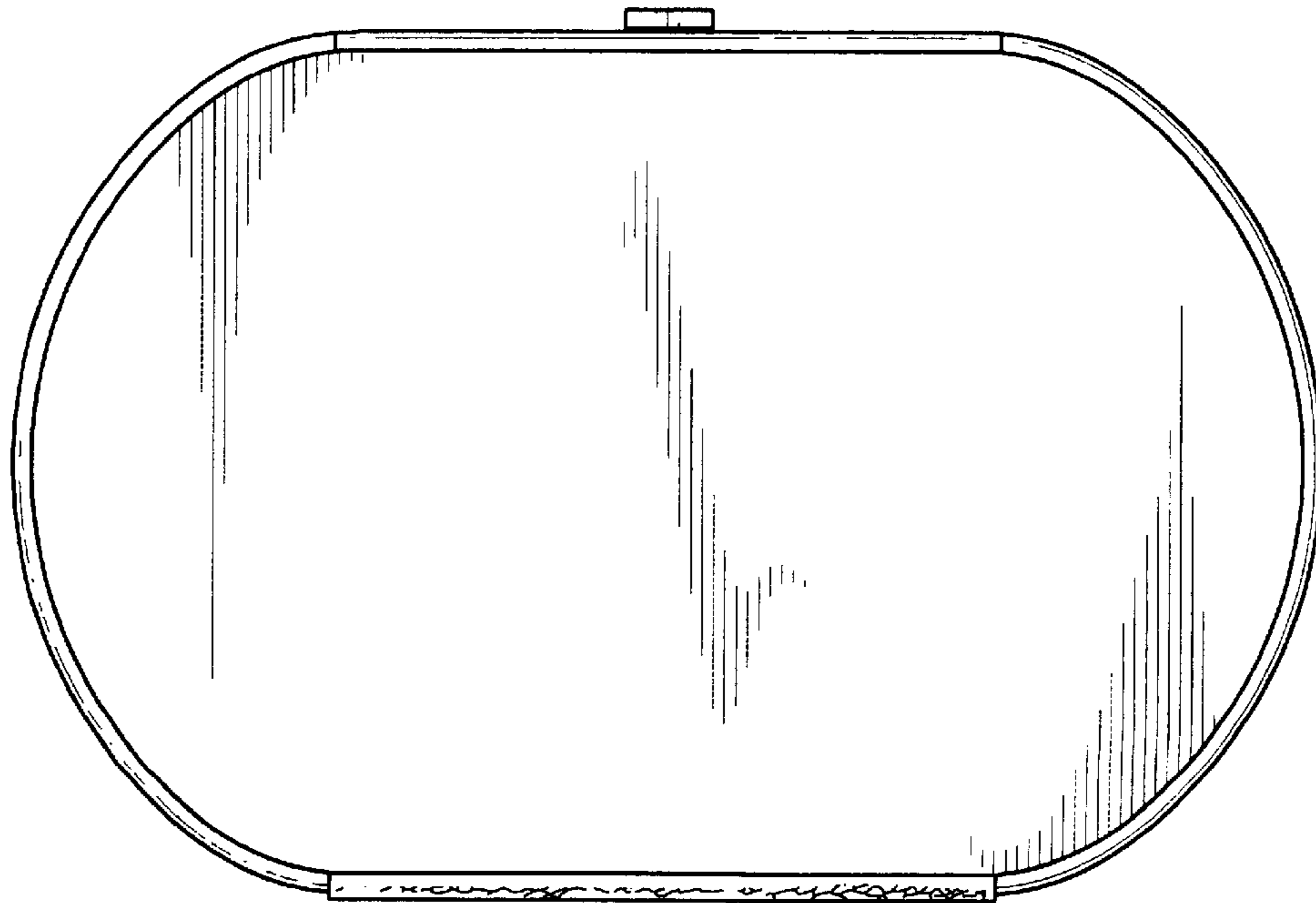

FIG. 4

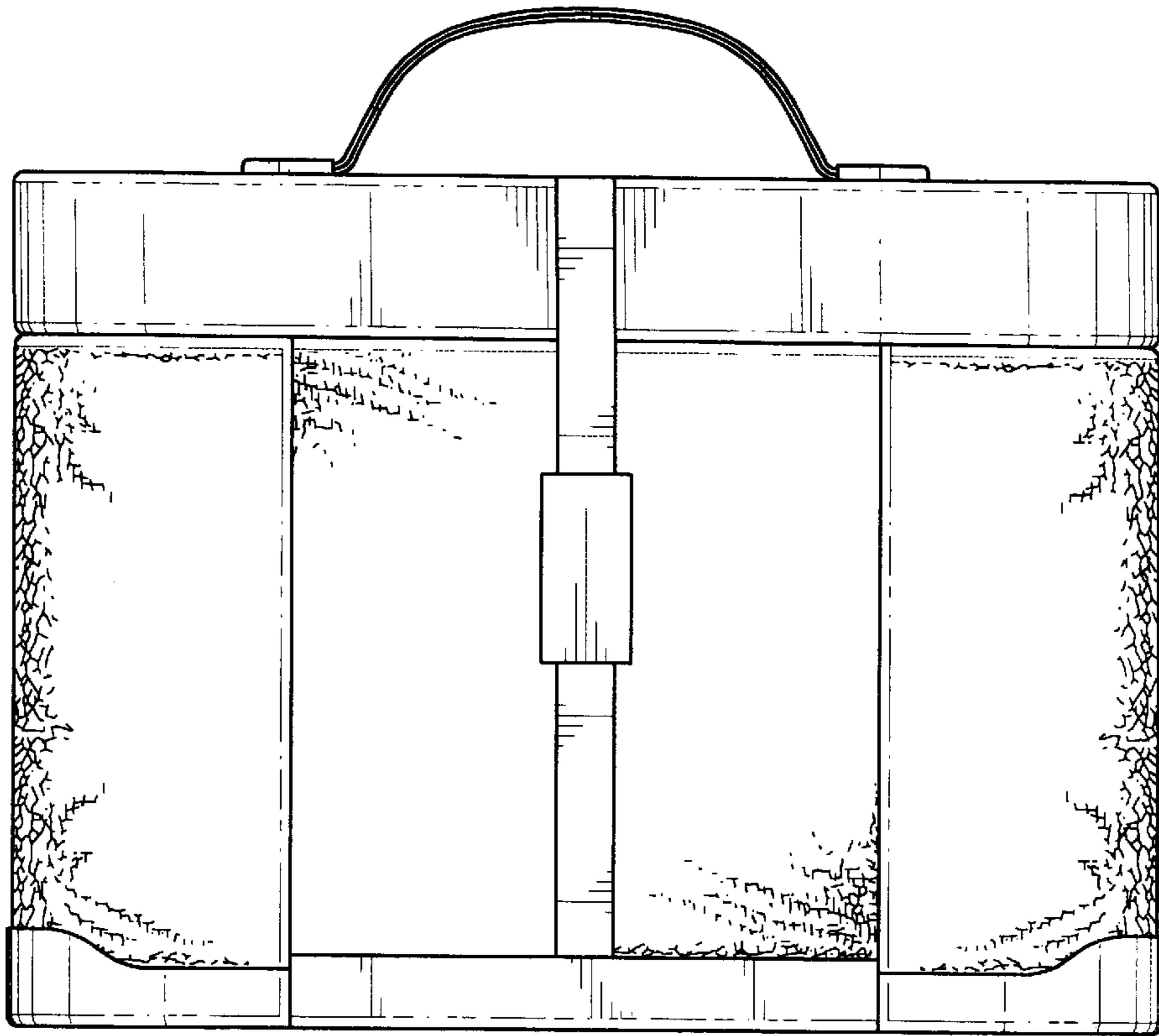

FIG. 5

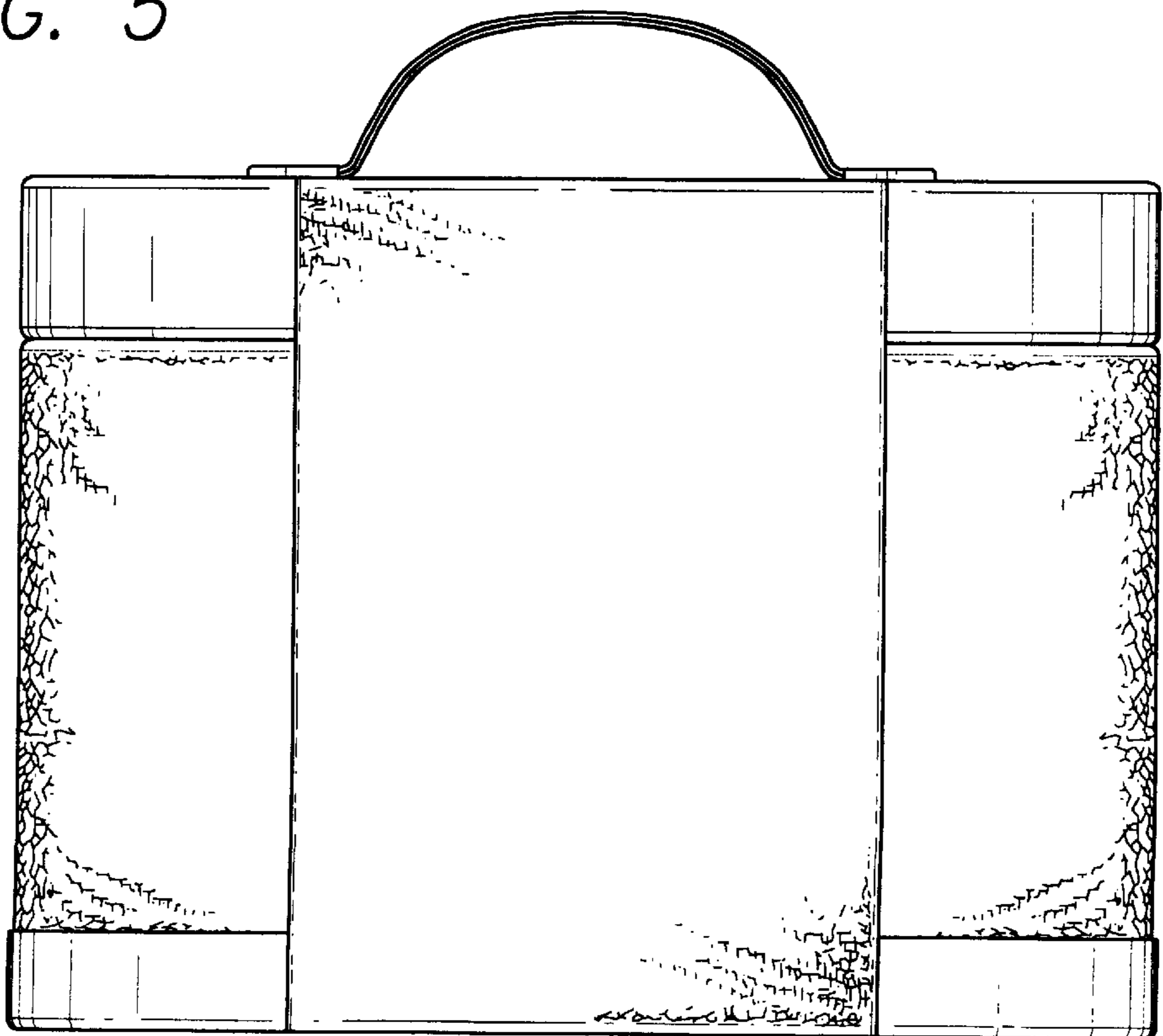
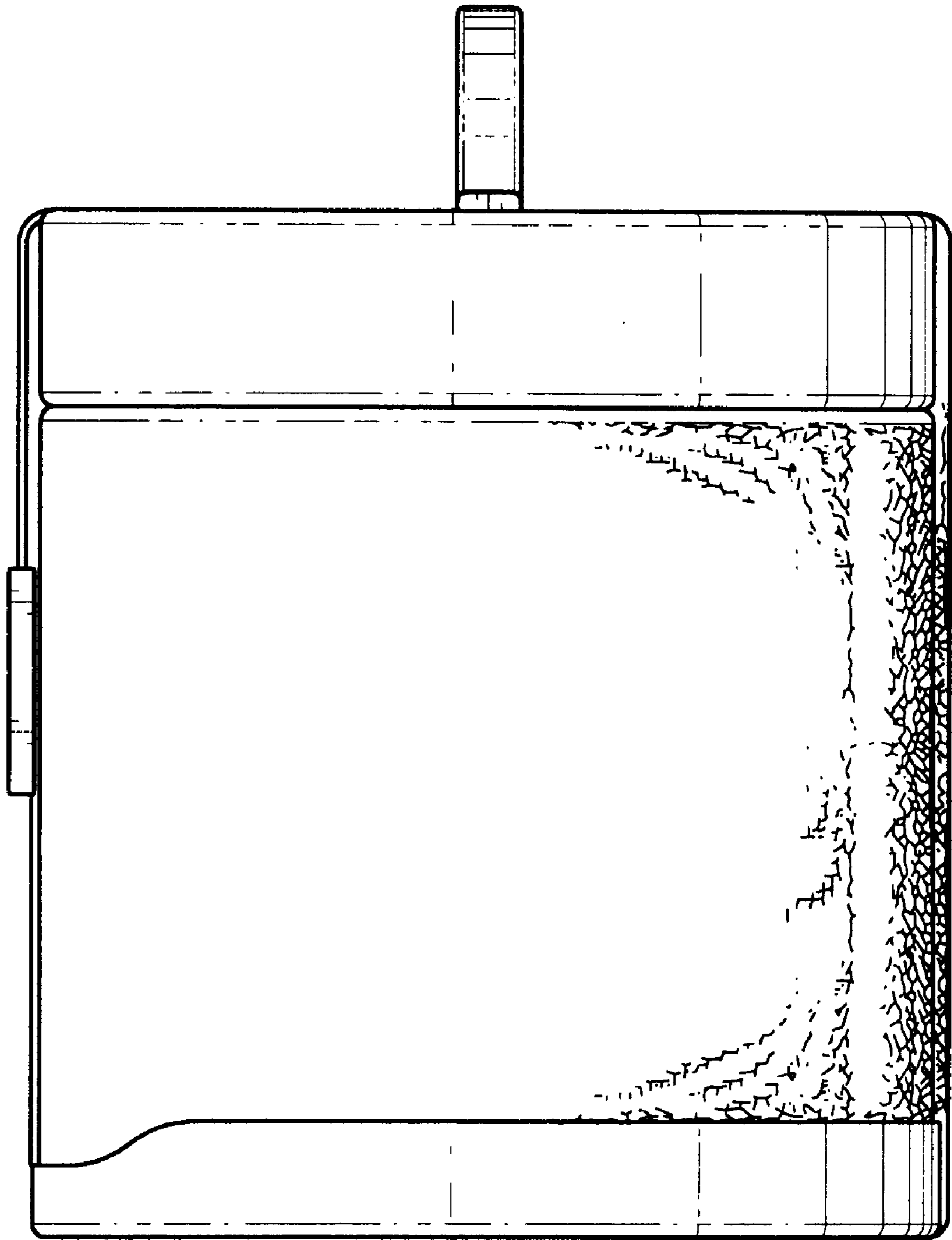

FIG. 6



*FIG. 7*