



US00D484997S

(12) **United States Design Patent**
Trygg et al.

(10) **Patent No.:** **US D484,997 S**

(45) **Date of Patent:** **** Jan. 6, 2004**

(54) **AUTOMATIC LIGHT FIXTURE**

(75) Inventors: **Kenneth I. Trygg**, Roswell, GA (US);
Alfred J. Weiss, Loudon, TN (US)

(73) Assignee: **Qualipro Industries, Inc.**, Roswell, GA (US)

(**) Term: **14 Years**

(21) Appl. No.: **29/175,696**

(22) Filed: **Feb. 6, 2003**

(51) **LOC (7) Cl.** **26-02**

(52) **U.S. Cl.** **D26/39**

(58) **Field of Search** D26/37-50; 362/157,
362/158, 171, 172, 173, 183-208; D10/114

(56) **References Cited**

U.S. PATENT DOCUMENTS

D392,403 S * 3/1998 Benensohn D26/39
D407,511 S * 3/1999 Wright et al. D26/39

* cited by examiner

Primary Examiner—Marcus A. Jackson
(74) *Attorney, Agent, or Firm*—Hinkle & O’Bradovich, LLC

(57) **CLAIM**

The ornamental design for an automatic light fixture, as shown and described.

DESCRIPTION

FIG. 1 is an overall front perspective view of the automatic light fixture showing my new design;
FIG. 2 is an overall perspective view of the automatic light fixture mounted on the door of a mailbox;
FIG. 3 is a top plan view;
FIG. 4 is a front elevation view;
FIG. 5 is a right side elevation view;
FIG. 6 is a left side elevation view,
FIG. 7 is a bottom plan view; and,
FIG. 8 is a rear elevation view.

The broken lines in FIG. 2 are for environmental purposes only and form no part of the invention.

1 Claim, 3 Drawing Sheets

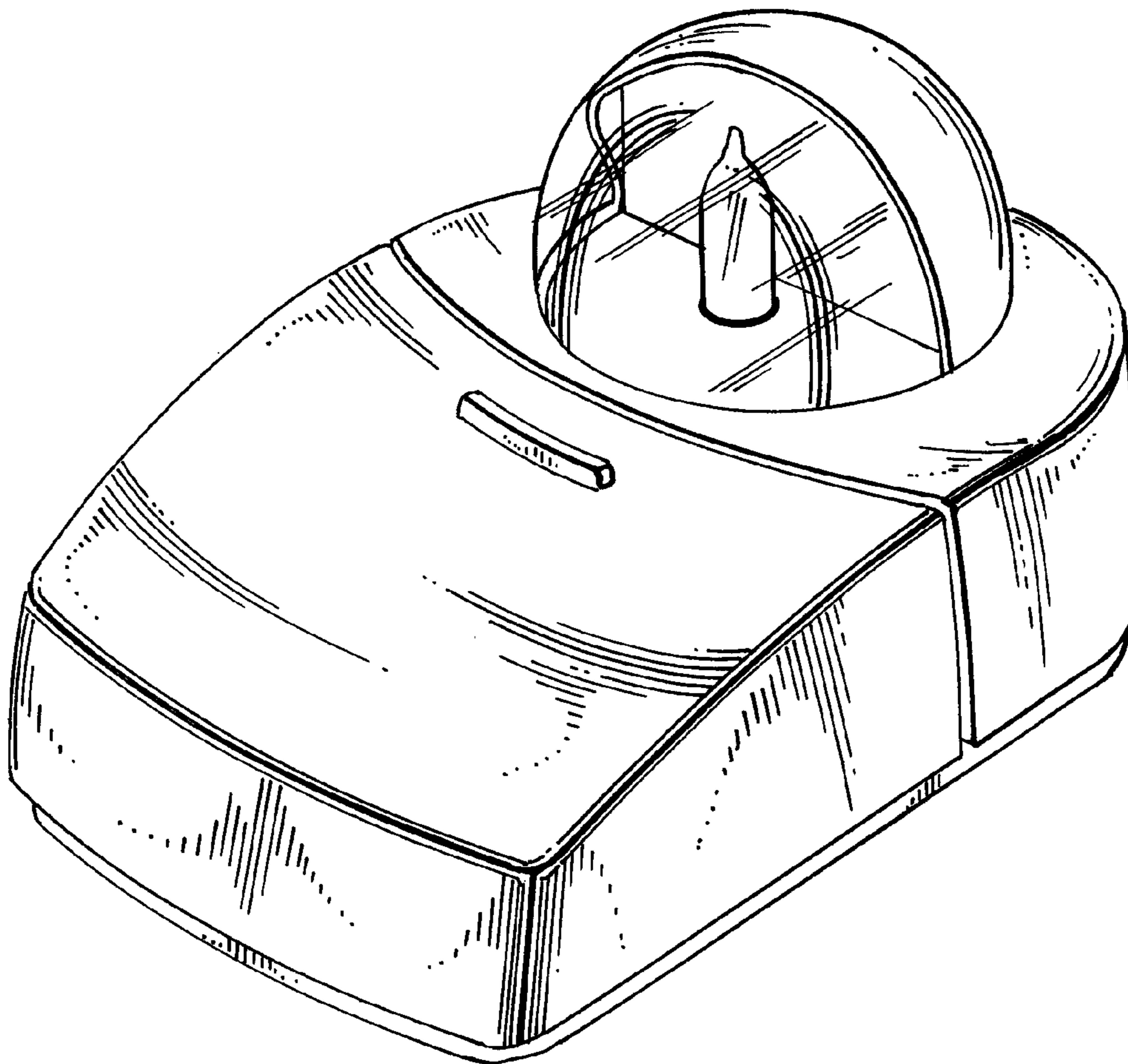

Fig. 1

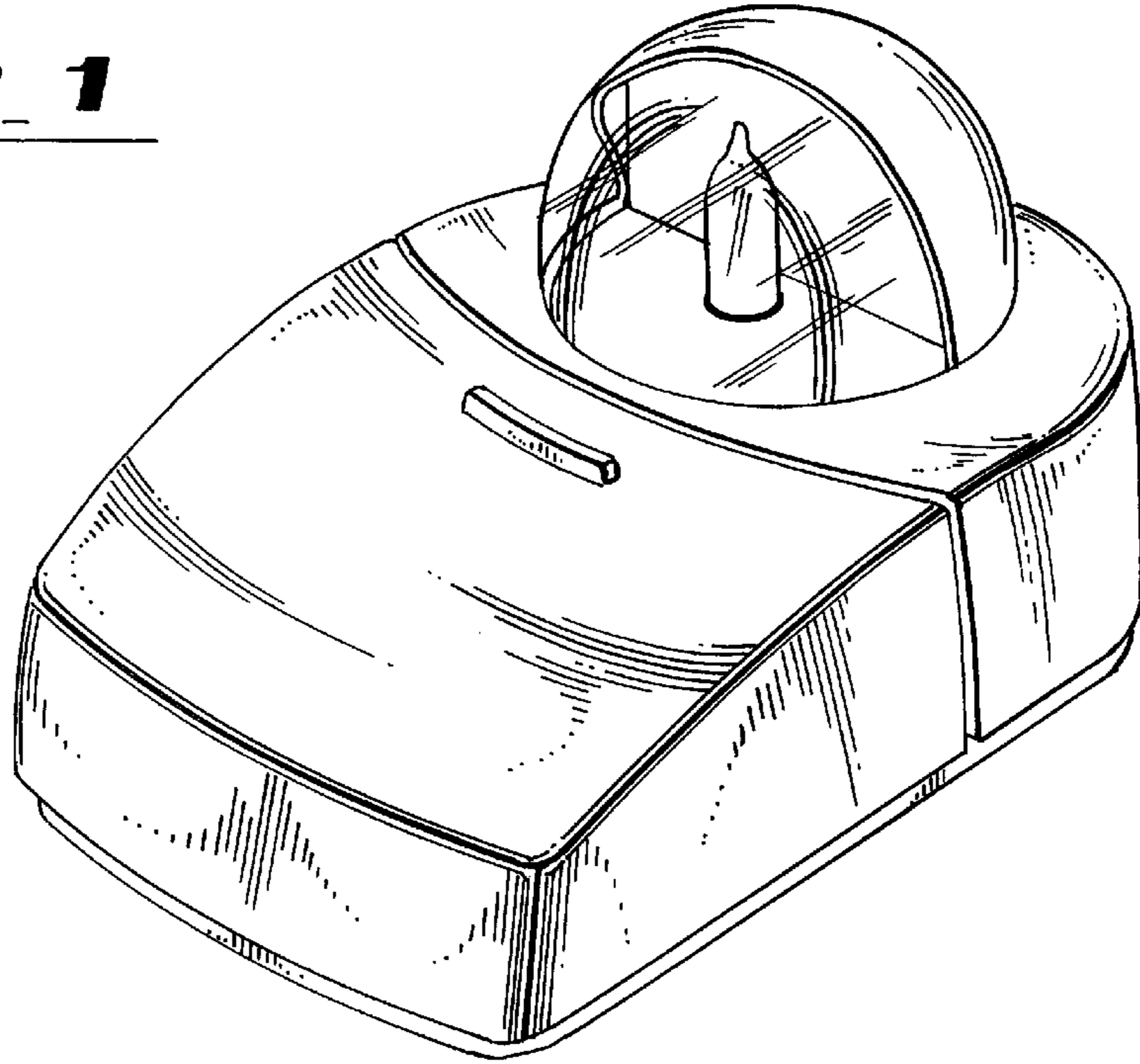

Fig. 2

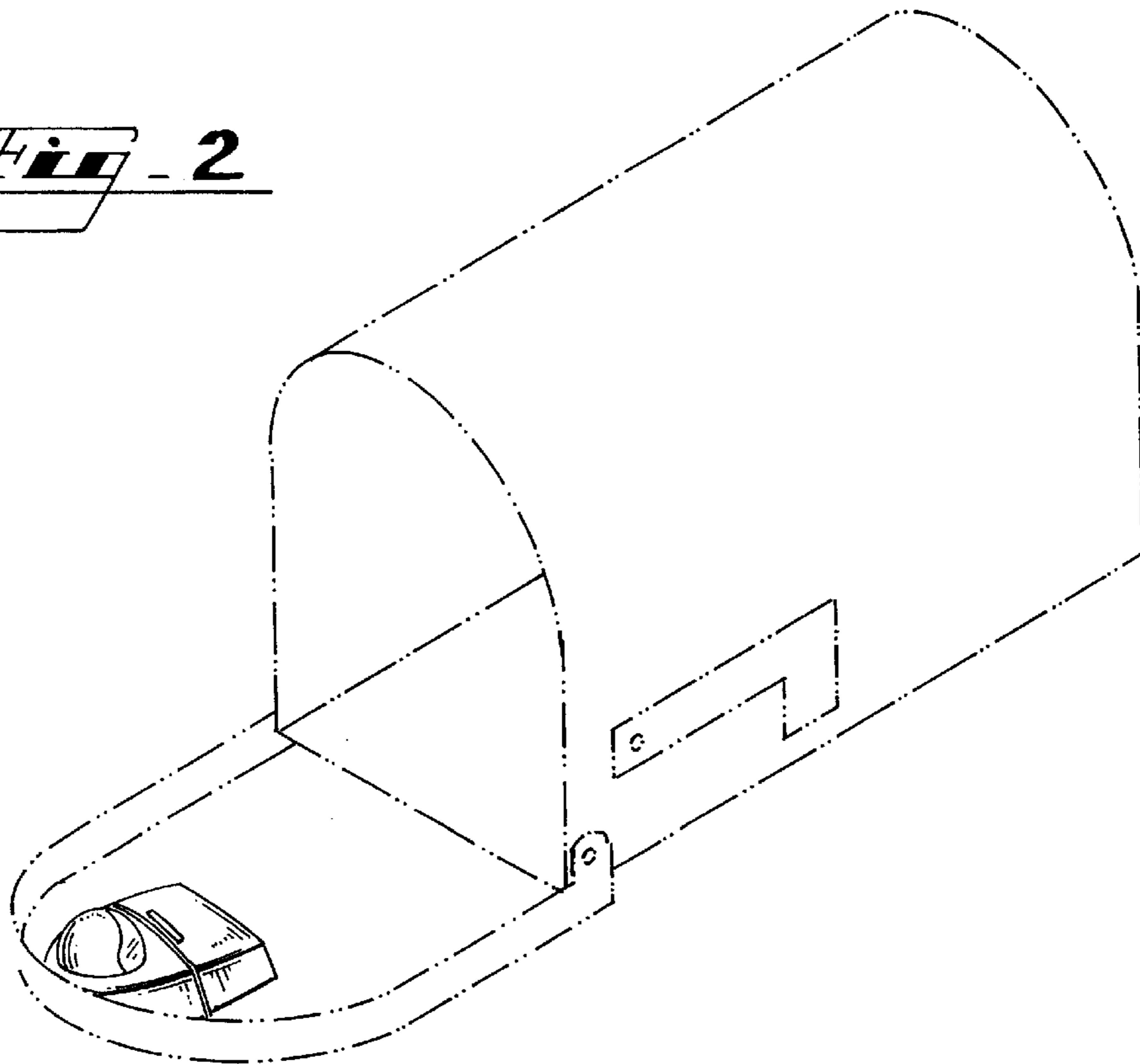

Fig. 3

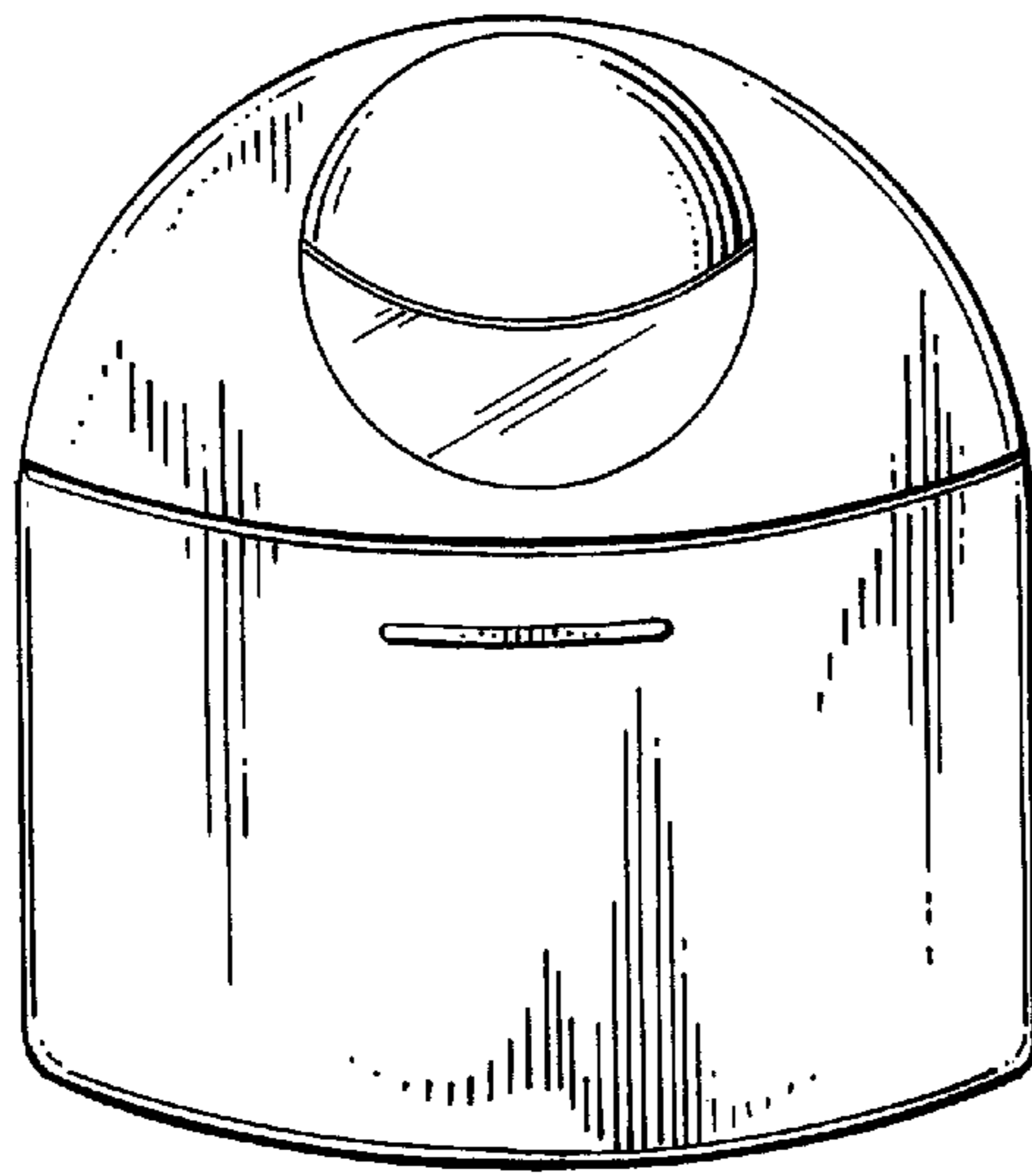

Fig. 5

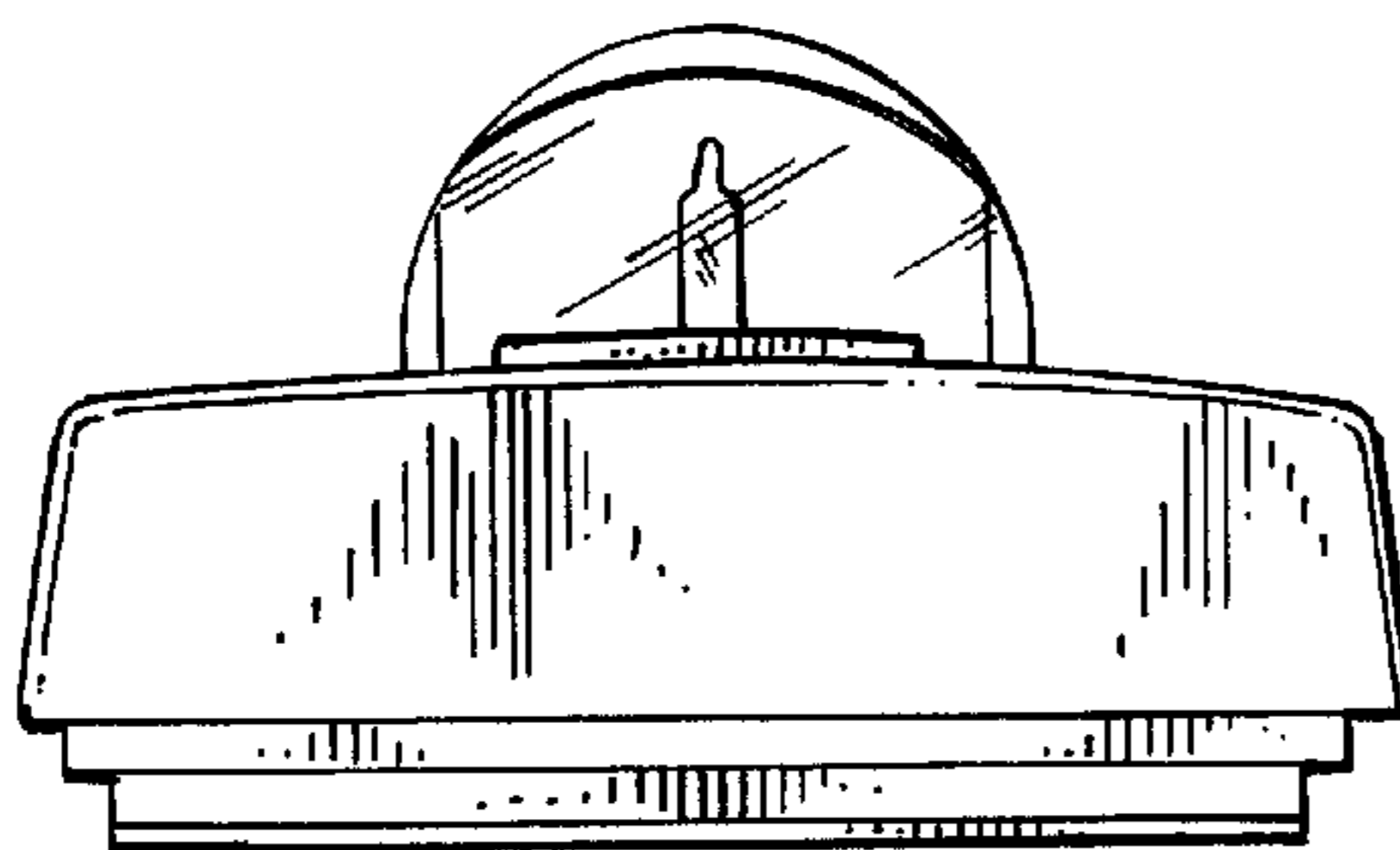
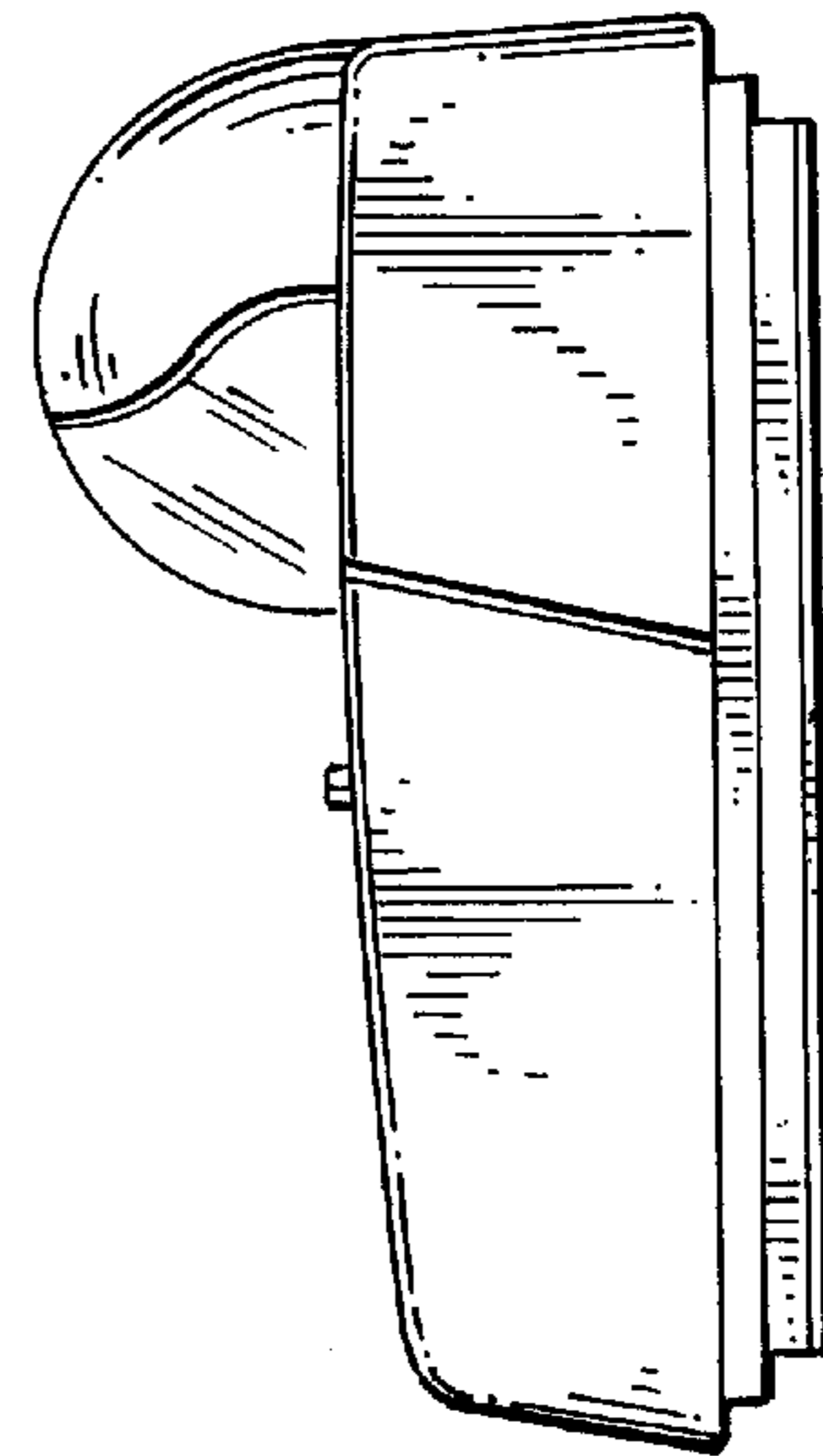

Fig. 4

Fig. 7

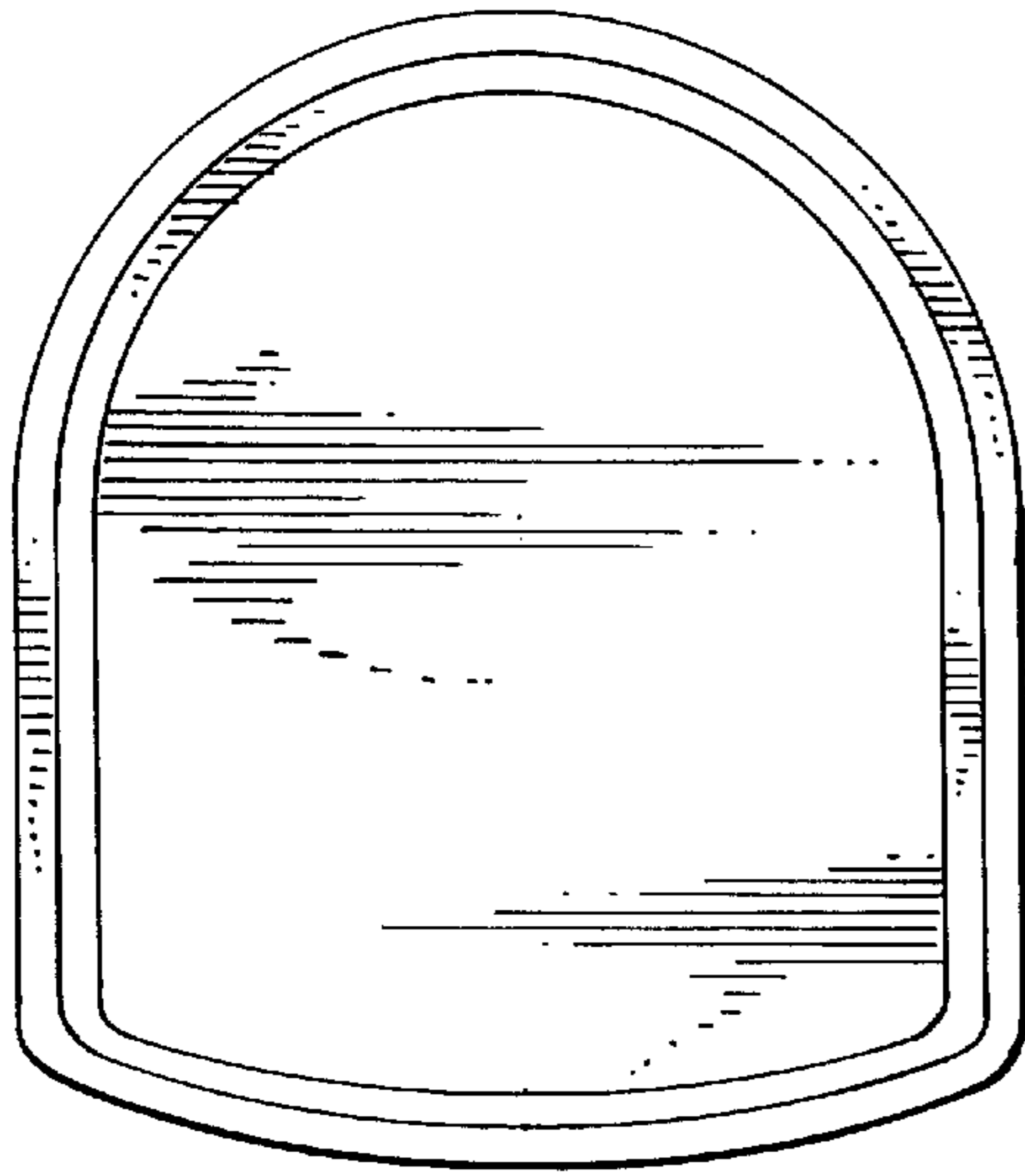

Fig. 6

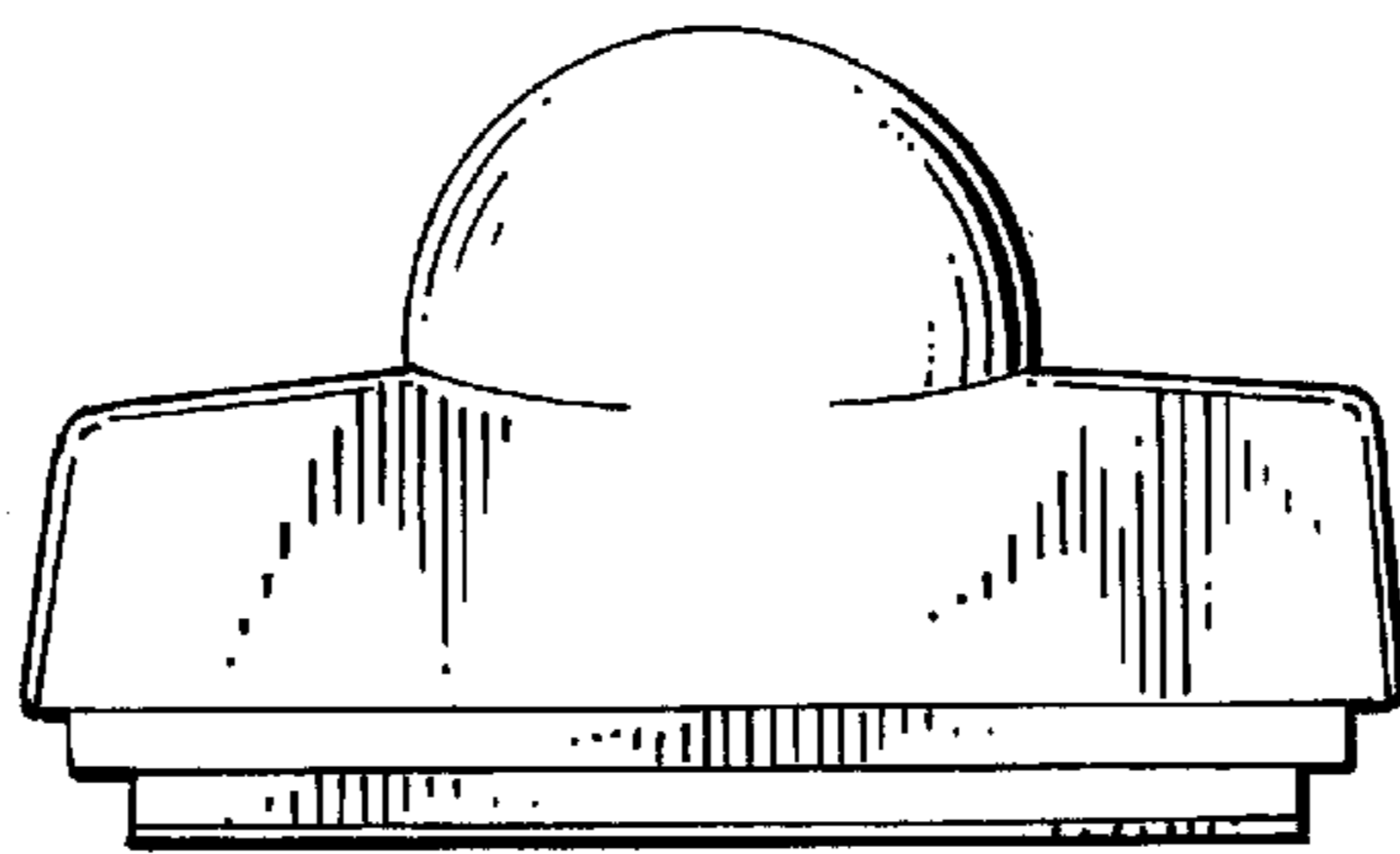
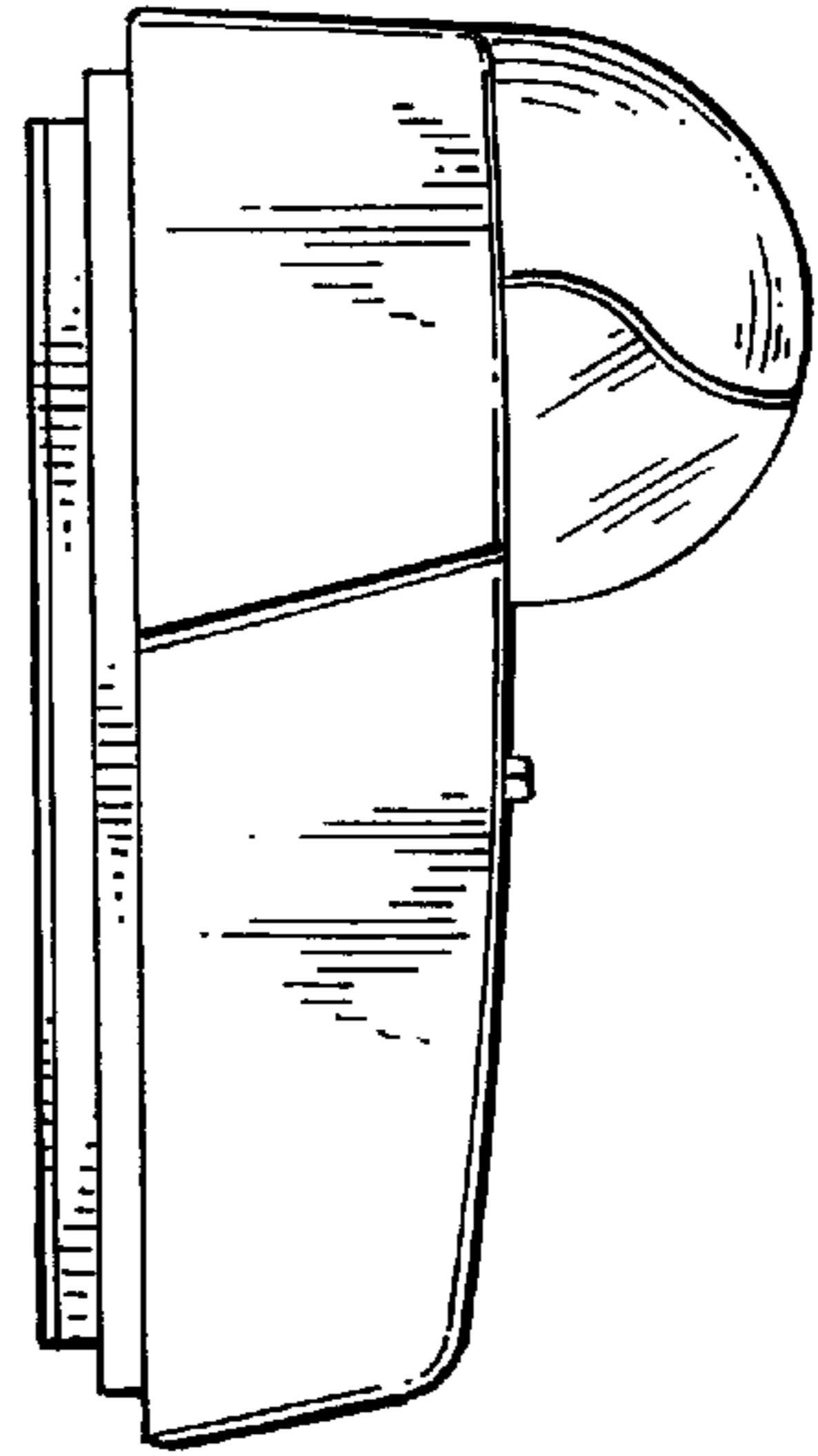

Fig. 8