



US00D484988S

(12) **United States Design Patent**
Peterson et al.

(10) **Patent No.:** **US D484,988 S**

(45) **Date of Patent:** **** *Jan. 6, 2004**

(54) **DIAGNOSTIC TEST KIT WITH SPECIMEN-HANDLING TOOL**

WO	94/22380	10/1994
WO	98/54563	12/1998
WO	99/02101	1/1999
WO	99/25251	5/1999
WO	99/51769	10/1999
WO	99/61892	12/1999

(75) Inventors: **Kristy Peterson**, Salt Lake City, UT (US); **Donald J. McMichael**, South Jordan, UT (US)

(73) Assignee: **Kimberly-Clark Worldwide, Inc.**, Neenah, WI (US)

(*) Notice: This patent is subject to a terminal disclaimer.

(**) Term: **14 Years**

(21) Appl. No.: **29/152,428**

(22) Filed: **Dec. 17, 2001**

(51) **LOC (7) Cl.** **24-02**

(52) **U.S. Cl.** **D24/216; D24/223; D24/227**

(58) **Field of Search** D24/216, 227, D24/229, 230, 226, 223, 133, 119, 146, 147; 422/58, 61, 102; 435/286.3, 286.1, 288.3, 288.4; 206/370, 570, 572, 571, 363, 364, 366, 369, 557, 558

(56) **References Cited**

U.S. PATENT DOCUMENTS

3,145,086	A	8/1964	Free et al.
3,395,082	A	7/1968	Mast

(List continued on next page.)

FOREIGN PATENT DOCUMENTS

EP	0018825	2/1985
EP	0365459	A1 4/1990
EP	0606651	A2 7/1994
EP	0721898	A1 7/1996
FR	2442268	7/1980
GB	1112251	5/1968
GB	1478742	7/1977
GB	2037811	7/1980
WO	89/09407	10/1989

OTHER PUBLICATIONS

Patent Abstracts of Japan, 58077663 A, Kyoto Daichi Kagaku:KK, May 11, 1983.

Derwent WPI, Abstract for FR 2442268A, Orion Yhtymae OY (Orin), Jul. 25, 1980.

U.S. patent application Ser. No. 09/977,555, filed Oct. 15, 2001, Marshall et al Method for The Detection Urease and Method for Using Same.

U.S. patent application Ser. No. 09/977,556, filed Oct. 15, 2001, Marshall et al System for the Detction of Urease and Method for Using Same.

(List continued on next page.)

Primary Examiner—Ian Simmons

(74) *Attorney, Agent, or Firm*—William W. Letson

(57) **CLAIM**

We claim the ornamental design for a diagnostic test kit with specimen-handling tool, as shown and described.

DESCRIPTION

FIG. 1 is an end view of the diagnostic test kit of the present invention.

FIG. 2 is a top plan view of the diagnostic test kit of the present invention.

FIG. 3 is a side elevational view of an elongated side of the diagnostic test kit of the present invention, where both elongated sides are identical.

FIG. 4 is another end view of the diagnostic test kit of the present invention.

FIG. 5 is a perspective view of the diagnostic test kit of the present invention; and,

FIG. 6 is another perspective view of the diagnostic test kit of the present invention.

1 Claim, 3 Drawing Sheets

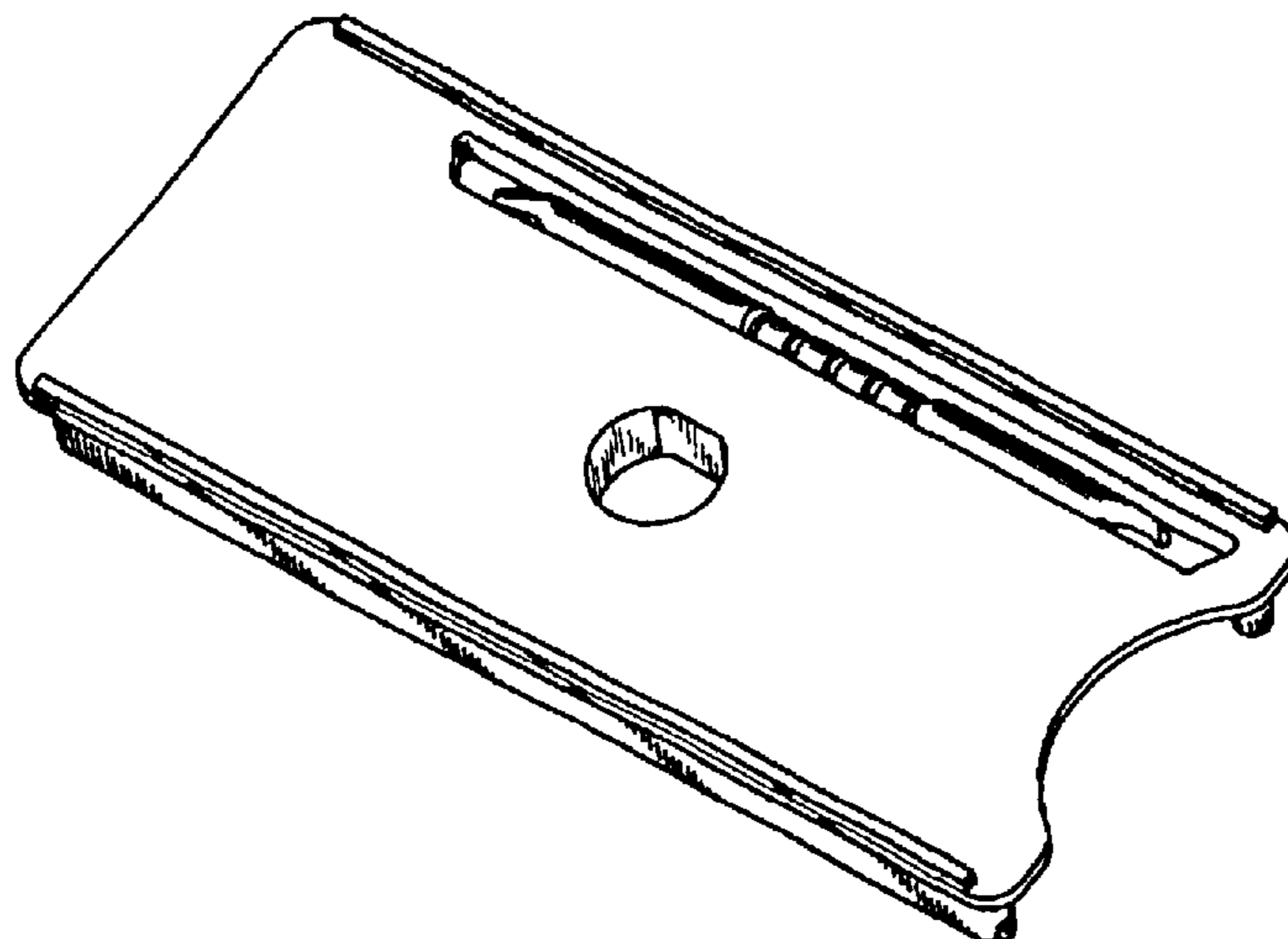

U.S. PATENT DOCUMENTS

3,411,723 A 11/1968 Kohn
 3,461,036 A 8/1969 Harvill et al.
 3,873,269 A 5/1975 Krafczyk et al.
 D241,803 S 10/1976 Amiot
 4,016,268 A 4/1977 Goldenberg et al.
 4,016,865 A 4/1977 Fredricks
 4,027,658 A 6/1977 Marshall
 4,101,382 A 7/1978 Chang
 D249,772 S 10/1978 Amiot
 4,132,502 A 1/1979 Bunke
 4,160,505 A 7/1979 Rauschenberger
 4,226,328 A 10/1980 Beddon
 4,282,316 A 8/1981 Modrovich
 4,293,074 A 10/1981 Dunsky
 D266,434 S 10/1982 Kowalski
 D271,370 S 11/1983 San Antonio
 4,620,548 A 11/1986 Hasselbrack
 D288,716 S 3/1987 Covell et al.
 4,736,850 A * 4/1988 Bowman et al. 206/570
 4,748,113 A 5/1988 Marshall
 4,777,947 A 10/1988 Zwick
 4,803,983 A 2/1989 Siegel
 D301,371 S 5/1989 Kaprelian
 4,830,010 A 5/1989 Marshall
 4,923,801 A 5/1990 Marshall et al.
 4,932,957 A 6/1990 Zwick
 4,955,971 A 9/1990 Goulter
 5,116,346 A 5/1992 Yeh
 D327,322 S 6/1992 Brewer, Jr.
 D328,347 S 7/1992 Santora
 5,149,506 A 9/1992 Skiba et al.
 D331,800 S 12/1992 Han
 5,182,191 A 1/1993 Fan et al.
 5,228,201 A 7/1993 Atkins
 5,238,651 A * 8/1993 Chuba 422/61
 5,256,684 A 10/1993 Marshall
 5,258,178 A 11/1993 Cordle et al.
 5,304,540 A 4/1994 Blackburn et al.
 5,314,804 A 5/1994 Boguslaski et al.
 5,348,023 A 9/1994 McLucas
 5,380,492 A 1/1995 Seymour
 5,420,016 A 5/1995 Boguslaski et al.
 5,431,884 A 7/1995 McDonough et al.
 5,439,801 A 8/1995 Jackson
 5,449,071 A 9/1995 Levy
 5,479,019 A 12/1995 Gross
 5,494,162 A 2/1996 Treace et al.
 5,501,597 A 3/1996 Wilson
 D368,520 S 4/1996 Brewer, Jr.
 5,593,851 A 1/1997 Jackson
 5,601,848 A 2/1997 Marshall
 5,624,554 A 4/1997 Faulkner et al.
 5,668,011 A 9/1997 Jackson
 5,682,665 A 11/1997 Svanberg
 5,702,911 A 12/1997 Whalen
 5,709,838 A 1/1998 Porter et al.
 D390,659 S 2/1998 Chan et al.
 5,722,422 A 3/1998 Palmer et al.
 D393,312 S 4/1998 Huttner
 5,738,110 A 4/1998 Beal et al.
 5,846,751 A 12/1998 Pronovost et al.
 5,854,013 A 12/1998 Ollar et al.
 D415,275 S 10/1999 Huttner
 5,989,840 A 11/1999 D'Angelo et al.
 D419,238 S 1/2000 Maissami

D420,133 S 2/2000 Huttner
 6,039,959 A 3/2000 Burnie
 D423,669 S 4/2000 Huttner et al.
 6,048,735 A 4/2000 Hessel et al.
 6,060,241 A 5/2000 Corthésy-Theulaz
 6,068,985 A 5/2000 Cripps et al.
 D428,489 S 7/2000 Huttner et al.
 D428,991 S 8/2000 Fourie et al.
 6,113,875 A 9/2000 Nyström et al.
 6,116,426 A * 9/2000 Slonim 206/570
 D435,293 S 12/2000 Tang
 6,156,346 A 12/2000 Chen et al.
 6,165,736 A 12/2000 Fawcett
 6,171,811 B1 1/2001 Becerro De Bengoa Vallejo
 6,172,215 B1 1/2001 Keshi et al.
 6,187,556 B1 2/2001 Lee et al.
 D438,979 S 3/2001 Gomes et al.
 D445,503 S 7/2001 Huttner
 D447,237 S 8/2001 Huttner et al.
 6,291,234 B1 9/2001 Raz et al.
 6,309,818 B1 * 10/2001 Malinda et al. 206/370
 D452,936 S 1/2002 Grisoni

OTHER PUBLICATIONS

U.S. patent application Ser. No. 10/026,321, filed Dec. 20, 2001, Marshall et al Gel-Based Media for Transfer Slides, Methods of Producing and Using same.
 U.S. patent application Ser. No. 09/977,874, filed Oct. 15, 2001, Marshall et al Composition for The Detection of Gastrointestinal disorders.
 U.S. patent application Ser. No. 09/977,546, filed Oct. 15, 2001, Marshall et al Systems for Performing Multiple Diagnostic Tests.
 U.S. patent application Ser. No. 09/977,539, filed Oct. 15, 2001, McMichael et al Method for Programming Multiple Diagnostic Tests.
 U.S. patent application Ser. No. 09/977,547, filed Oct. 15, 2001, Peterson et al Systems for Diagnostic Testing.
 U.S. patent application Ser. No. 29/149,654, filed Oct. 15, 2001, McMichael et al Diagnostic Test Carrier.
 U.S. patent application Ser. No. 09/977,667, filed Oct. 15, 2001, Marshall et al Specimen-Handling Tool.
 U.S. patent application Ser. No. 10/026,200, filed Dec. 21, 2001, Peterson et al Diagnostic Testing System and Method for Detecting Helicobacter Pylori.
 U.S. patent application Ser. No. 10/026,200, filed Dec. 21, 2001, Peterson et al Carrier and Specimen-Handling Tool for Use in Diagnostic Testing.
 U.S. Patent application Ser. No. 29/152,423, filed Dec. 17, 2001, Peterson et al Diagnostic Test Kit.
 U.S. Patent application Ser. No. 29/152,422, filed Dec. 17, 2001, Peterson et al Two-Well Diagnostic Test Kit with Specimen-Handling Tool.
 U.S. Patent application Ser. No. 29/152,444, filed Dec. 17, 2001, McMichael et al Specimen-Handling Tool.
 U.S. Patent application Ser. No. 29/152,429, filed Dec. 17, 2001, McMichael et al Test Kit Specimen-Handling Tool.
 U.S. Patent application Ser. No. 29/152,430, filed Dec. 17, 2001, McMichael et al Tool for Handling a Specimen.
 Abstract EP 0721898 A1, Neumeyer E S, Jul. 17, 1996.

* cited by examiner

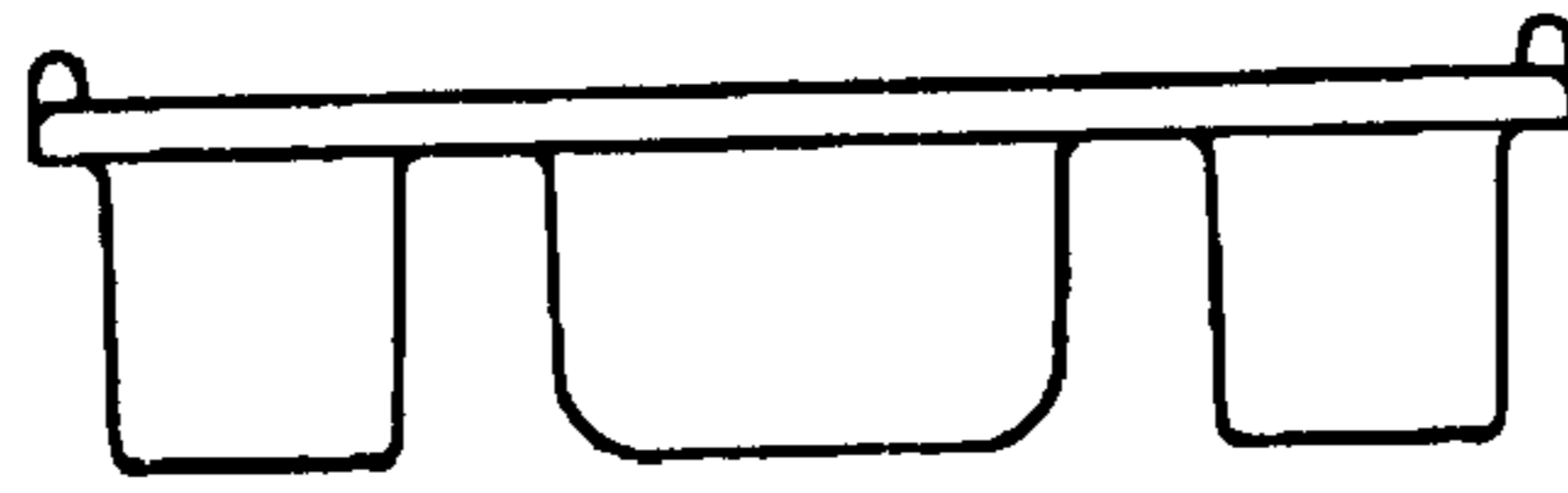

FIG. 1

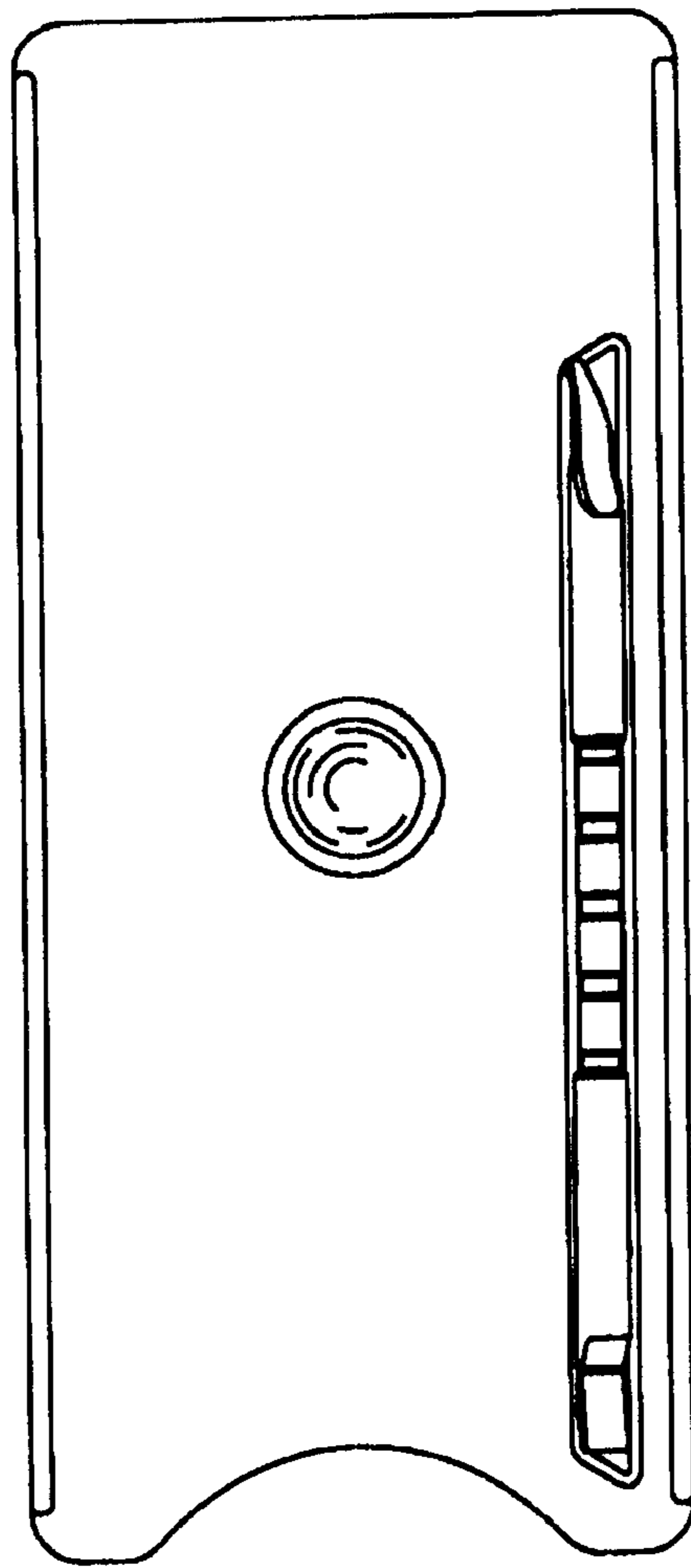

FIG. 2

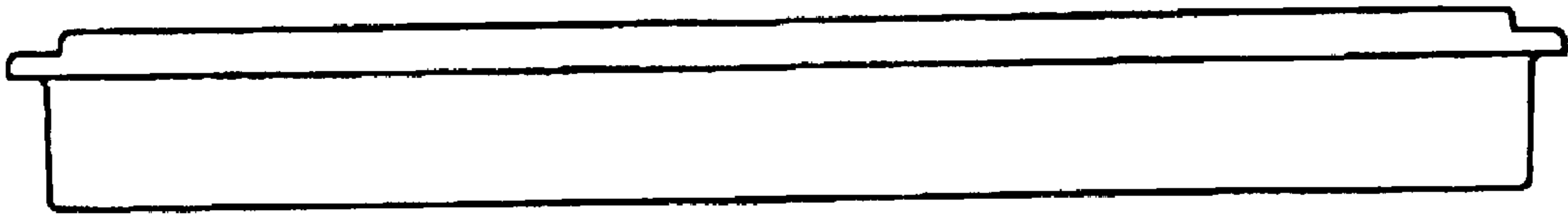

FIG. 3

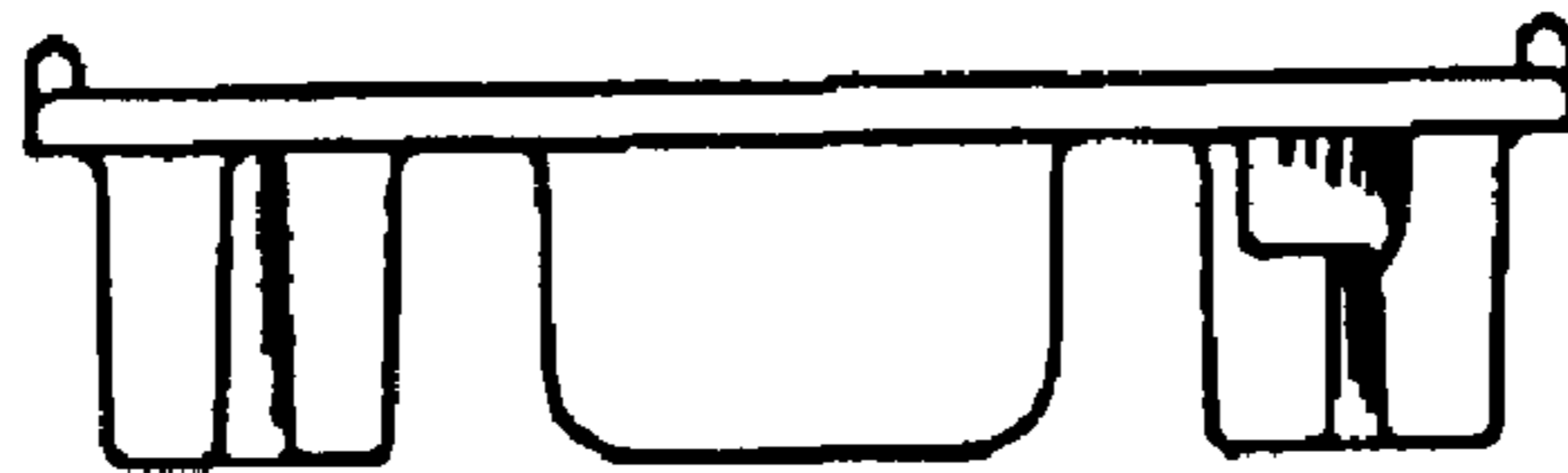

FIG. 4

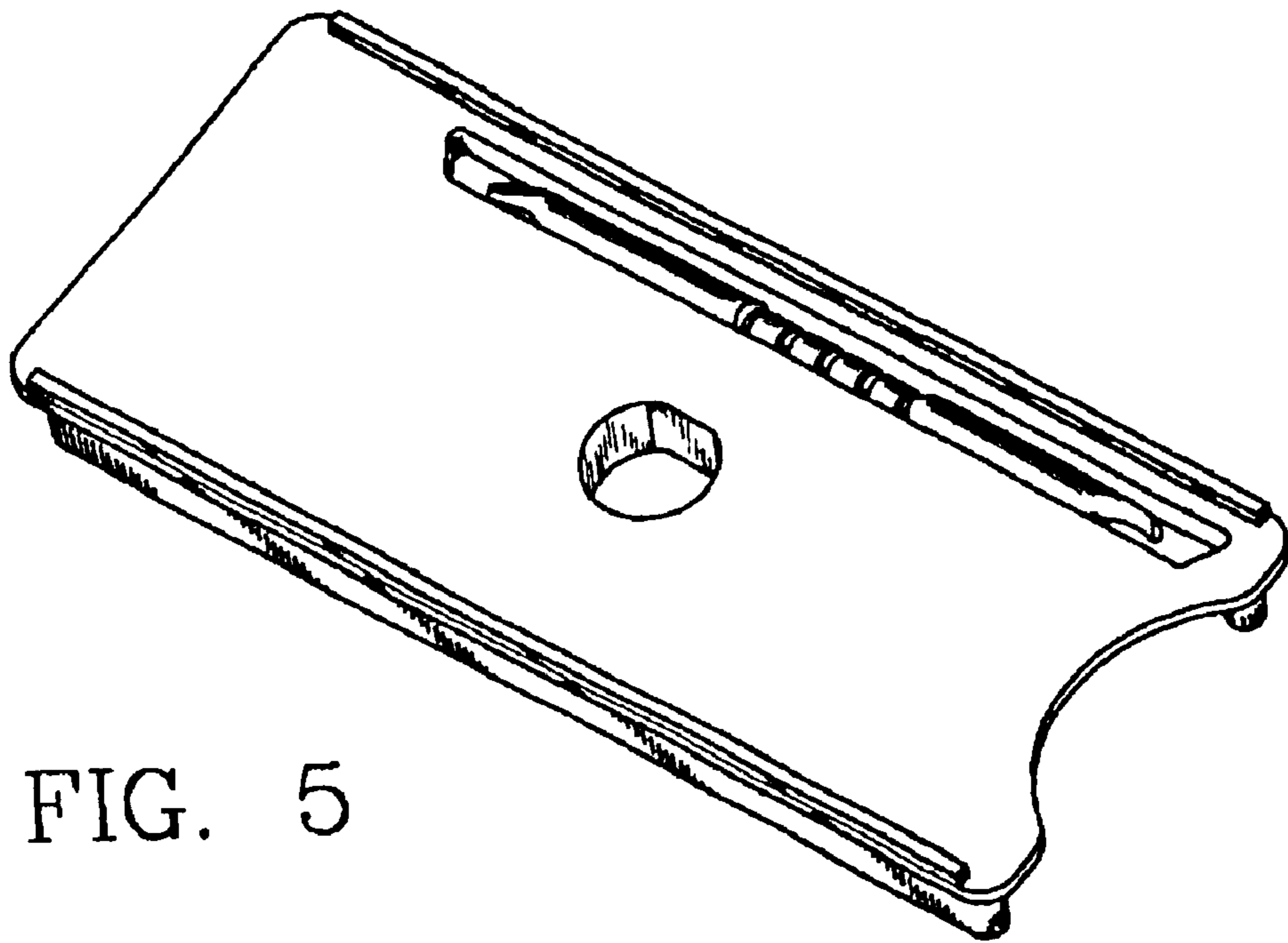

FIG. 5

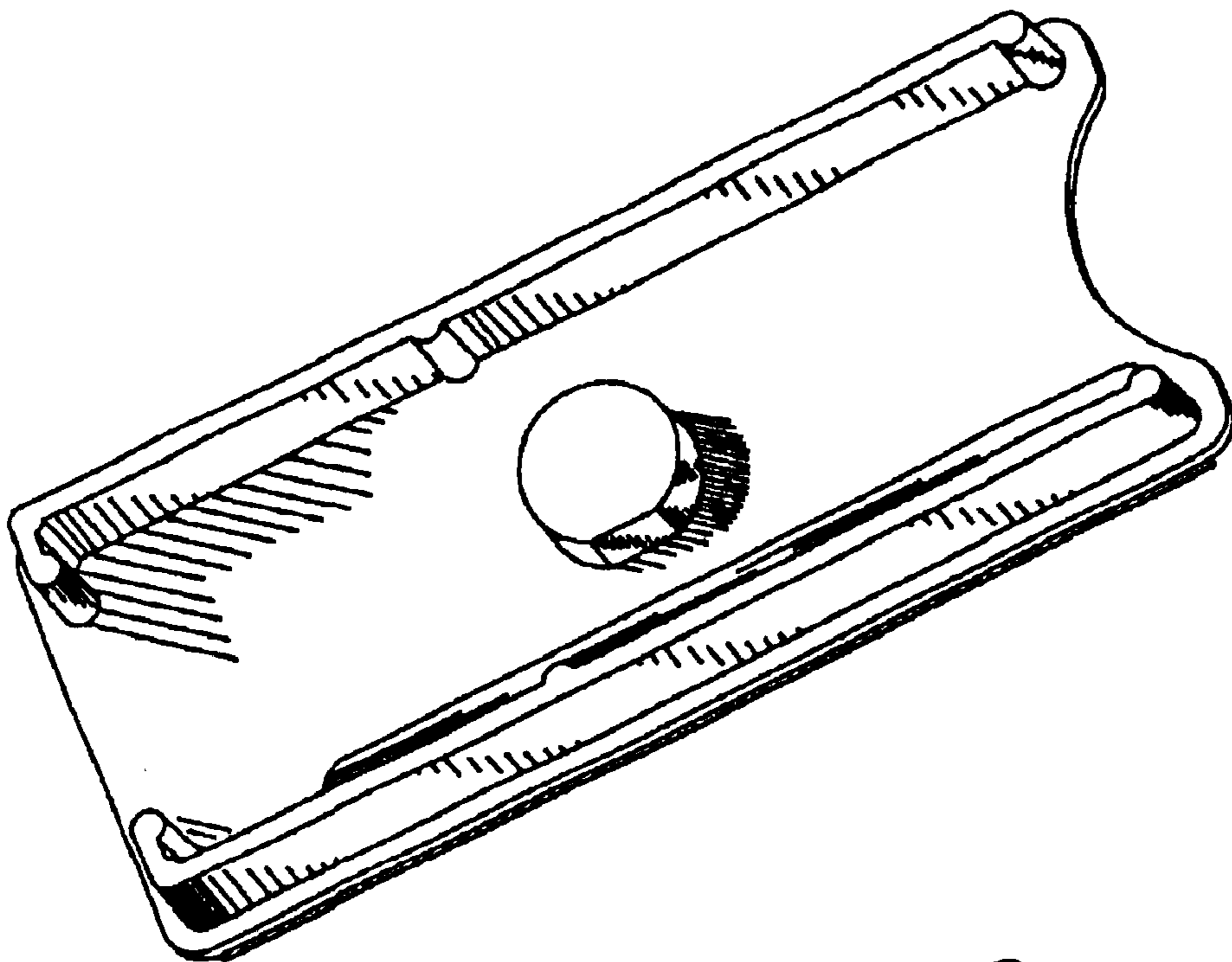

FIG. 6