



US00D484813S

(12) **United States Design Patent**
Lu

(10) **Patent No.:** **US D484,813 S**

(45) **Date of Patent:** **** Jan. 6, 2004**

(54) **LCD ELECTRONIC ALARM CLOCK WITH ZONETIME DISPLAY**

(76) **Inventor:** **Yongtai Lu**, Building 3, Siyuan Industrial Zone, Heping Village, Fuyong Town, Shenzhen, Guangdong (CN), 518103

(**) **Term:** **14 Years**

(21) **Appl. No.:** **29/178,080**

(22) **Filed:** **Mar. 20, 2003**

(30) **Foreign Application Priority Data**

Sep. 20, 2002 (HK) 0211467

(51) **LOC (7) Cl.** **10-01**

(52) **U.S. Cl.** **D10/15; D10/28**

(58) **Field of Search** D10/1-40, 122-132; 368/28-30, 41-44, 82-84, 239-242, 276-277, 280-282, 285; D14/171

(56) **References Cited**

U.S. PATENT DOCUMENTS

D67,257 S * 5/1925 Bellegay D10/2
D90,935 S * 10/1933 Barrett D10/15
D128,392 S * 7/1941 Gottlieb D10/28
D303,506 S * 9/1989 Hatakeyama D10/68

D303,933 S * 10/1989 Iacovelli D10/2
D318,019 S * 7/1991 Lelyveld D10/18
D366,215 S * 1/1996 George et al. D10/18
D375,689 S * 11/1996 Wong D10/15
D475,933 S * 6/2003 Hsu D10/18

* cited by examiner

Primary Examiner—Nelson C. Holtje

(74) *Attorney, Agent, or Firm*—Alix, Yale & Ristas, LLP

(57) **CLAIM**

The ornamental design for an LCD electronic alarm clock with zonetime display, as shown and described.

DESCRIPTION

FIG. 1 is a front view of the LCD electronic alarm clock with zonetime display showing my new design;

FIG. 2 is a rear view of the LCD electronic alarm clock with zonetime display of FIG. 1;

FIG. 3 is a left side view of the LCD electronic alarm clock with zonetime display of FIG. 1;

FIG. 4 is a right side view of the LCD electronic alarm clock with zonetime display of FIG. 1;

FIG. 5 is a top plan view of the LCD electronic alarm clock with zonetime display of FIG. 1; and,

FIG. 6 is a bottom plan view of the LCD electronic alarm clock with zonetime display of FIG. 1.

1 Claim, 3 Drawing Sheets

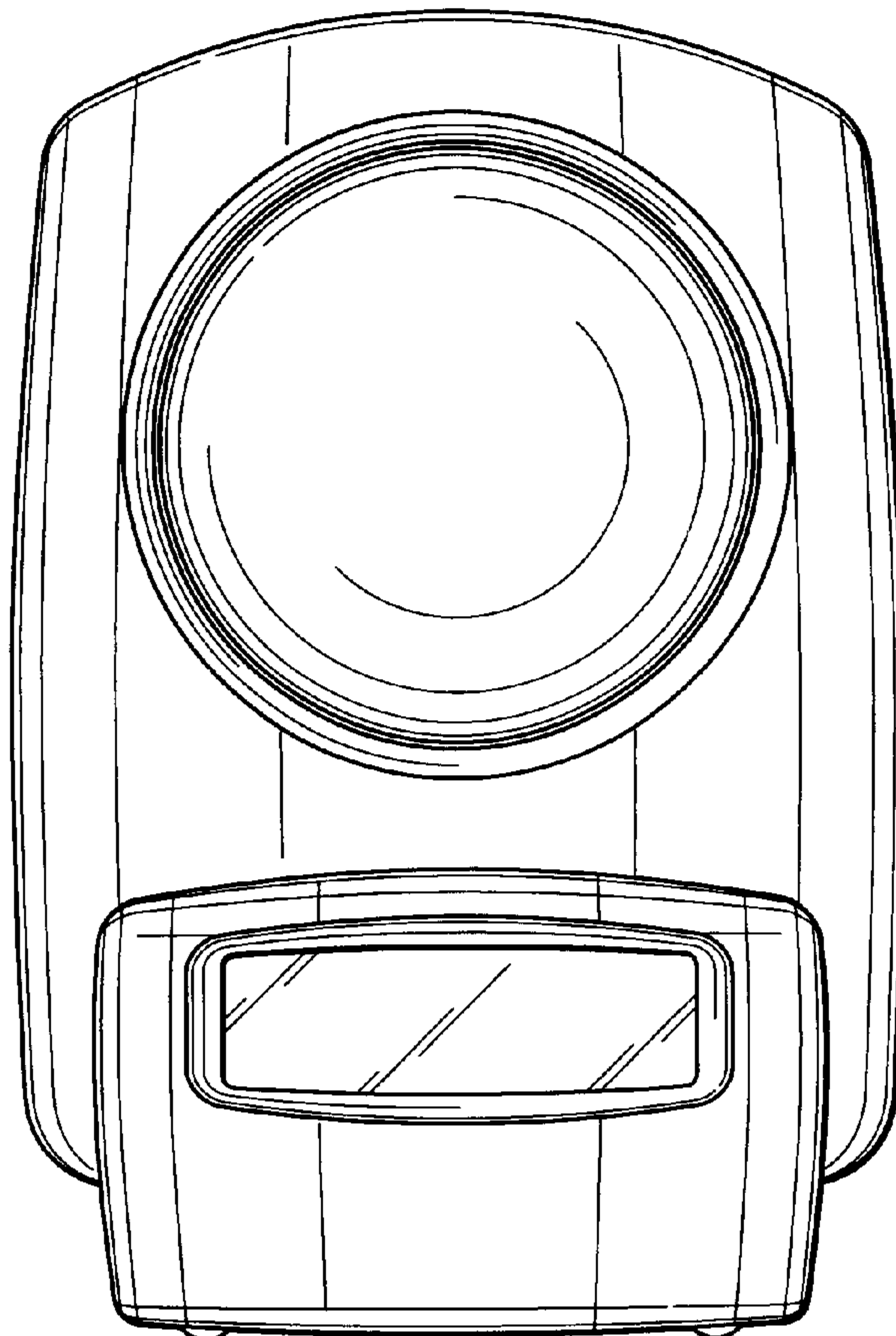

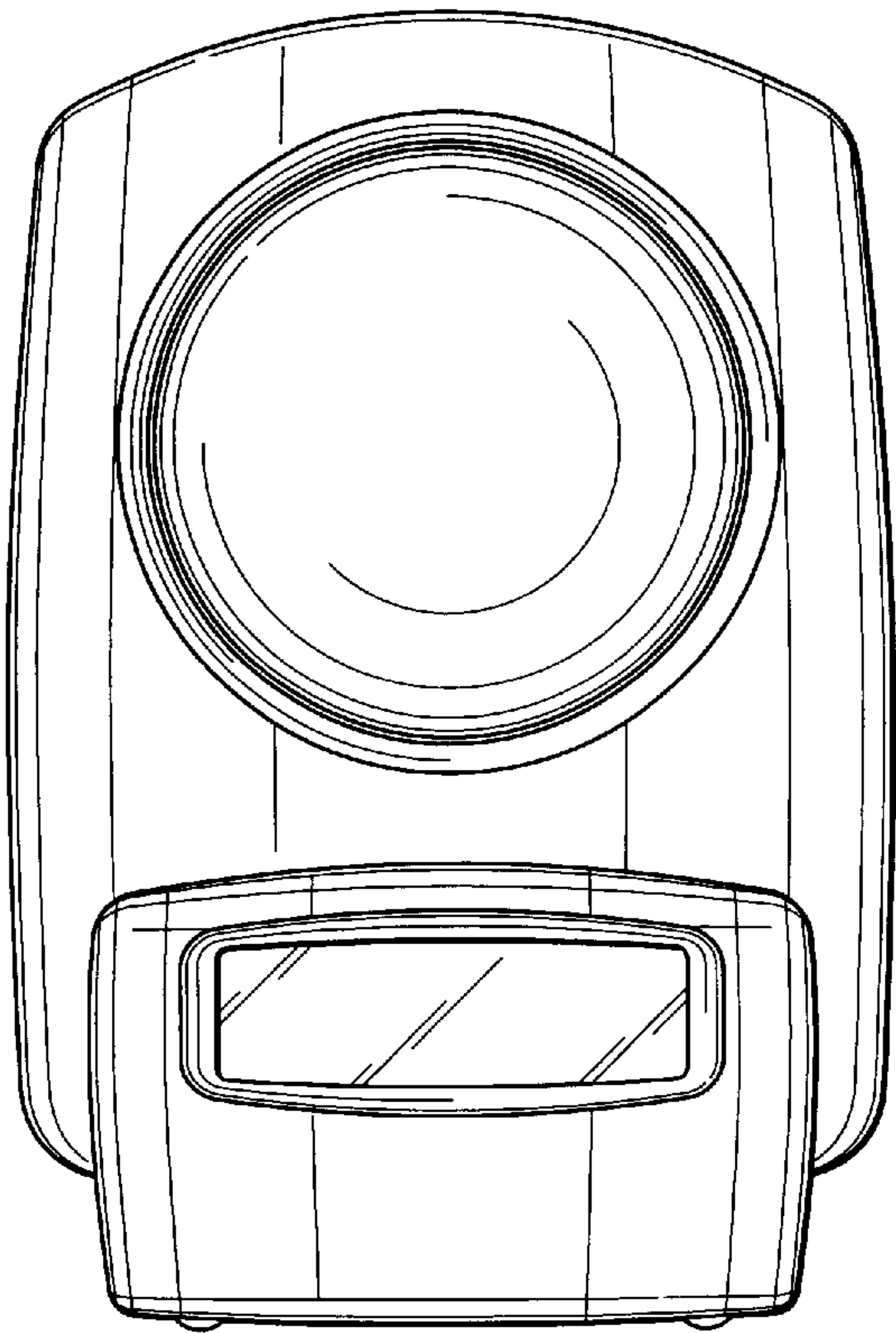

FIG. 1

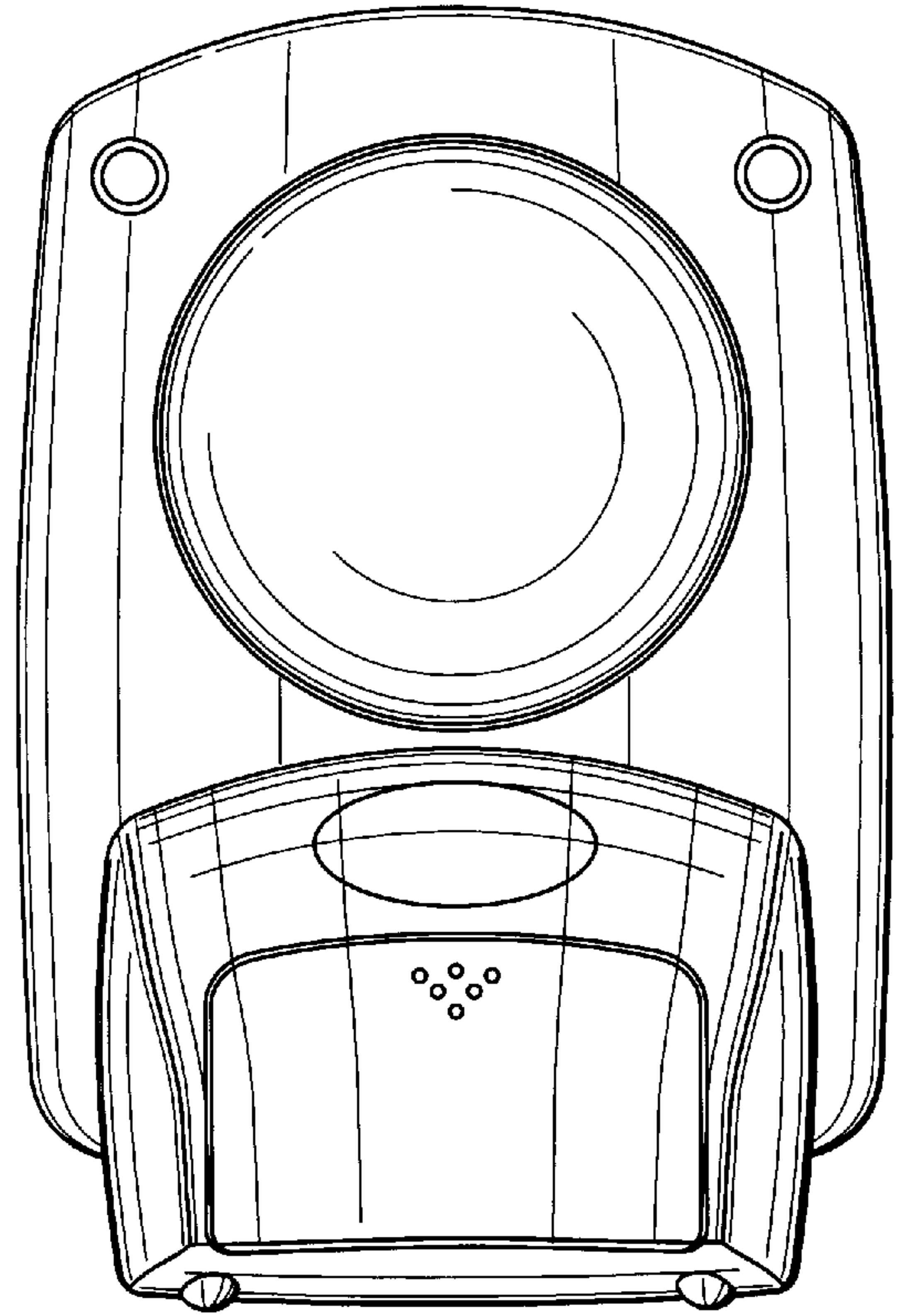

FIG. 2

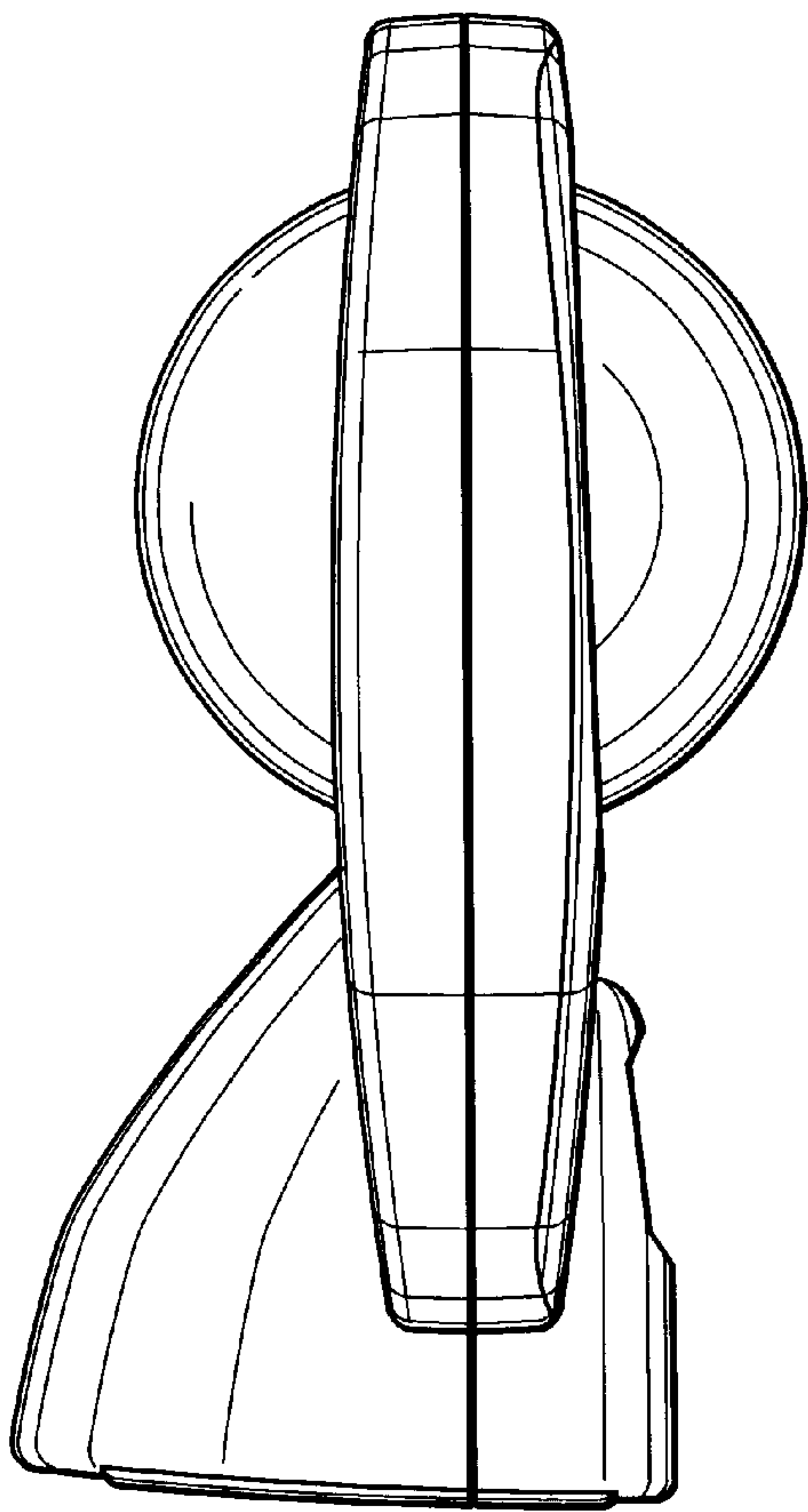

FIG. 3

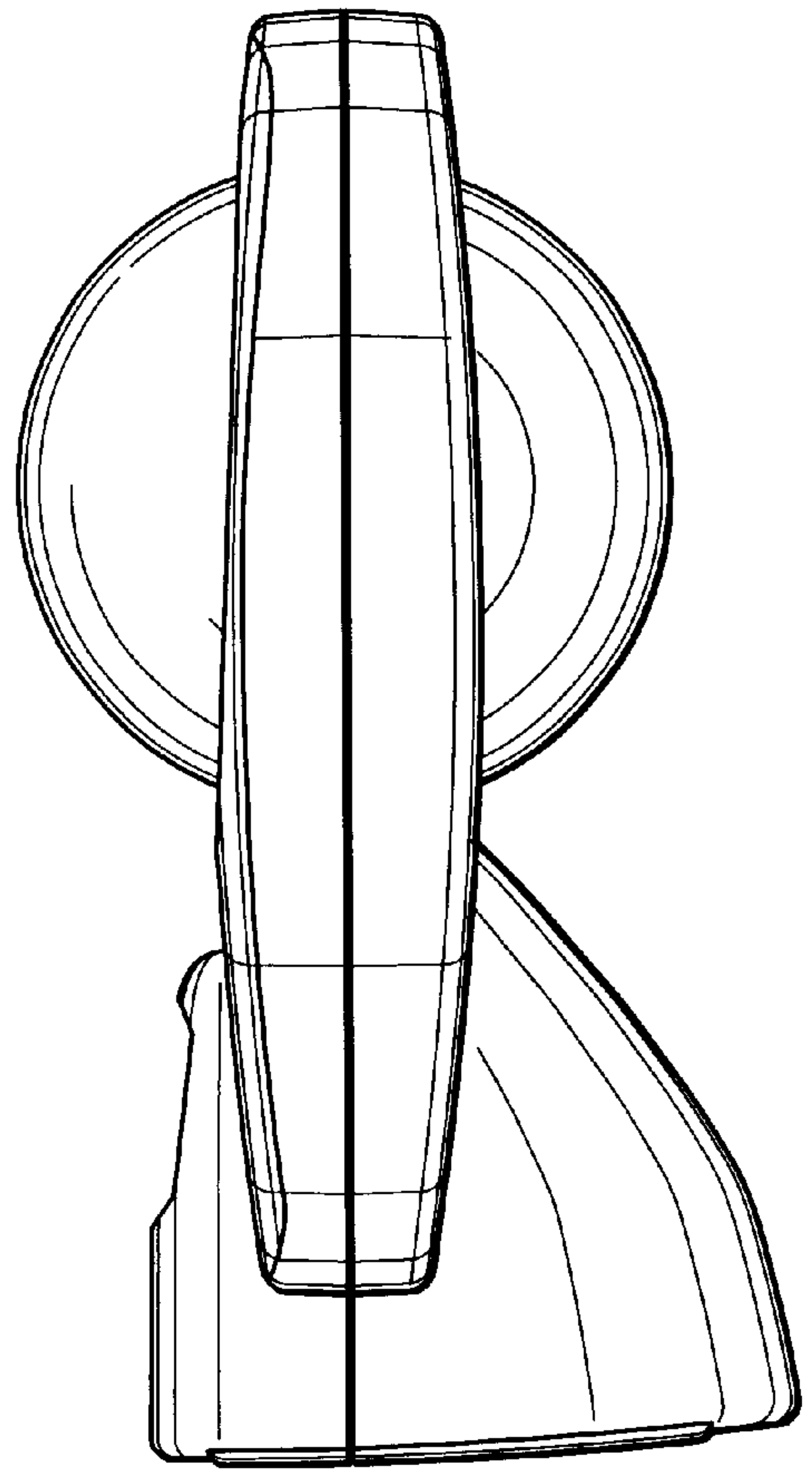

FIG. 4

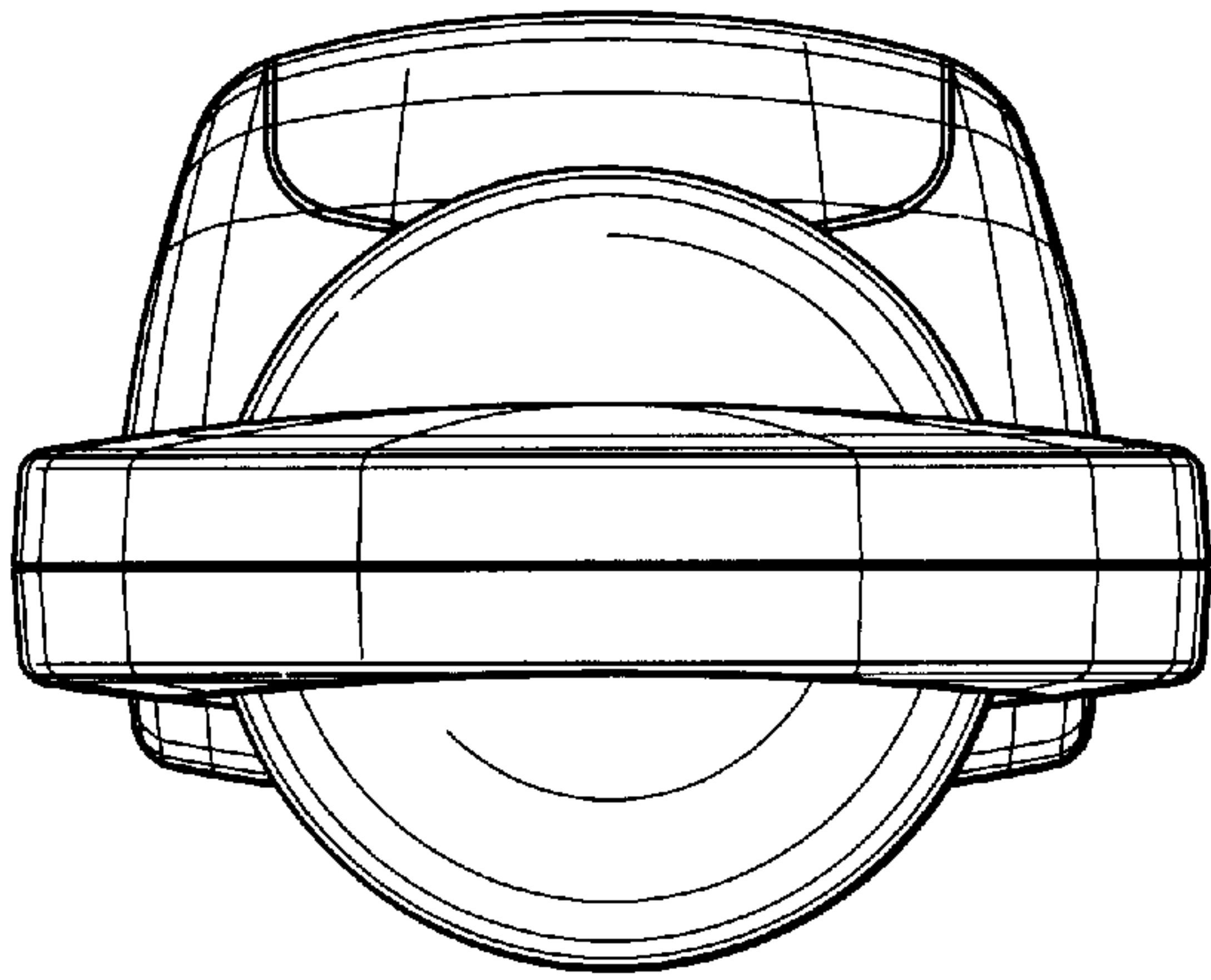

FIG. 5

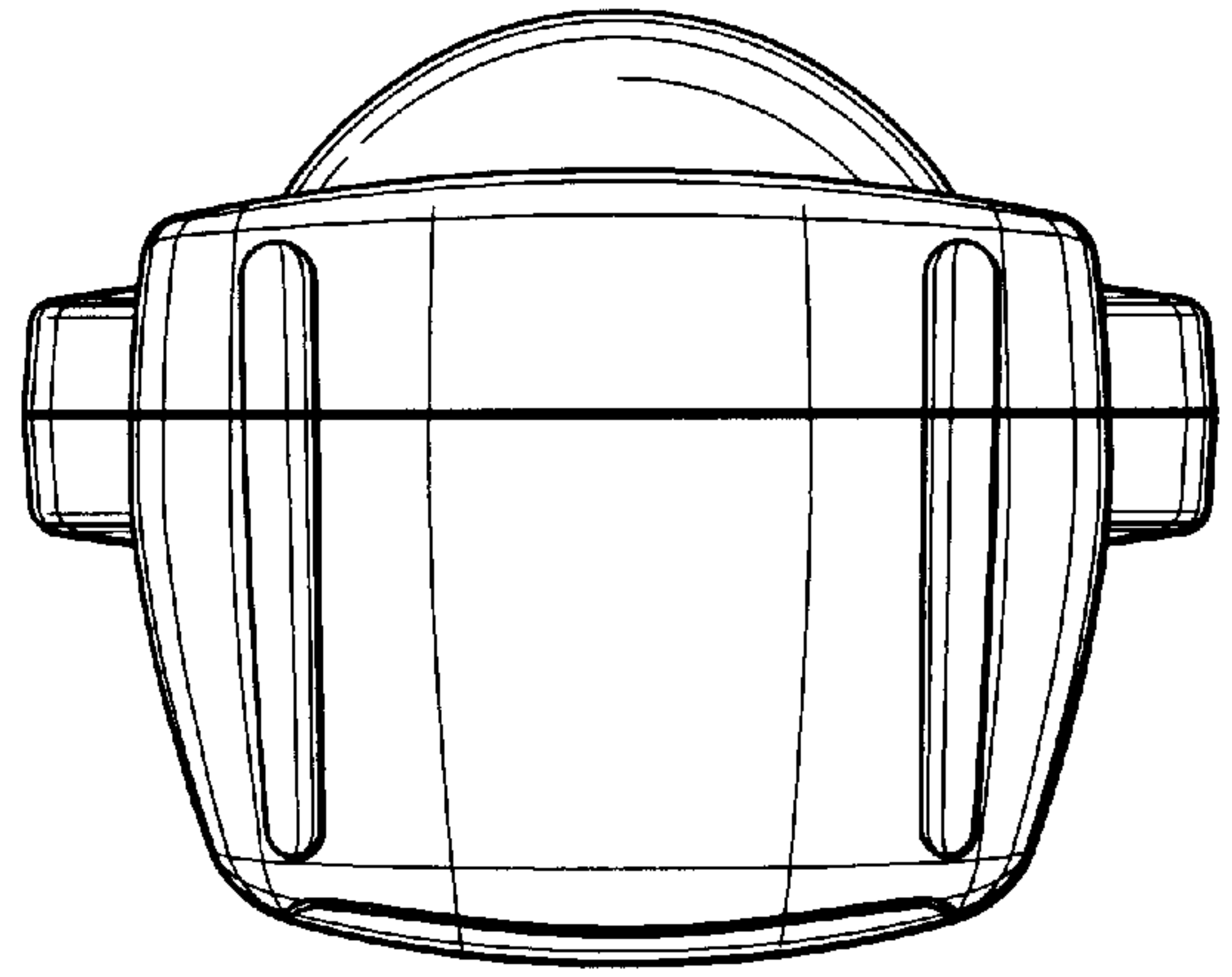

FIG. 6