



US00D484736S

(12) **United States Design Patent**
Sarnoff

(10) **Patent No.: US D484,736 S**
(45) **Date of Patent: ** Jan. 6, 2004**

(54) **FOIL ROASTER TENT**

(75) Inventor: **Norton Sarnoff**, Northbrook, IL (US)
(73) Assignee: **Handi-Foil Corporation**, Wheeling, IL (US)
(**) Term: **14 Years**

(21) Appl. No.: **29/178,395**
(22) Filed: **Mar. 25, 2003**

(51) **LOC (7) Cl.** **07-02**
(52) **U.S. Cl.** **D7/323**
(58) **Field of Search** D7/323, 324, 354,
D7/359, 629; 126/681, 682; 220/743, 573.1,
491, 647, 318; D9/424, 428; D12/401,
190; 5/420; D6/582, 583

(56) **References Cited**

U.S. PATENT DOCUMENTS

313,092	A	*	3/1885	Mayes	D7/354
D211,272	S	*	6/1968	Stageberg	D7/354
D214,460	S	*	6/1969	Stageberg	D7/354
D372,628	S	*	8/1996	Wareham	D7/324
5,878,656	A	*	3/1999	Fletcher et al.	99/340
5,970,856	A	*	10/1999	Fabrikant et al.	99/426
D418,354	S	*	1/2000	O'Rourke	D6/583
6,237,803	B1	*	5/2001	Sarnoff et al.	220/743
6,568,005	B2	*	5/2003	Fleming et al.	5/420

* cited by examiner

Primary Examiner—Catherine R. Oliver
(74) *Attorney, Agent, or Firm*—Adam K Sacharoff; Much Shelist

(57) **CLAIM**

The ornamental design for a foil roaster tent, substantially as shown and described.

DESCRIPTION

FIG. 1 is a top perspective view of a folded foil roaster tent showing my new design;

FIG. 2 is a front view of the foil roaster tent of FIG. 1;
FIG. 3 is a rear view of the foil roaster tent of FIG. 1;
FIG. 4 is a left side view of the foil roaster tent of FIG. 1 with the right side plan view being a mirror image thereof;
FIG. 5 is a top plan view of the foil roaster tent FIG. 1;
FIG. 6 is a bottom plan view of the foil roaster tent of FIG. 1;
FIG. 7 is a top perspective view of the unfolded open foil roaster tent of FIG. 1;
FIG. 8 is a front view of the foil roaster tent of FIG. 7 with the rear plan view being a mirror image thereof;
FIG. 9 is a right side view of the foil roaster tent of FIG. 7 with the left side plan view being a mirror image thereof;
FIG. 10 is a top plan view of the foil roaster tent FIG. 7;
FIG. 11 is a bottom plan view of the foil roaster tent of FIG. 7;
FIG. 12 is a top perspective view of the in use foil roaster tent of FIG. 1;
FIG. 13 is a top plan view of the foil roaster tent FIG. 12;
FIG. 14 is a front view of the foil roaster tent of FIG. 12 with the rear plan view being a mirror image thereof;
FIG. 15 is a right side view of the foil roaster tent of FIG. 12 with the left side plan view being a mirror image thereof; and,
FIG. 16 is a bottom plan view of the foil roaster tent of FIG. 12.

The broken line showing of environment in the drawings is for illustrative purposes only and forms no part of the claimed design.

1 Claim, 6 Drawing Sheets

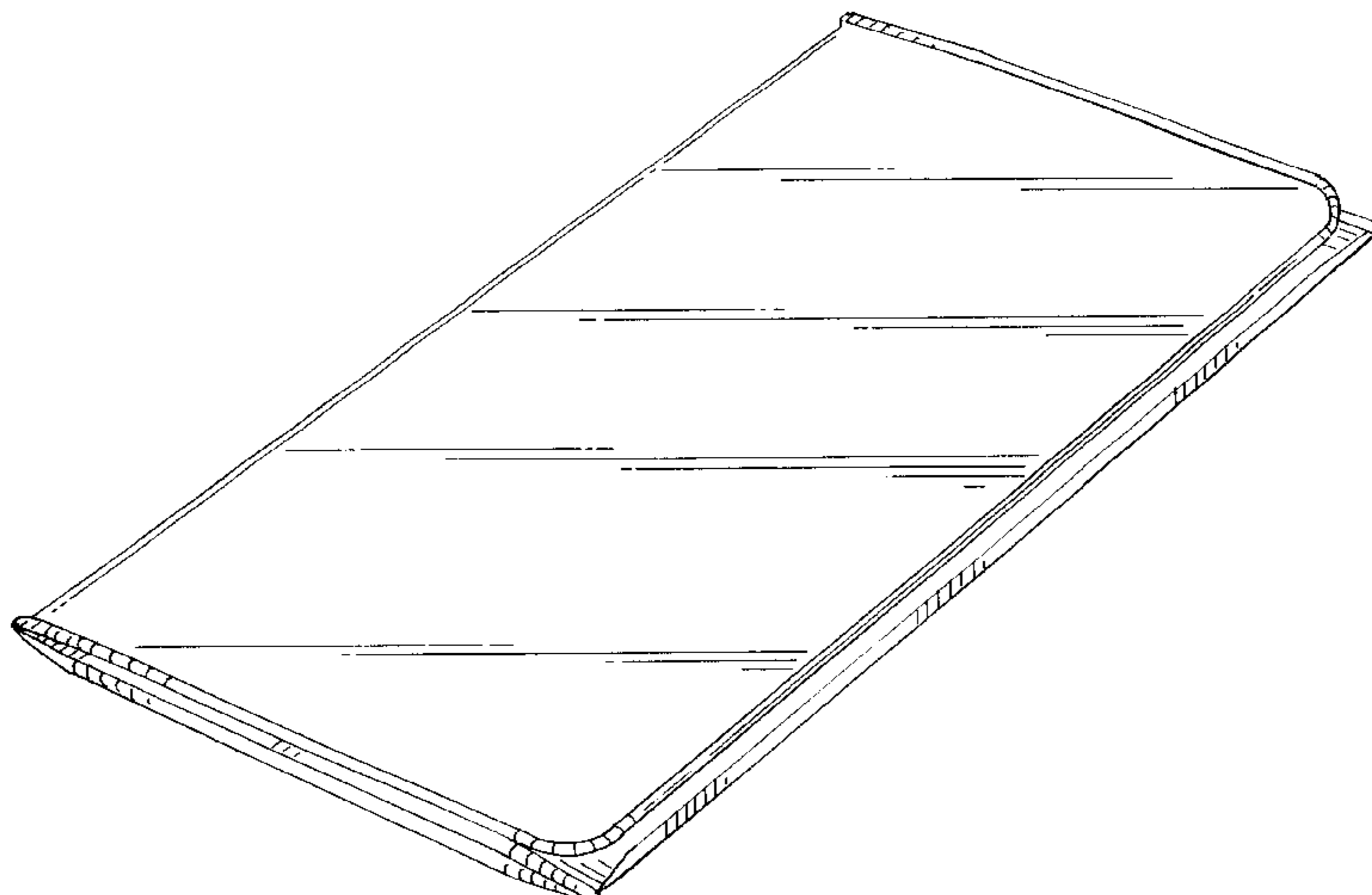

FIG. 1

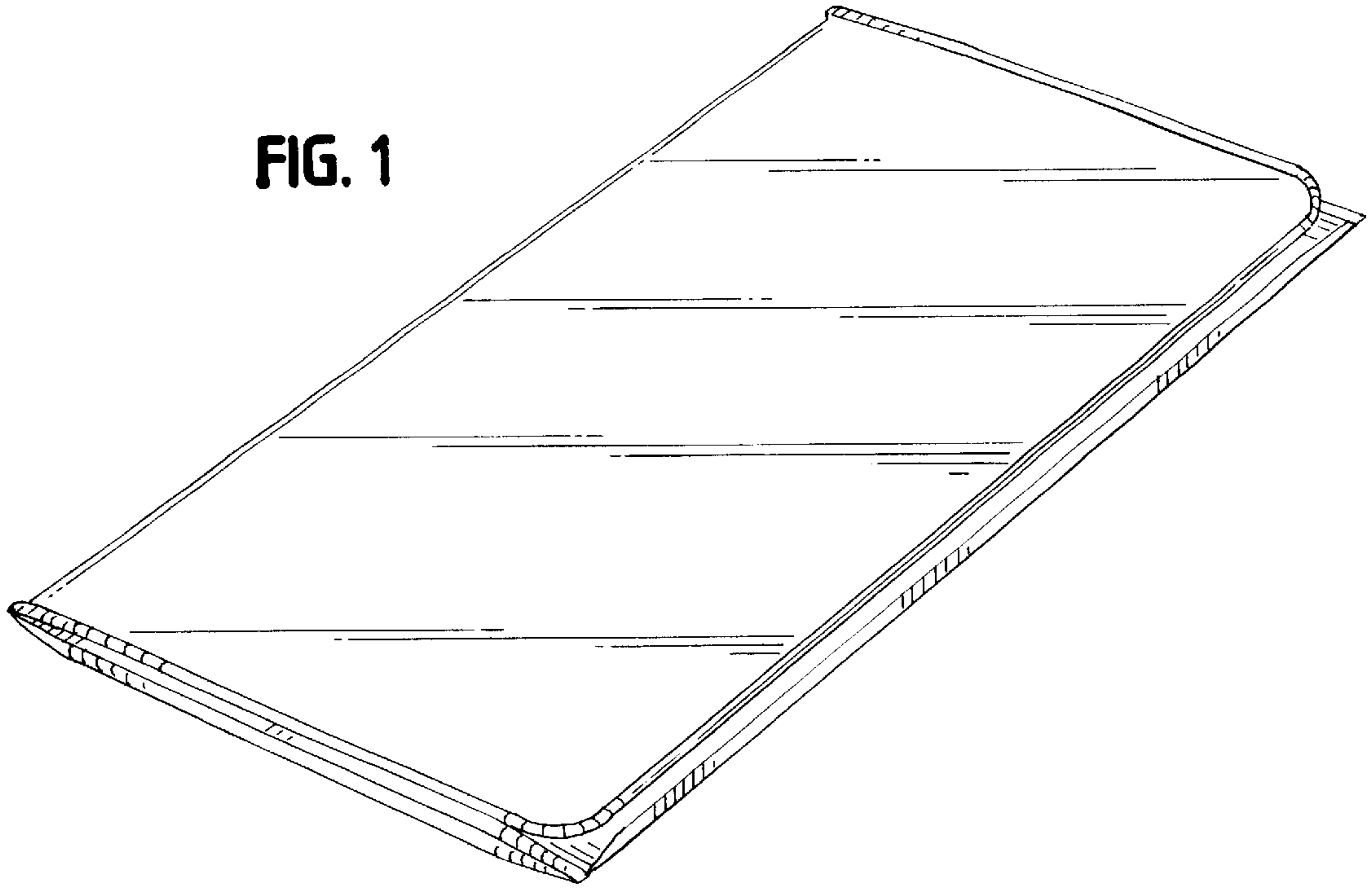

FIG. 2

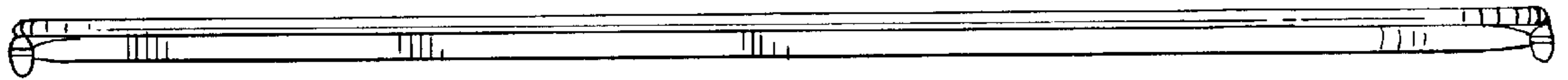

FIG. 3

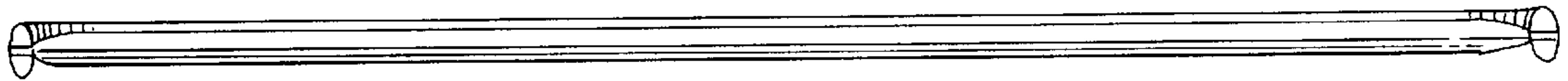

FIG. 4

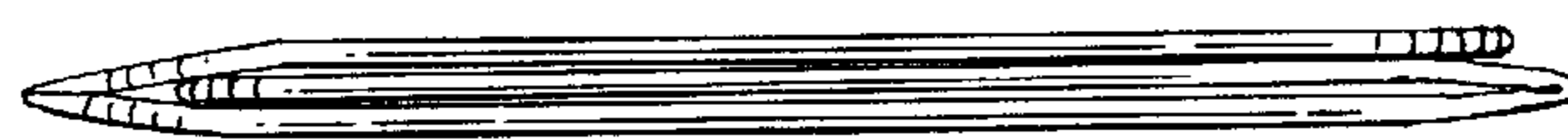

FIG. 5

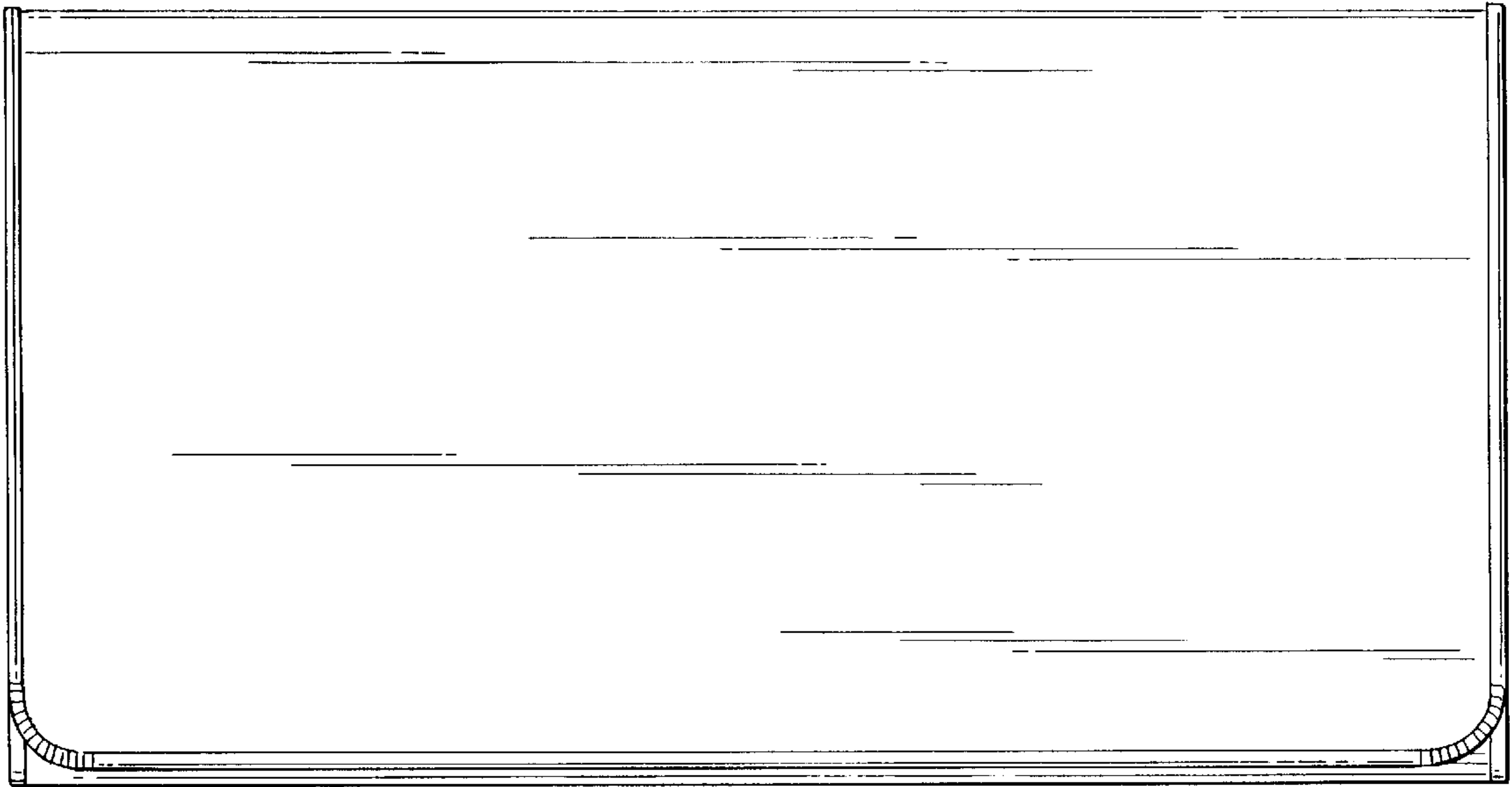

FIG. 6

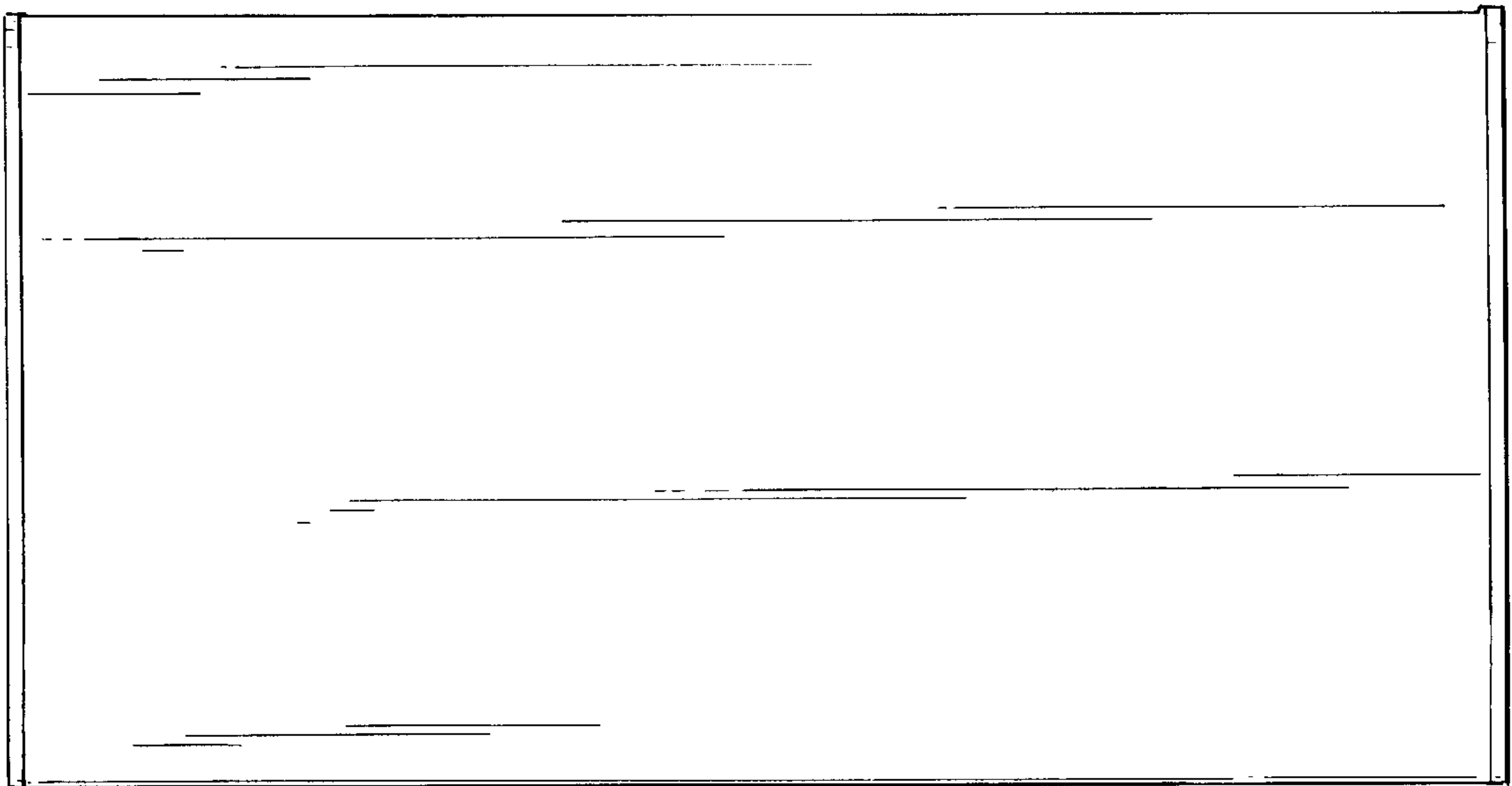

FIG. 7

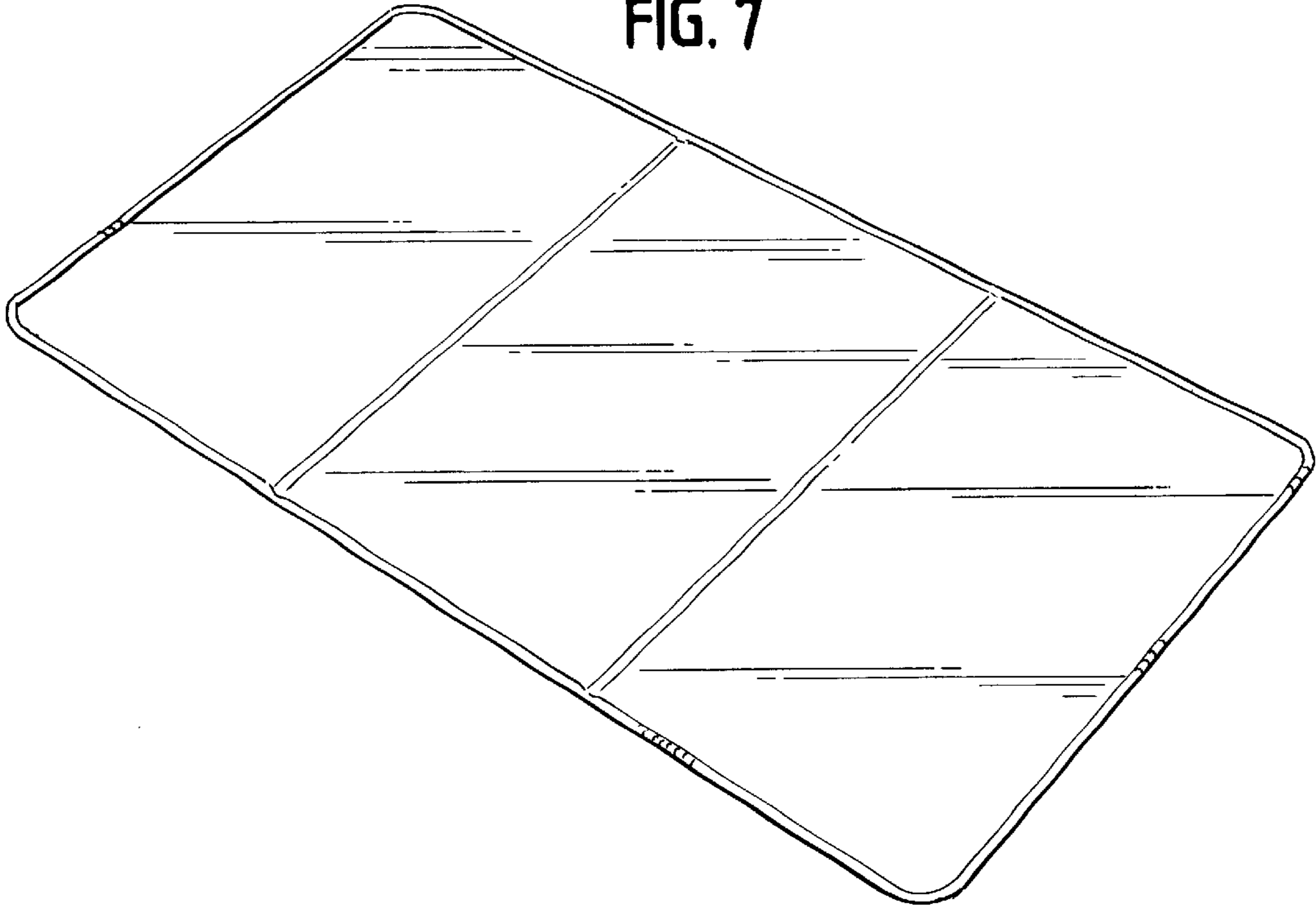

FIG. 8

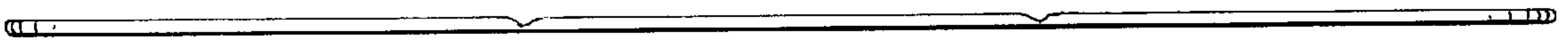

FIG. 9

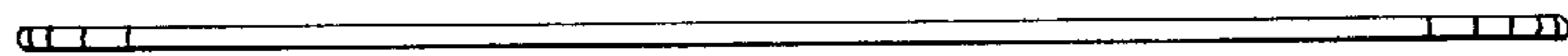

FIG. 10

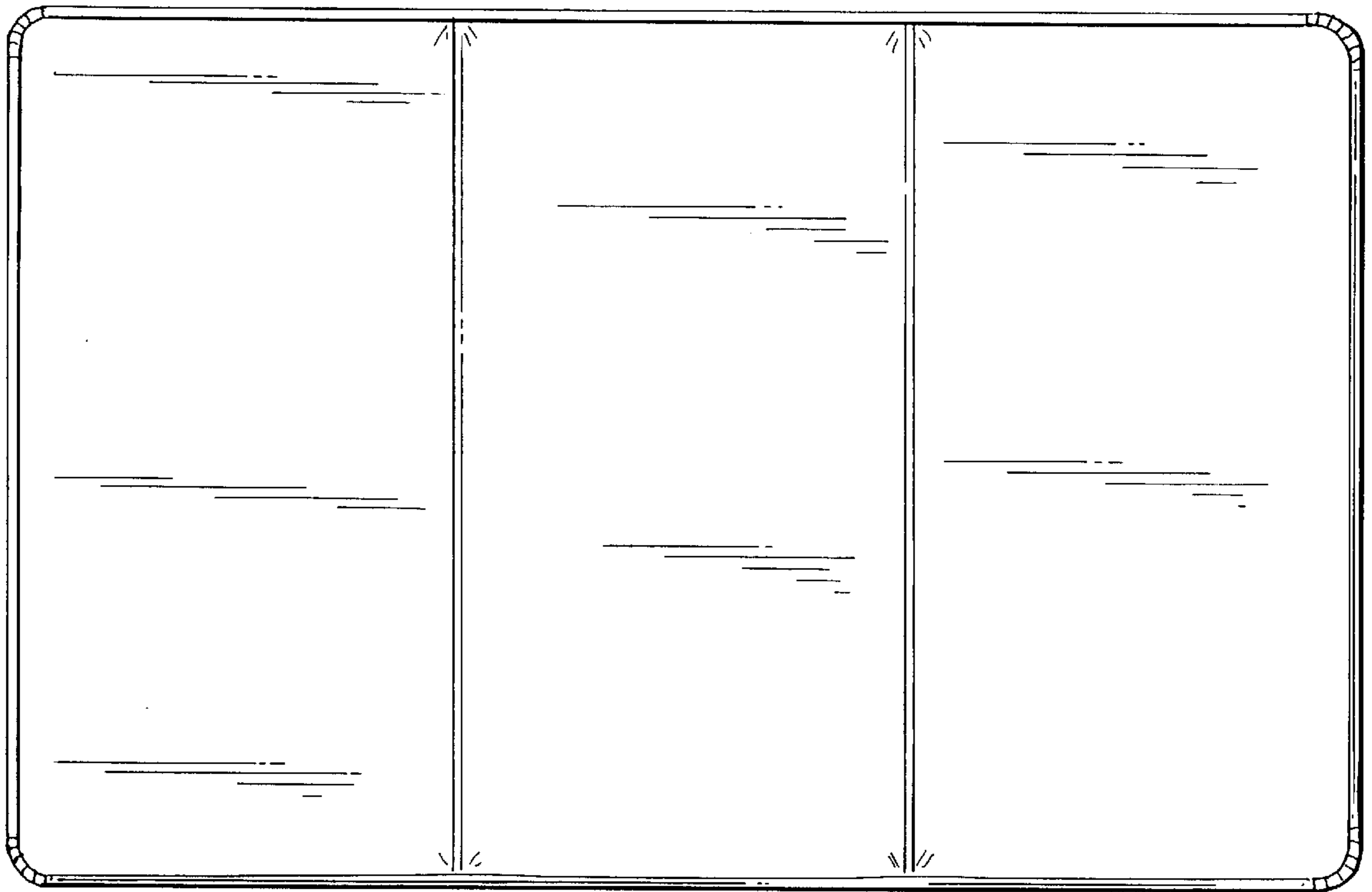

FIG. 11

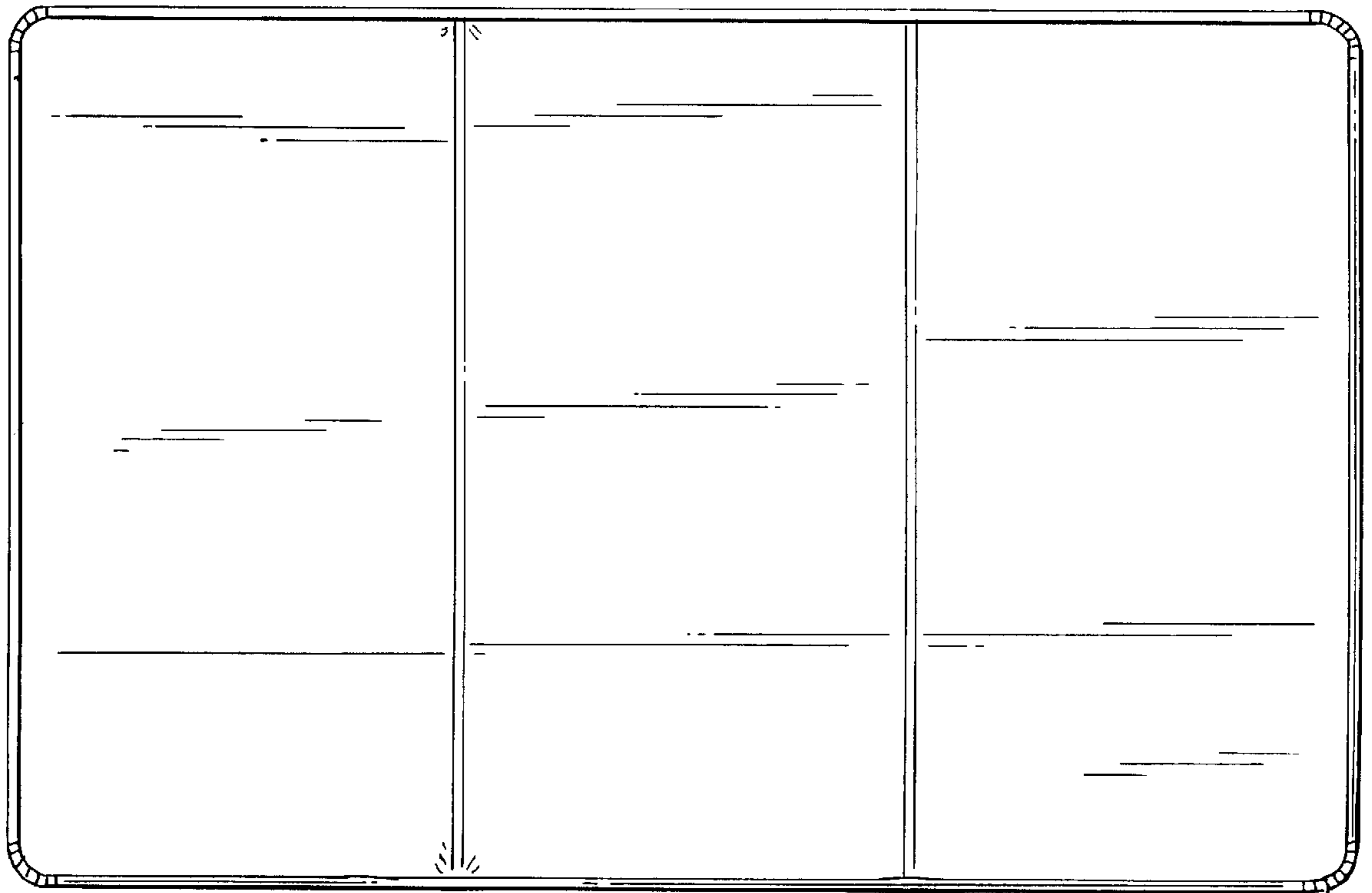

FIG. 12

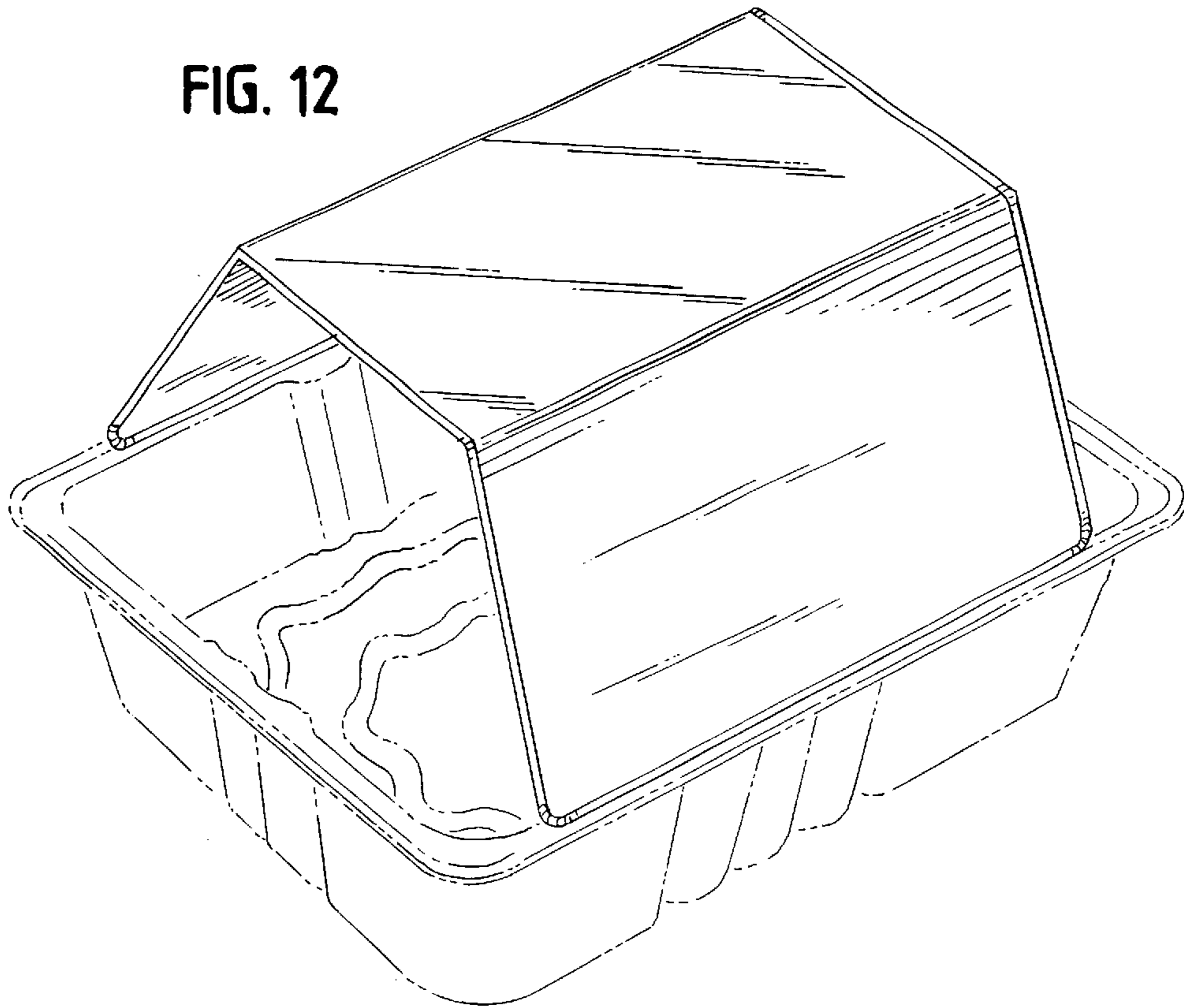

FIG. 13

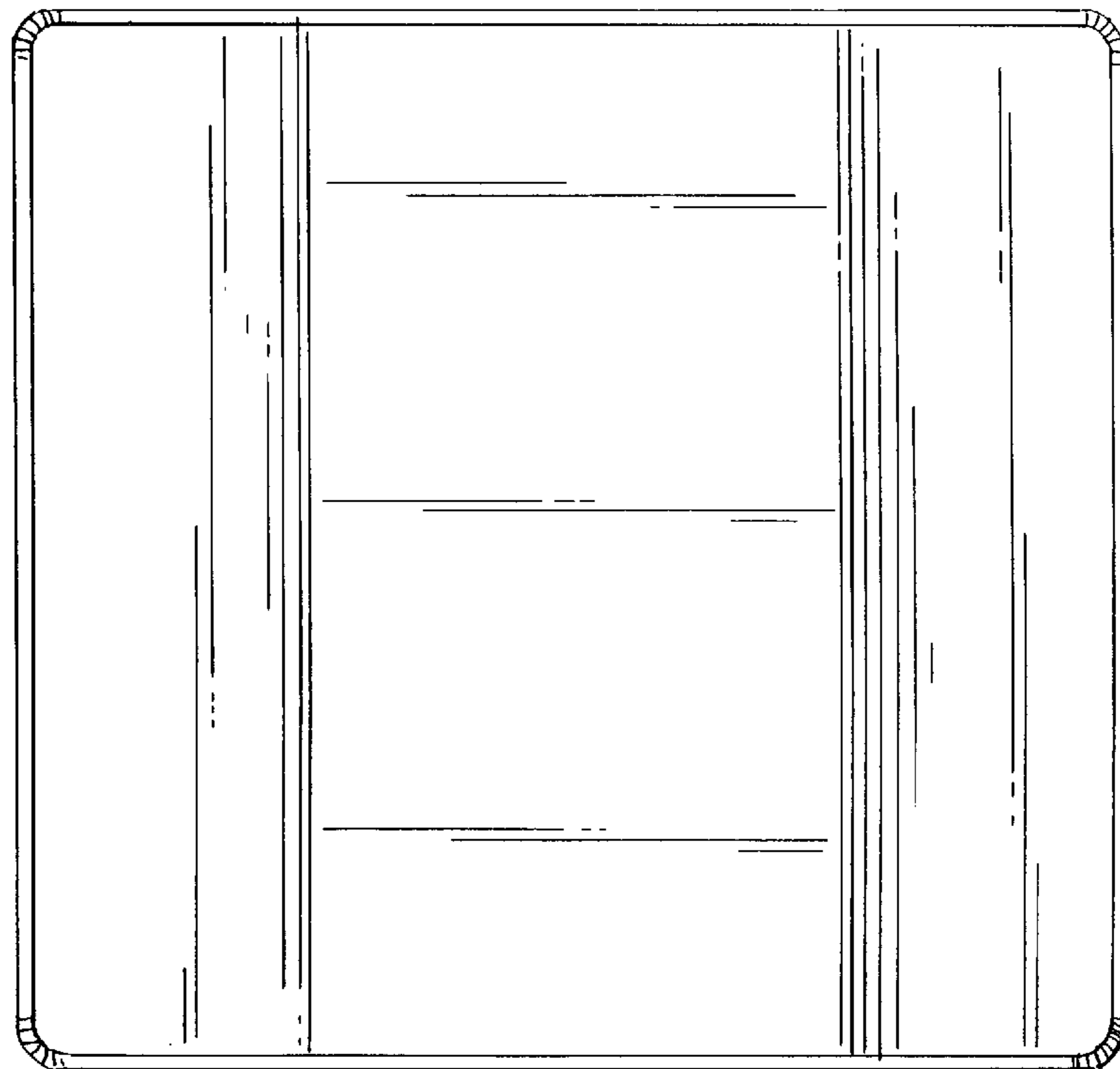

FIG. 14

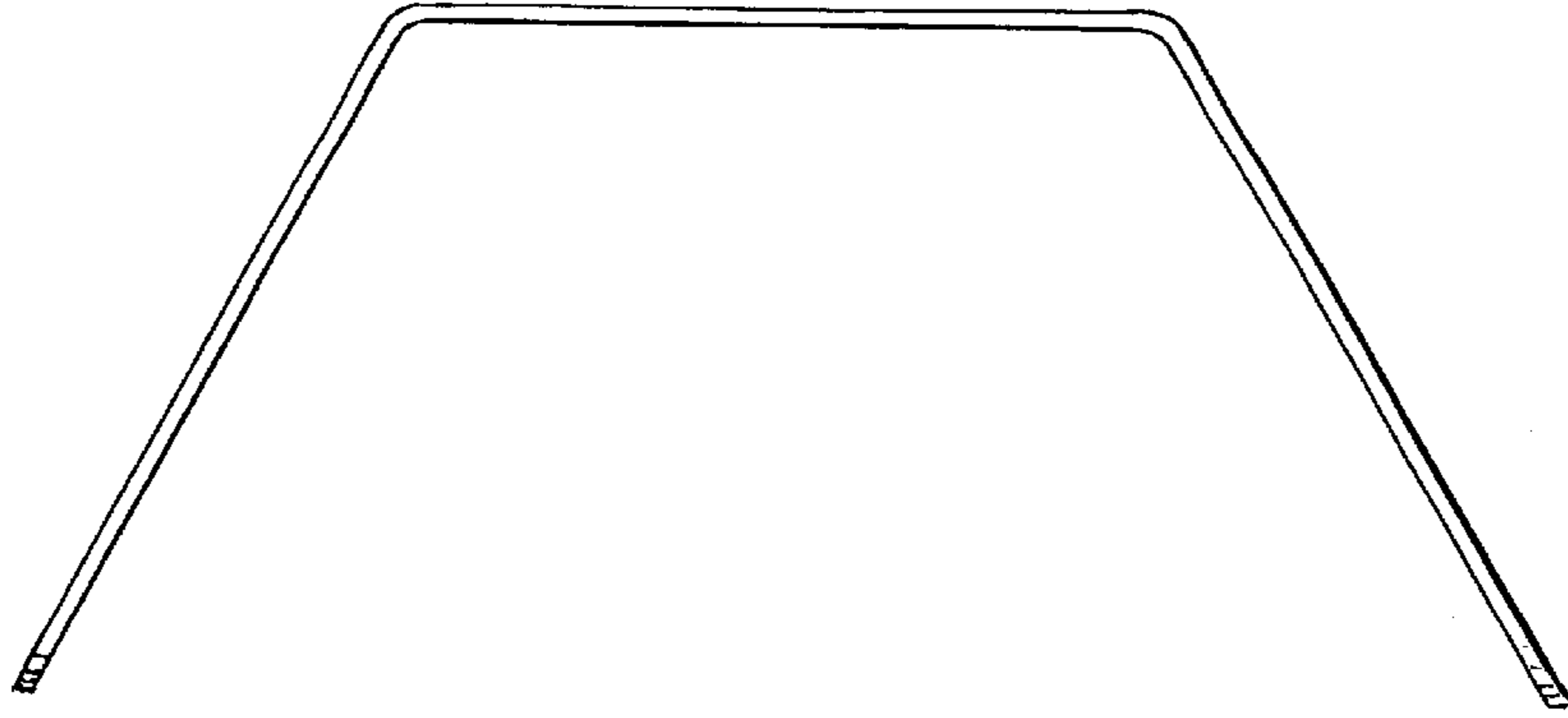

FIG. 15

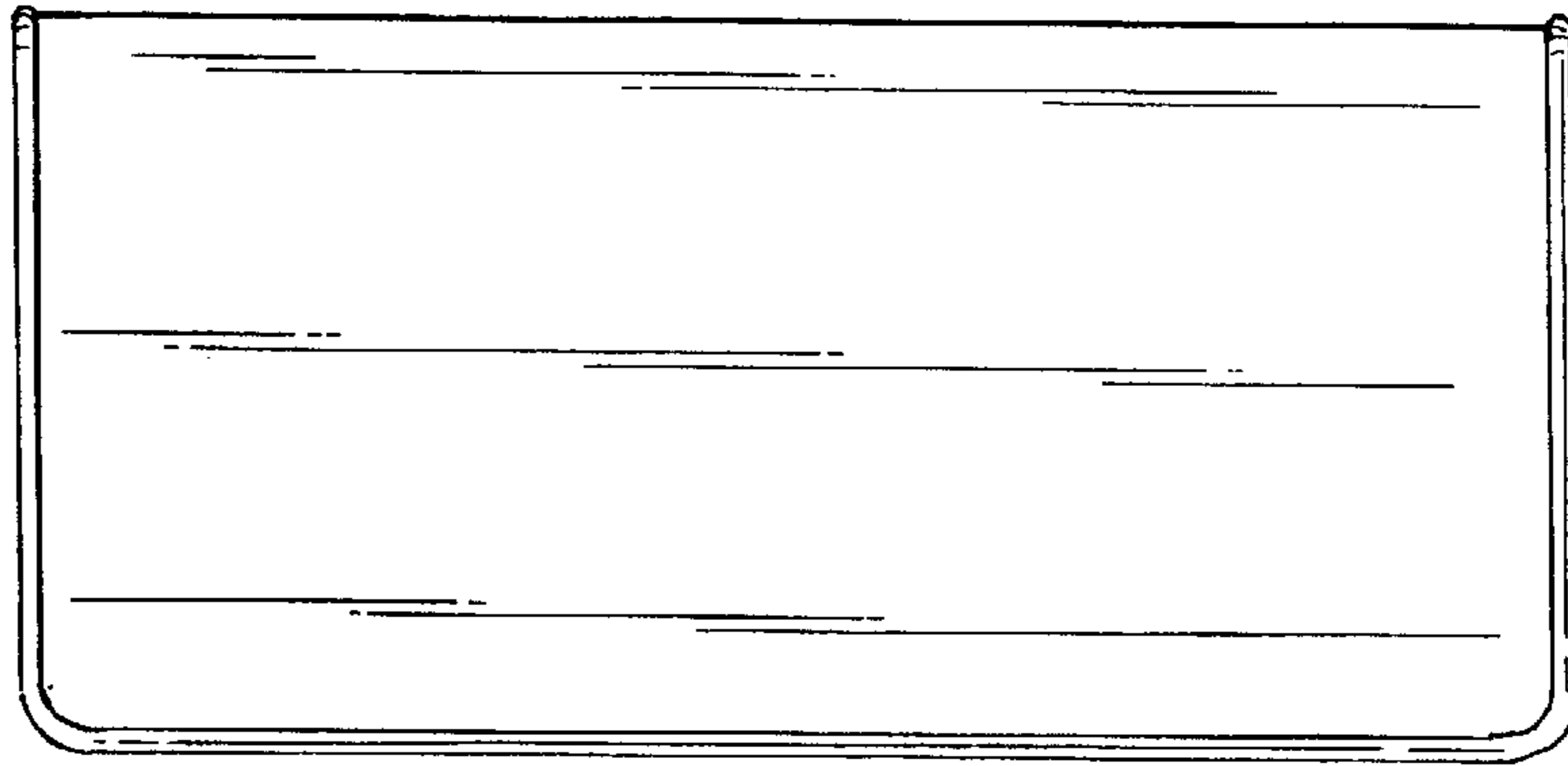

FIG. 16

