



US00D484695S

(12) **United States Design Patent**  
**DePalma**

(10) **Patent No.:** **US D484,695 S**

(45) **Date of Patent:** **\*\* Jan. 6, 2004**

(54) **JEWELRY CONTAINER**

(75) **Inventor:** **Roxanne DePalma**, San Clemente, CA (US)

(73) **Assignee:** **DePalma Enterprises**, San Clemente, CA (US)

(\*\*) **Term:** **14 Years**

(21) **Appl. No.:** **29/174,686**

(22) **Filed:** **Jan. 22, 2003**

(51) **LOC (7) Cl.** ..... **03-01**

(52) **U.S. Cl.** ..... **D3/284; D3/902; D3/290**

(58) **Field of Search** ..... D3/273, 276, 281, D3/283, 284, 285, 294, 295, 296, 903; 206/6.1, 566, 581

(56) **References Cited**

**U.S. PATENT DOCUMENTS**

5,692,605 A	*	12/1997	Lai	.....	206/6.1
D393,542 S	*	4/1998	Thompson	.....	D3/294
D395,755 S	*	7/1998	Hulin	.....	D3/295
D417,783 S	*	12/1999	Wolf	.....	D3/297

D451,671 S	*	12/2001	Wolf	.....	D3/275
D454,687 S	*	3/2002	Wolf	.....	D3/275
D455,550 S	*	4/2002	Wolf	.....	D3/275
D455,902 S	*	4/2002	Wolf	.....	D3/275
D457,315 S	*	5/2002	Wolf	.....	D3/290

\* cited by examiner

*Primary Examiner*—Philip S. Hyder

(74) *Attorney, Agent, or Firm*—Edwards & Angell, LLP

(57) **CLAIM**

The ornamental design for a jewelry container, as shown and described.

**DESCRIPTION**

FIG. 1 is a front elevational view of the jewelry container showing a new design;  
FIG. 2 is a rear elevational view thereof;  
FIG. 3 is a right side elevational view thereof;  
FIG. 4 is a left side elevational view thereof;  
FIG. 5 is a top plan view thereof;  
FIG. 6 is a bottom plan view thereof; and,  
FIG. 7 is a perspective view of the interior thereof in which the jewelry container is open.

**1 Claim, 4 Drawing Sheets**

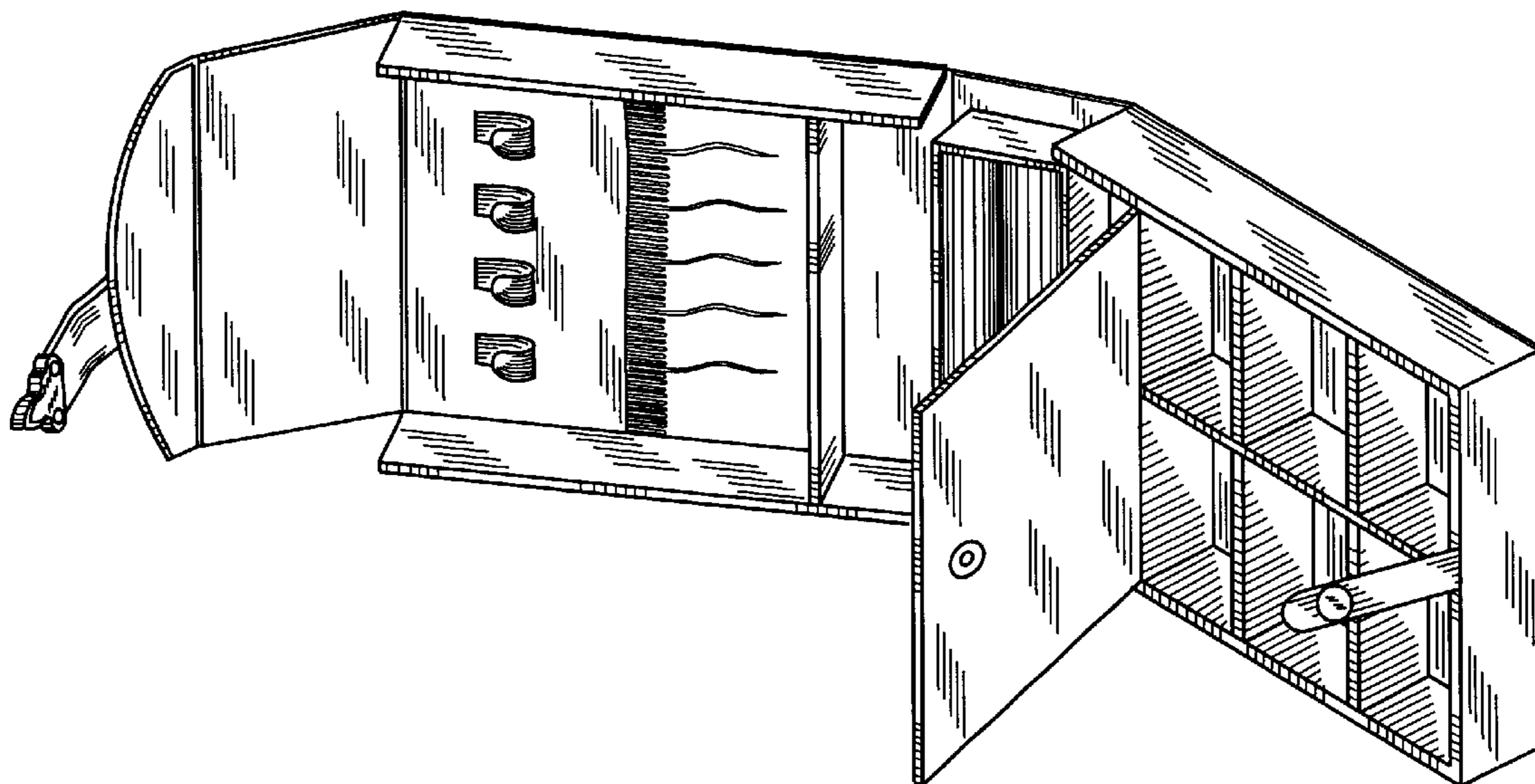

*FIG. 1*

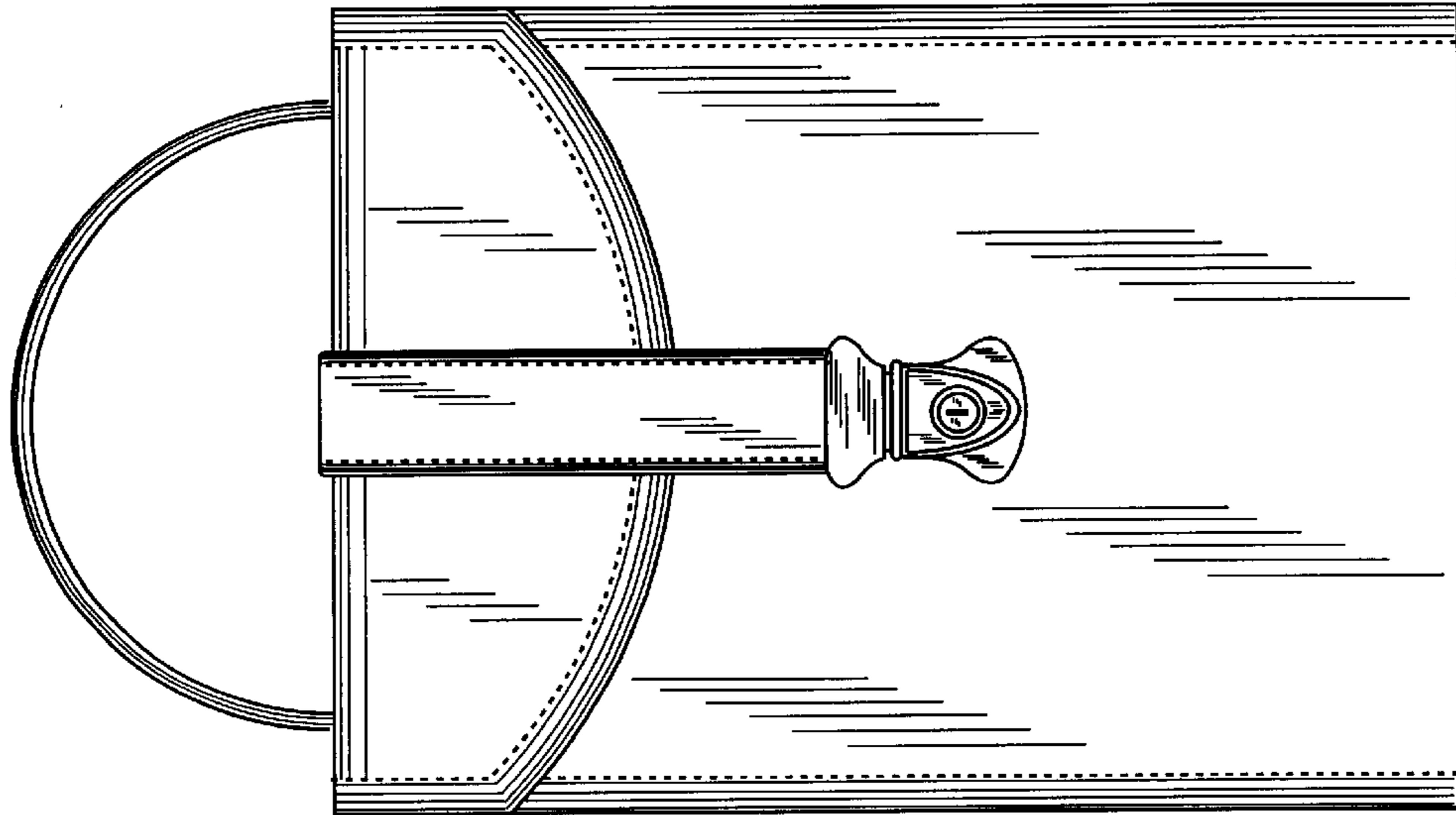

*FIG. 2*

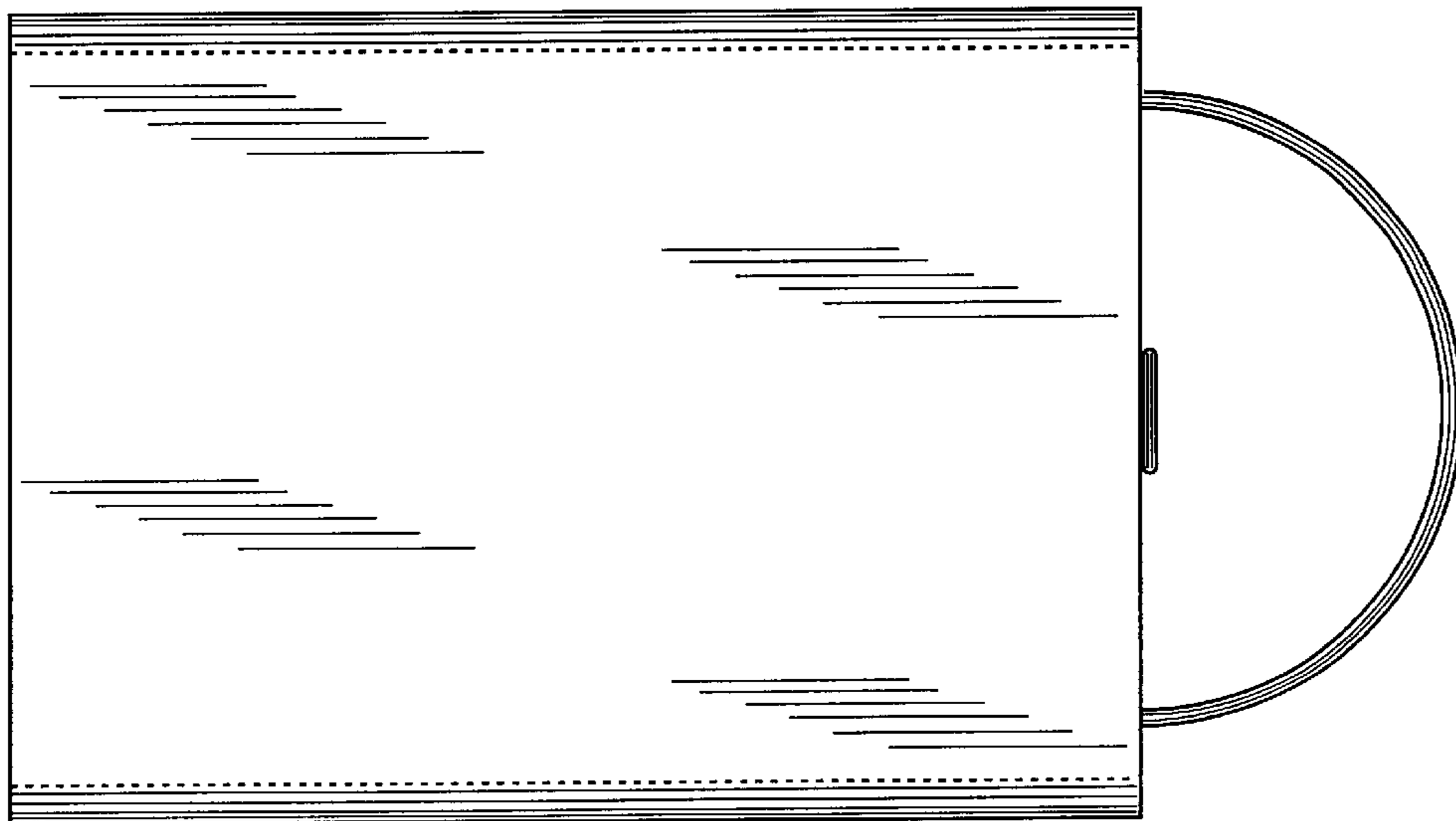

*FIG. 3*

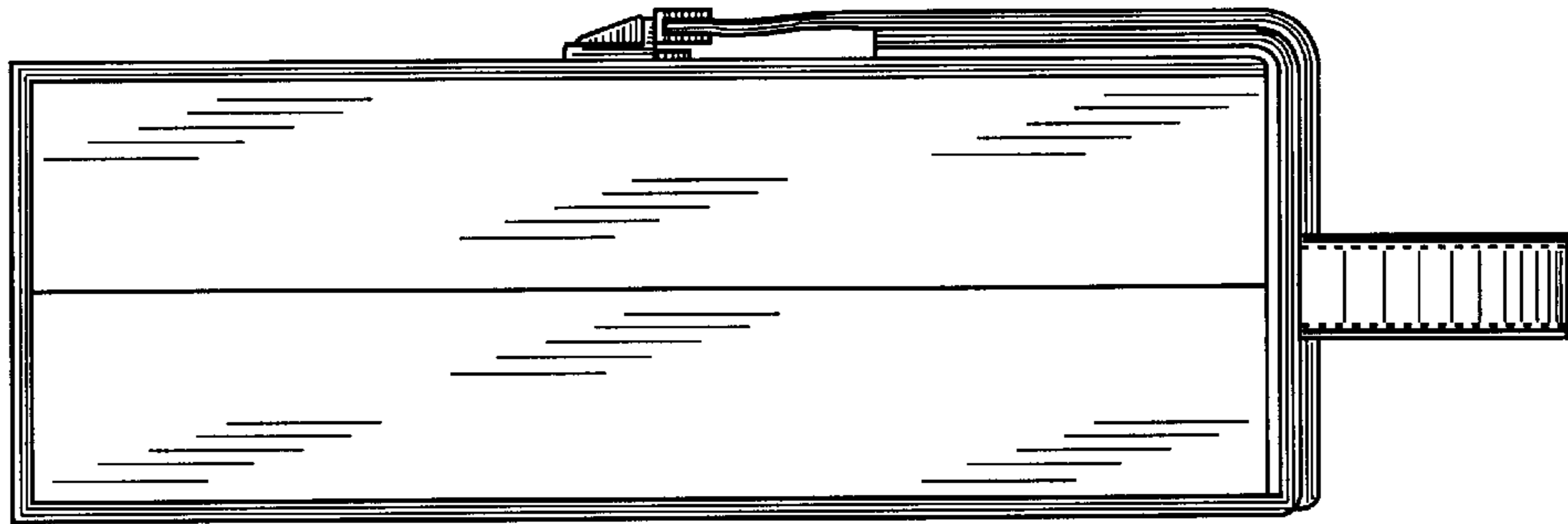

*FIG. 4*

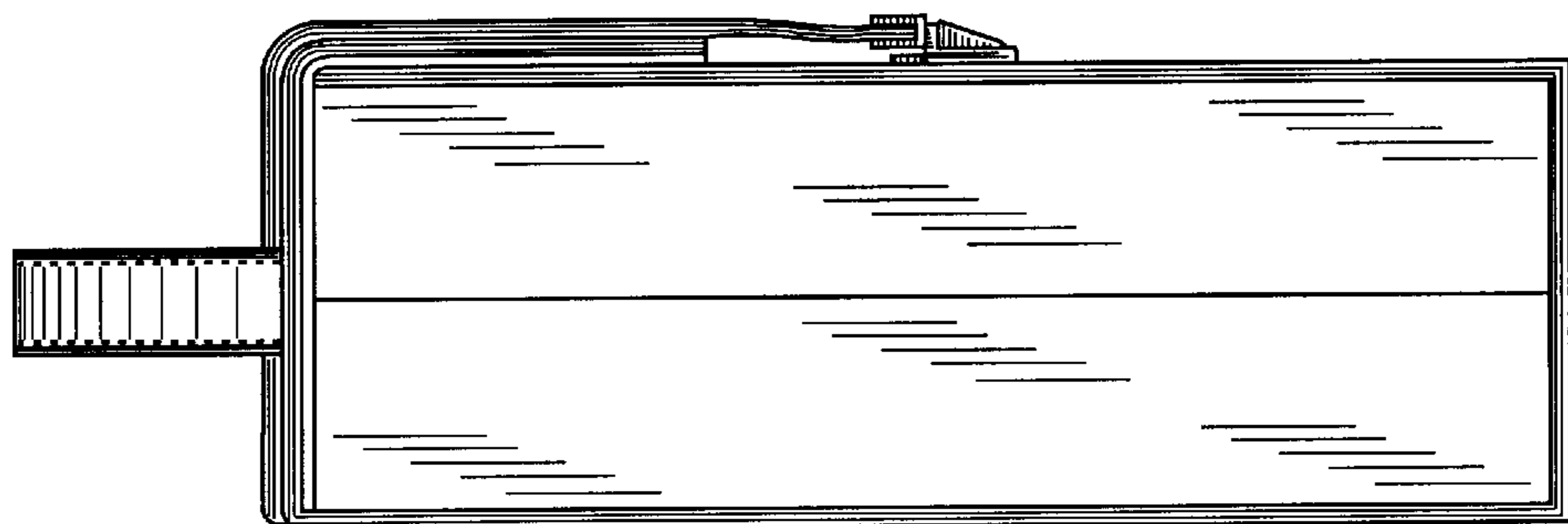

*FIG. 5*

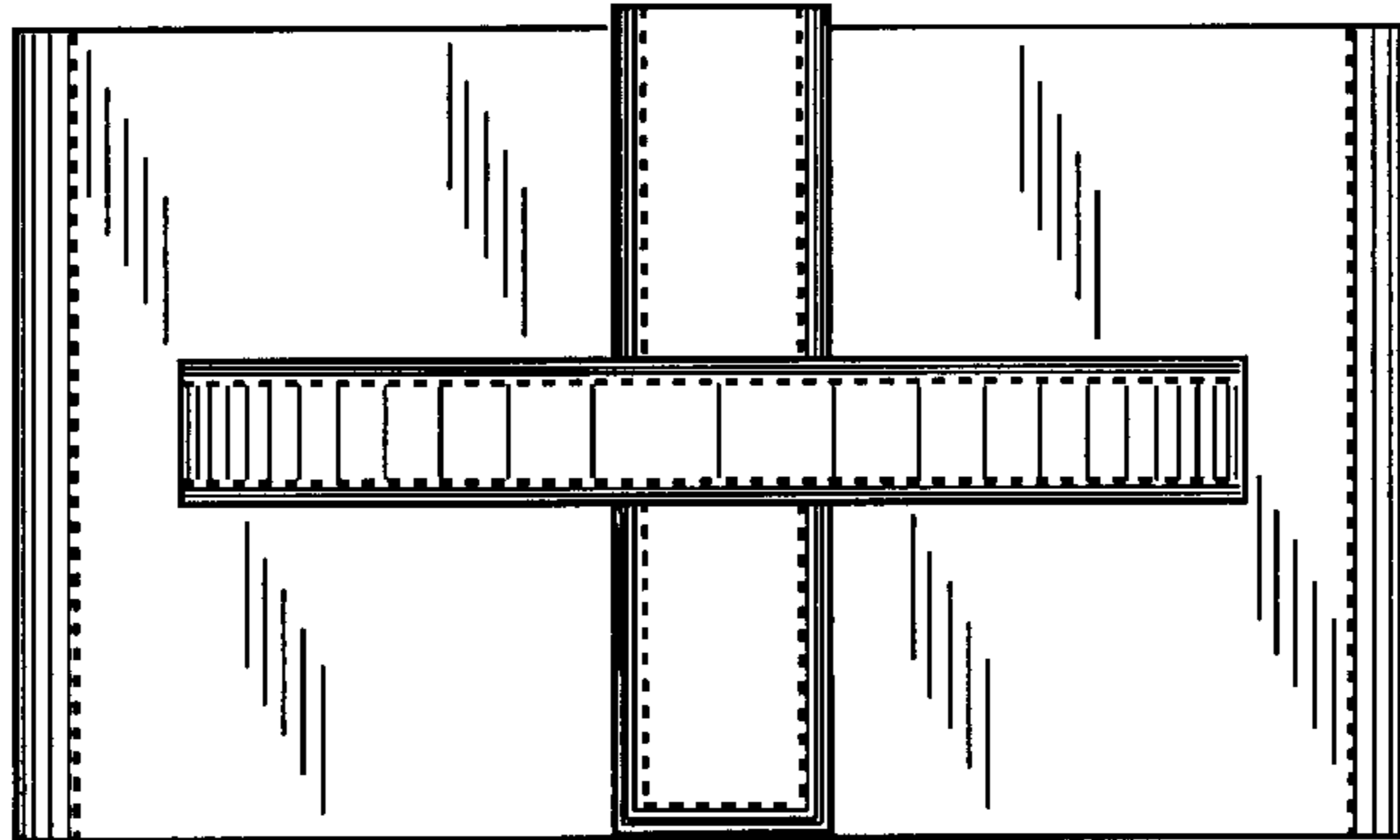

*FIG. 6*

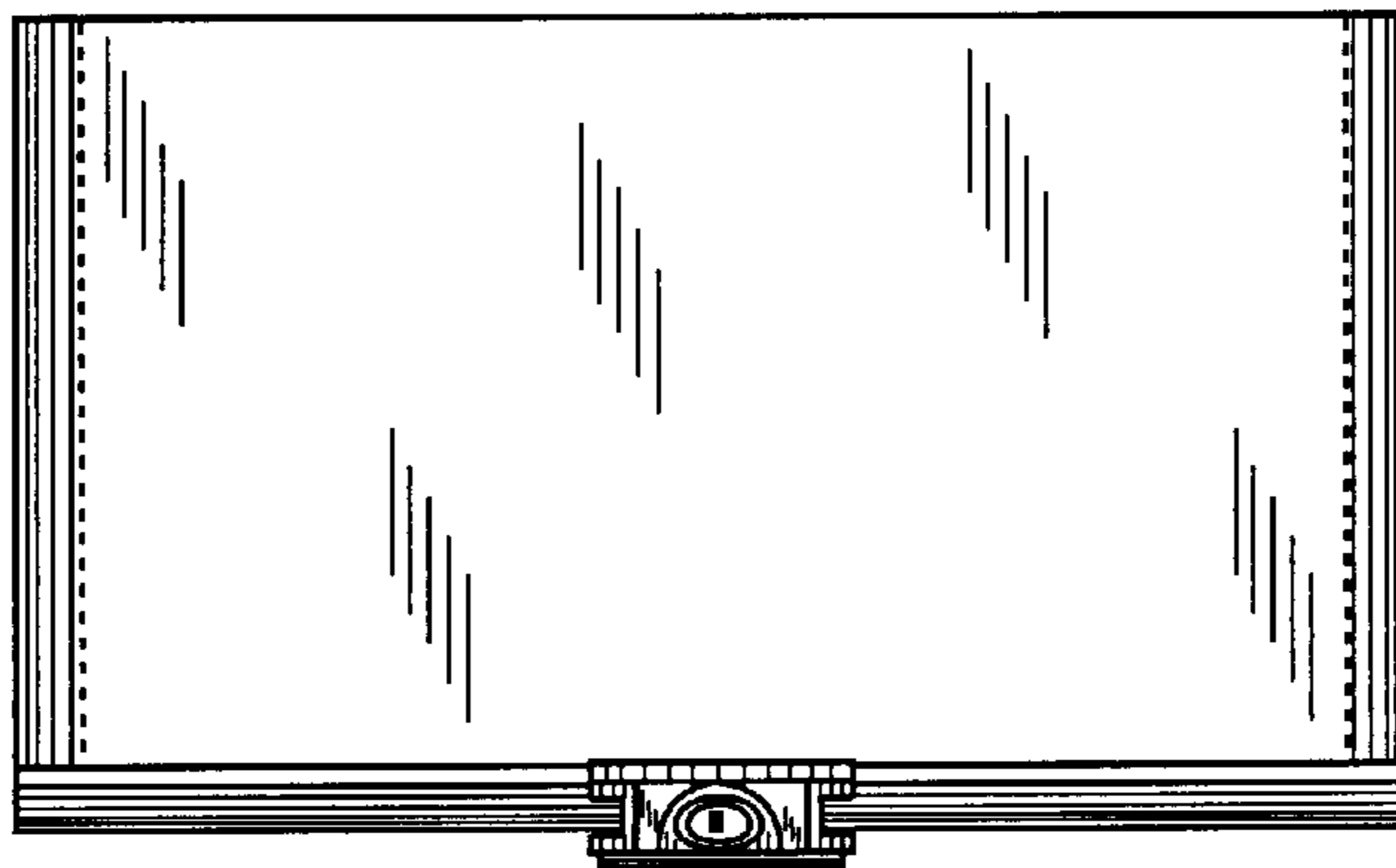

FIG 7

