



US00D484598S

(12) **United States Design Patent**
Ina et al.

(10) **Patent No.:** **US D484,598 S**

(45) **Date of Patent:** **** Dec. 30, 2003**

(54) **SORTER FOR MEDICAL IMAGE PRINTER**

(75) Inventors: **Takao Ina**, Tokyo (JP); **Shozo Kondo**, Tokyo (JP); **Aya Ohkawa**, Tokyo (JP)

(73) Assignee: **Fuji Photo Film Co., Ltd.**, Kanagawa (JP)

(**) Term: **14 Years**

(21) Appl. No.: **29/177,383**

(22) Filed: **Mar. 11, 2003**

(30) **Foreign Application Priority Data**

Oct. 15, 2002 (JP) 2002-028095

(51) **LOC (7) Cl.** **24-01**

(52) **U.S. Cl.** **D24/158**

(58) **Field of Search** D24/158; 378/182, 378/183, 185; 396/589, 594; 271/292, 297, 299, 300, 303, 305; D16/247

(56) **References Cited**

U.S. PATENT DOCUMENTS

- D236,158 S * 7/1975 Hope et al. D16/247
- 4,819,931 A * 4/1989 Goto et al. 271/287
- D340,520 S * 10/1993 Reibl D24/158
- 5,424,795 A * 6/1995 Endo 396/590

- 5,449,168 A * 9/1995 Olexy et al. 271/297
- D367,872 S * 3/1996 Whitby et al. D16/247
- 5,501,449 A * 3/1996 Olexy et al. 271/292
- D371,843 S * 7/1996 Whitby et al. D24/158
- D372,095 S * 7/1996 Whitby et al. D24/158

* cited by examiner

Primary Examiner—Stella Reid

(74) *Attorney, Agent, or Firm*—Young & Thompson

(57) **CLAIM**

The ornamental design for a sorter for medical image printer, as shown and described.

DESCRIPTION

FIG. 1 is a top, front and side perspective view of a sorter for medical image printer, showing our new design;
 FIG. 2 is a side elevational view thereof;
 FIG. 3 is a side elevational view thereof from the side opposite that shown in FIG. 2;
 FIG. 4 is a top plan view thereof;
 FIG. 5 is a bottom plan view thereof;
 FIG. 6 is a front elevational view thereof;
 FIG. 7 is a rear elevational view thereof; and,
 FIG. 8 is a perspective view thereof, with the broken line showing of the medical image printer being for illustrative purposes only and forming no part of the claimed design.

1 Claim, 4 Drawing Sheets

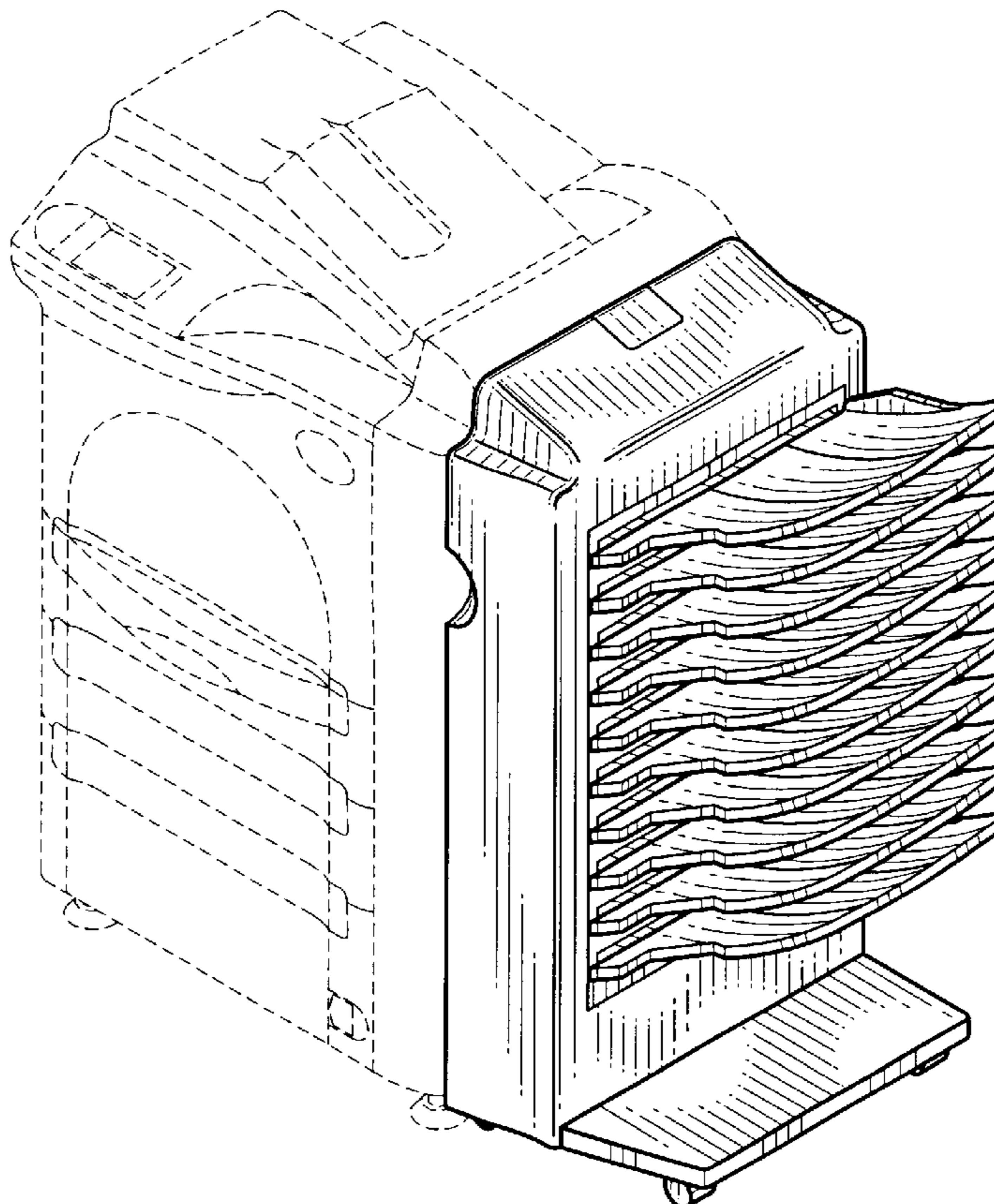

FIG. 1

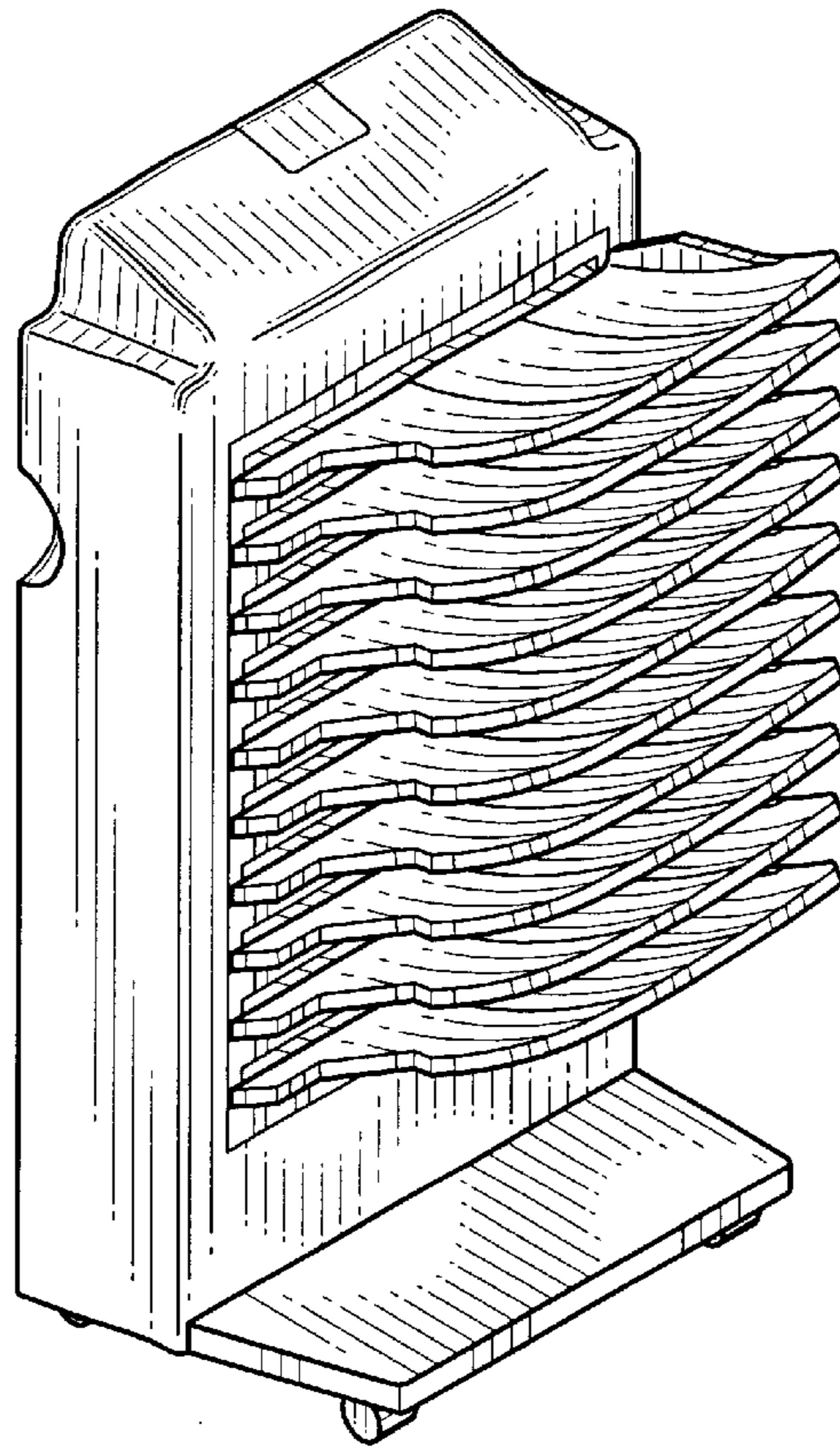

FIG. 2

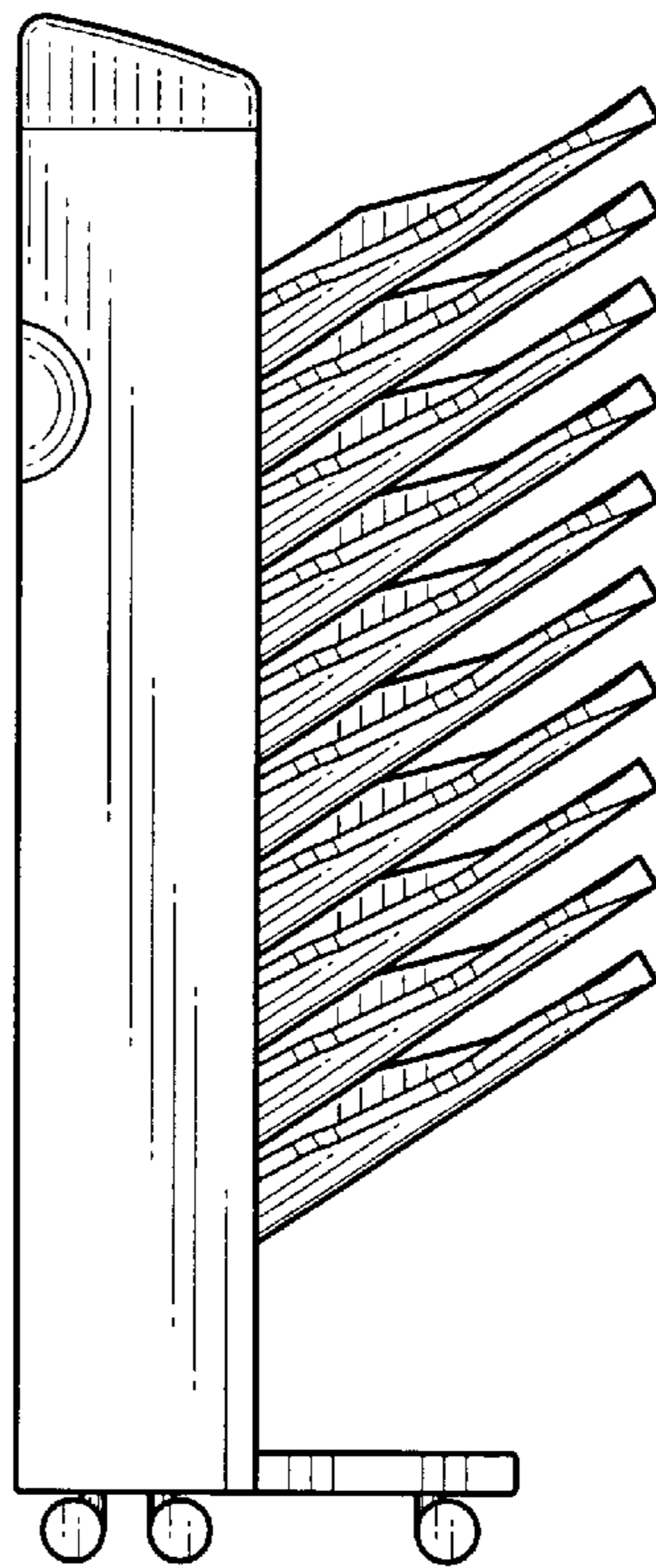

FIG. 3

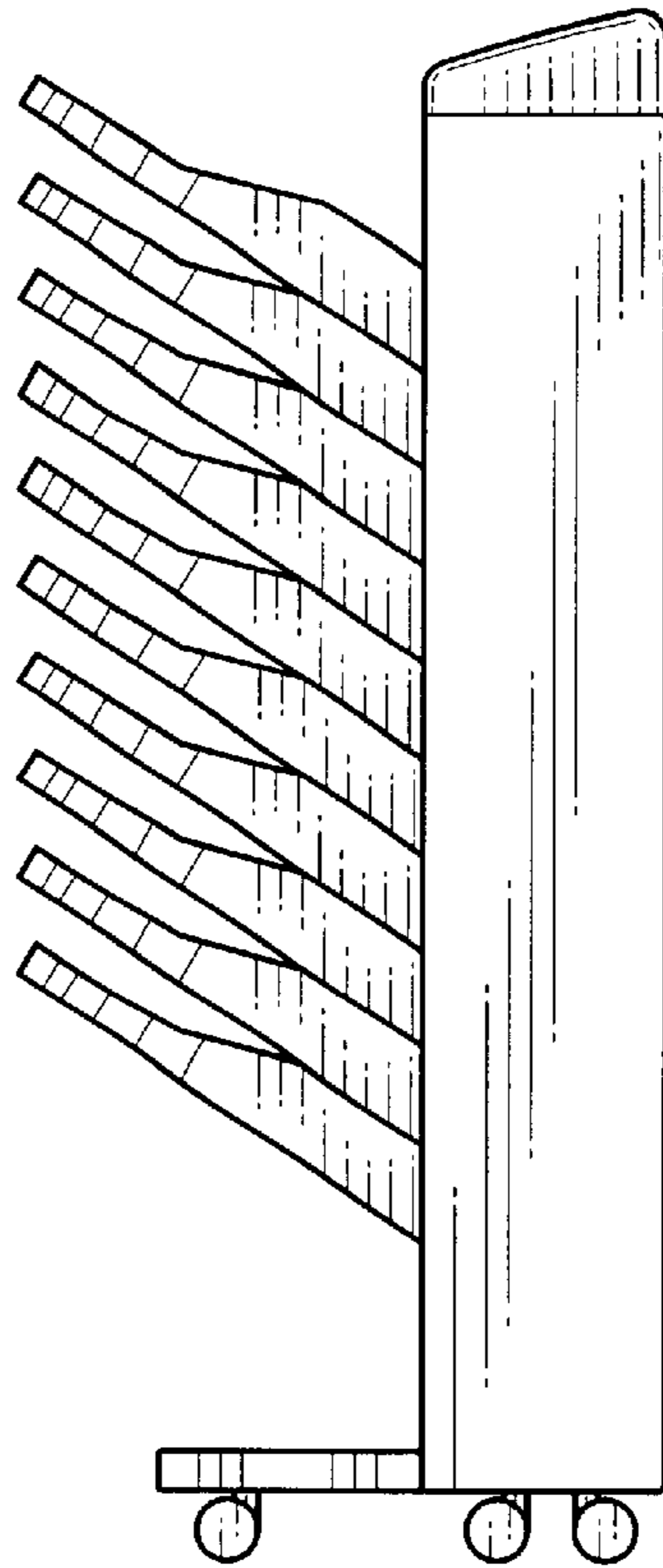

FIG. 4

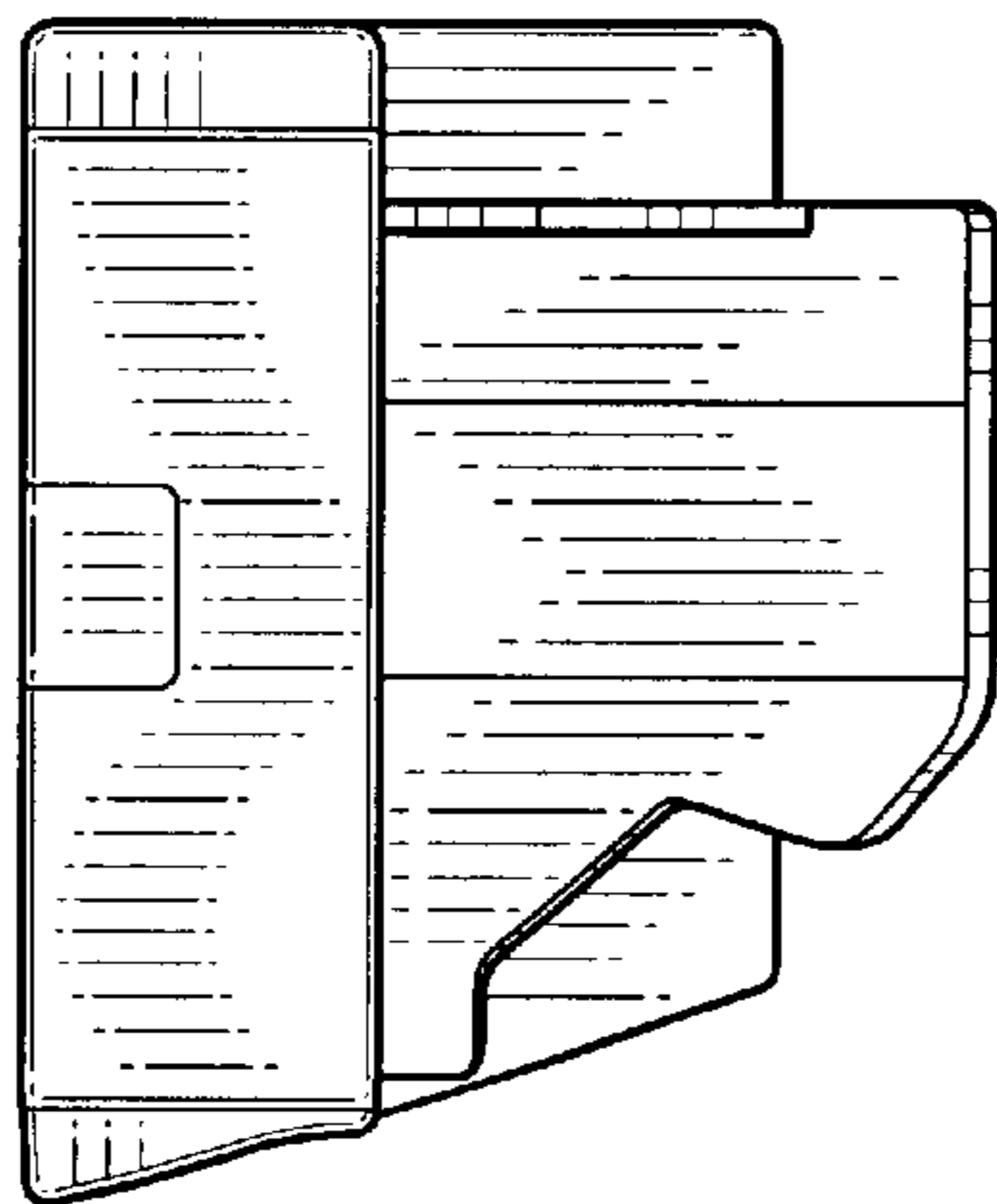

FIG. 5

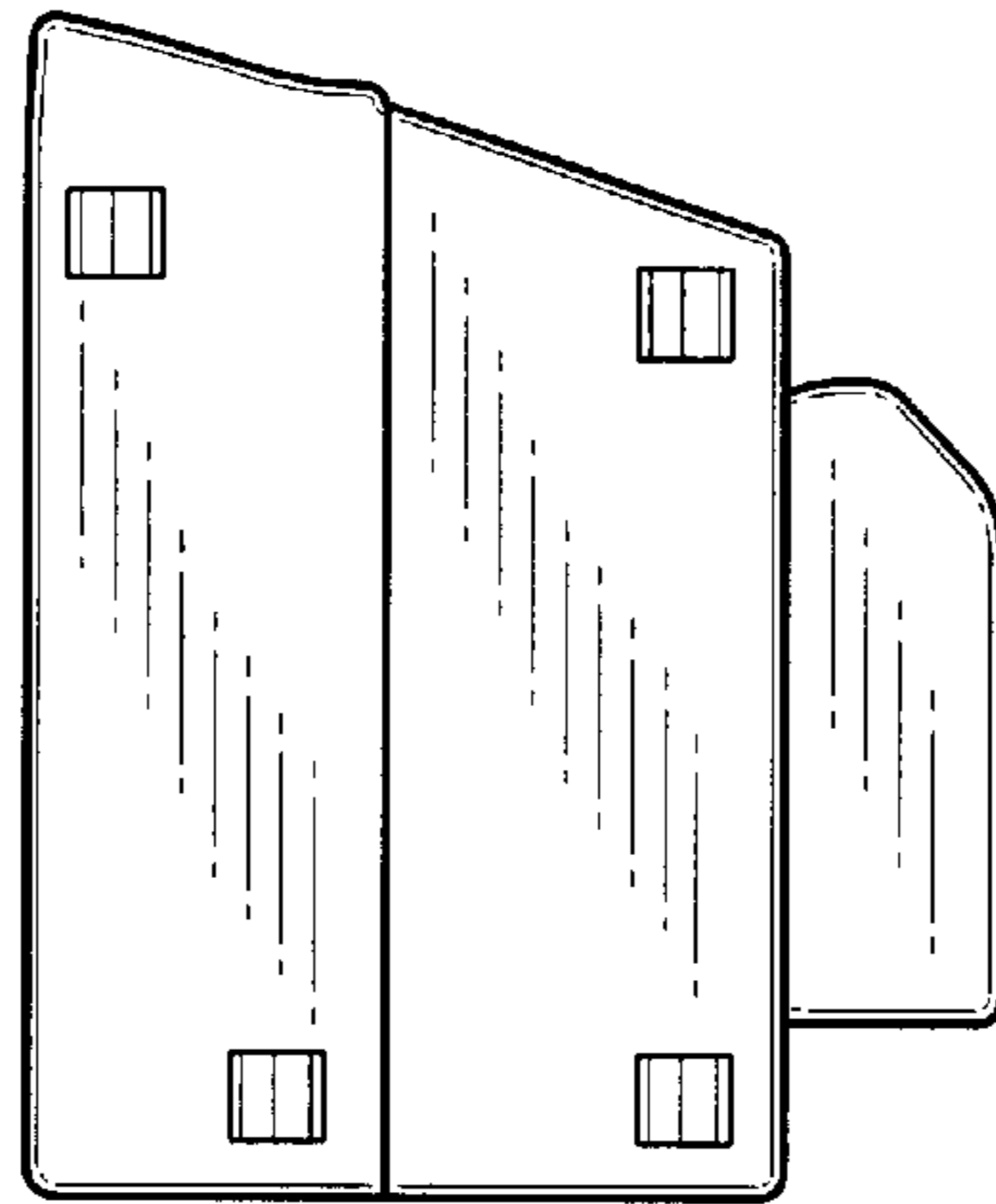

FIG. 6

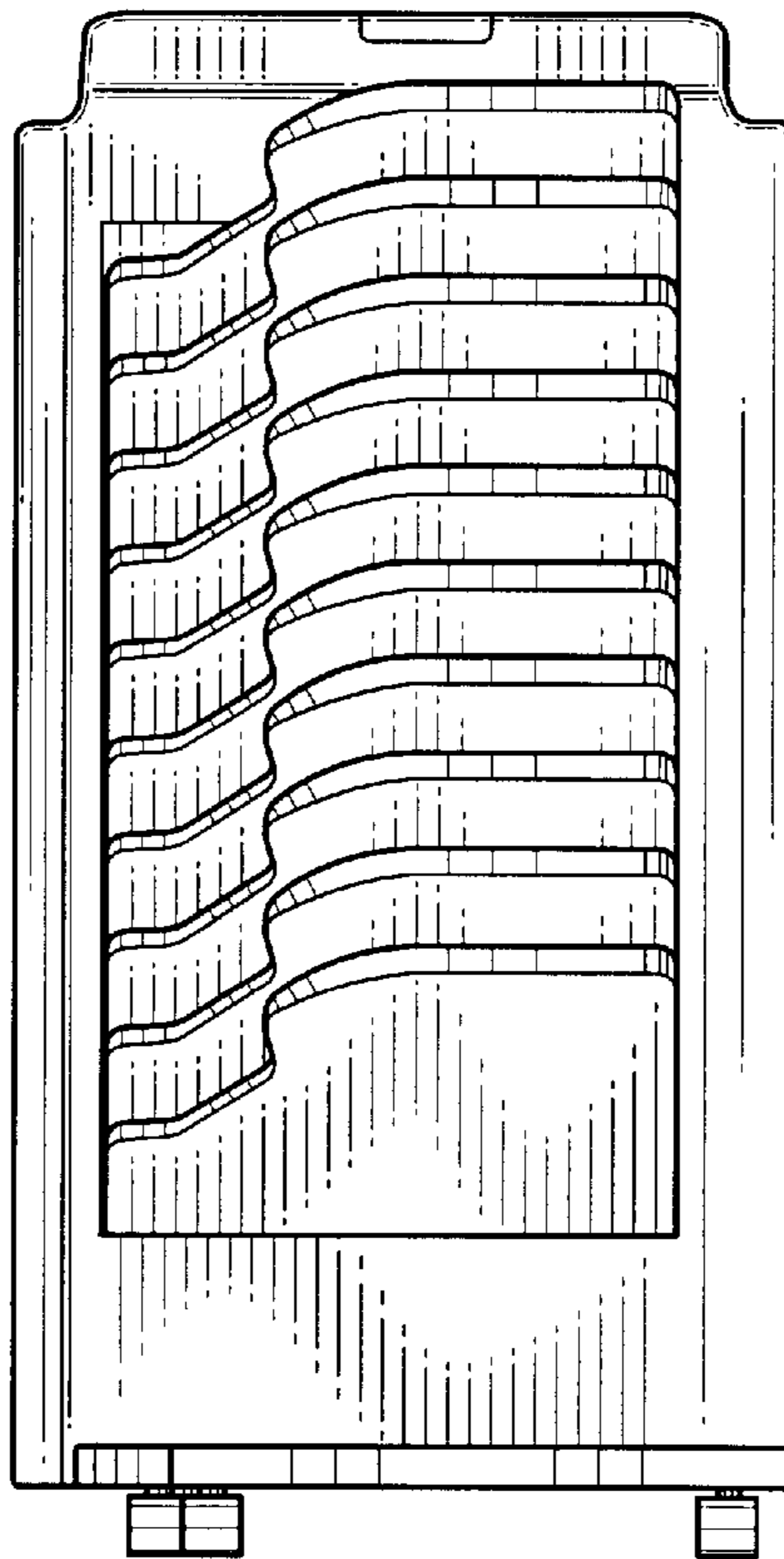

FIG. 7

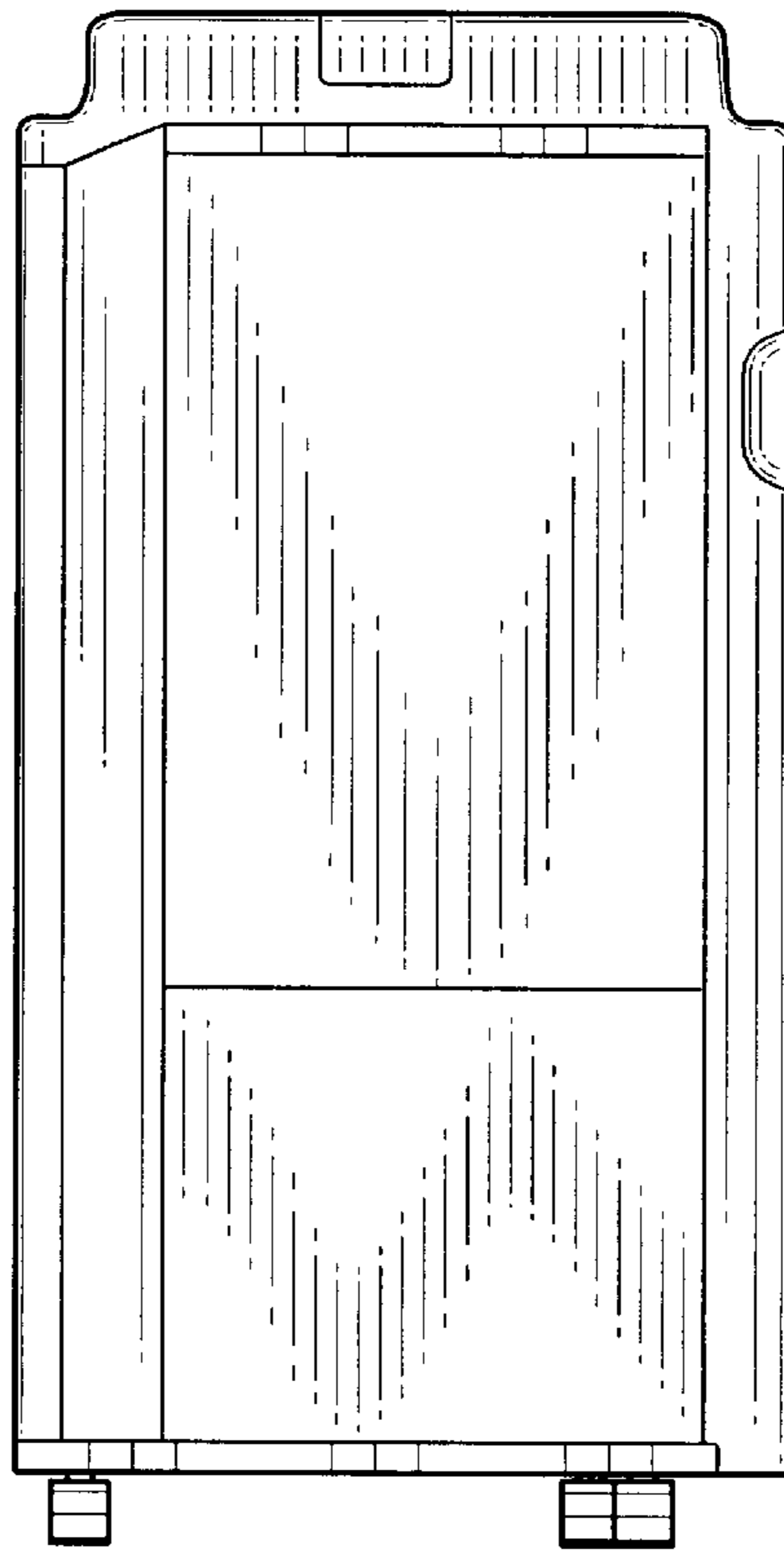

FIG. 8

