



US00D48441S

(12) **United States Design Patent**
Hsia

(10) **Patent No.:** **US D484,441 S**

(45) **Date of Patent:** **** Dec. 30, 2003**

(54) **BABY CART**

D476,926 S * 7/2003 Chen D12/129

(76) Inventor: **Ben M. Hsia**, 19401 Business Center
Dr., Northridge, CA (US) 91324

* cited by examiner

(**) Term: **14 Years**

Primary Examiner—Marcus A. Jackson
(74) *Attorney, Agent, or Firm*—Sheridan Ross PC

(21) Appl. No.: **29/180,617**

(57) **CLAIM**

(22) Filed: **Apr. 24, 2003**

The ornamental design for baby cart, as shown and described.

(51) **LOC (7) Cl.** **12-12**

DESCRIPTION

(52) **U.S. Cl.** **D12/129**

(58) **Field of Search** D12/128-133;
280/30, 42, 642, 644, 647, 648, 649, 650,
47.36, 47.371

FIG. 1 is a perspective view of baby cart showing my new design;
FIG. 2 is a front elevational view thereof;
FIG. 3 is a rear elevational view thereof;
FIG. 4 is a left side elevational view thereof;
FIG. 5 is a right side elevational view thereof;
FIG. 6 is a top plan view thereof; and,
FIG. 7 is a bottom plan view thereof.

(56) **References Cited**

U.S. PATENT DOCUMENTS

- D452,192 S * 12/2001 Hartenstine et al. D12/129
- D455,103 S * 4/2002 Tsai D12/129
- D463,332 S * 9/2002 Wu D12/129

1 Claim, 7 Drawing Sheets

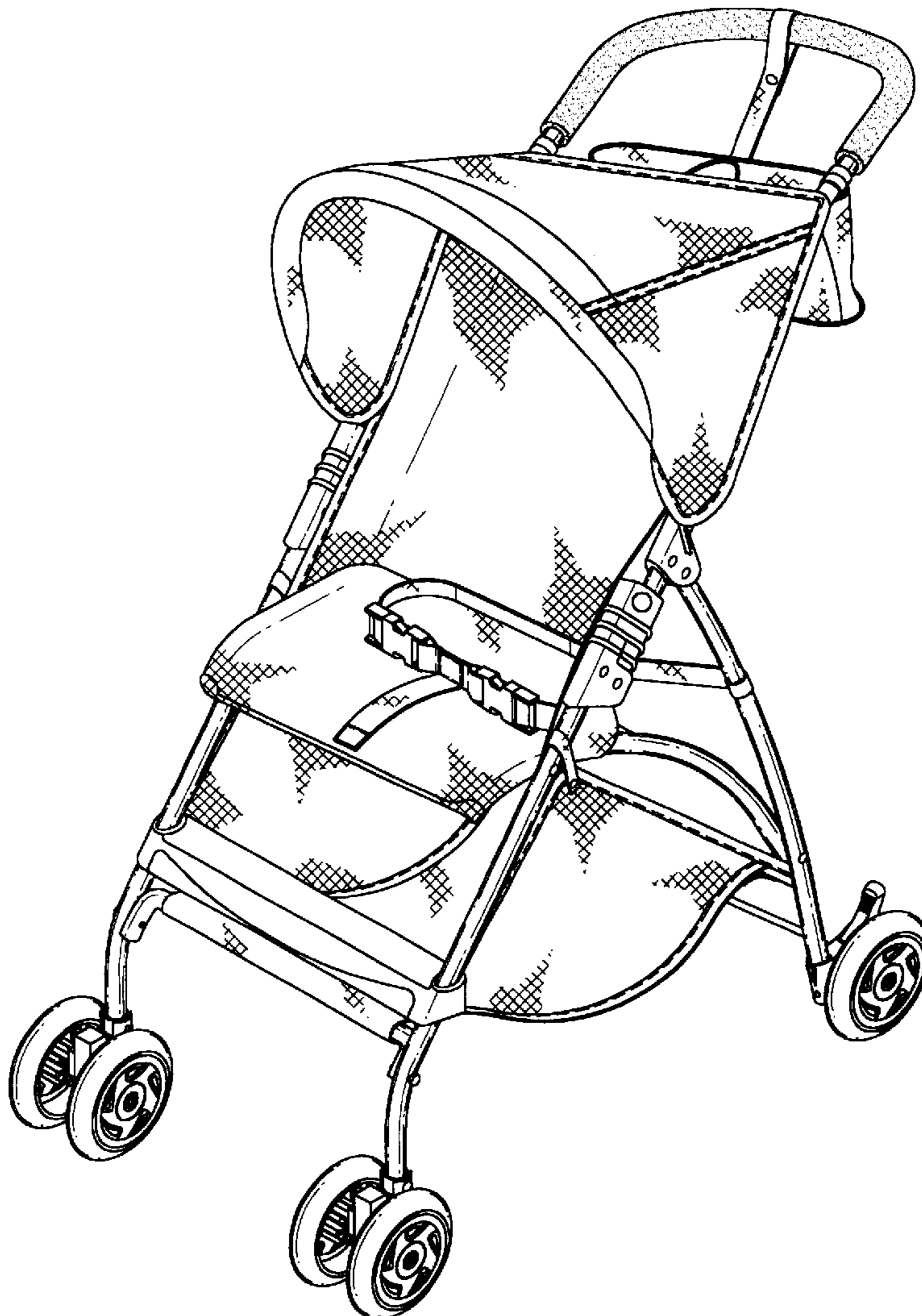

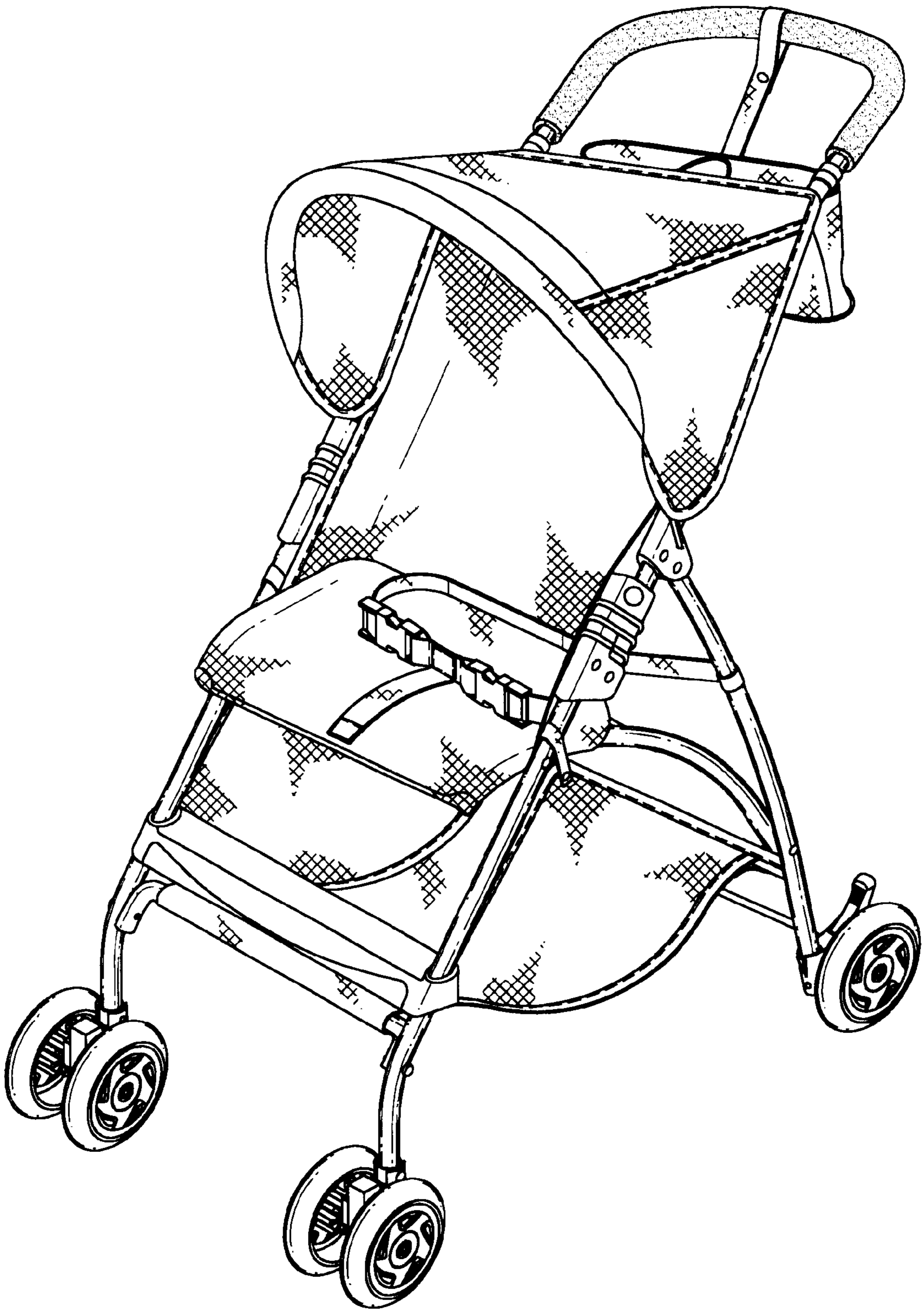

FIG. 1

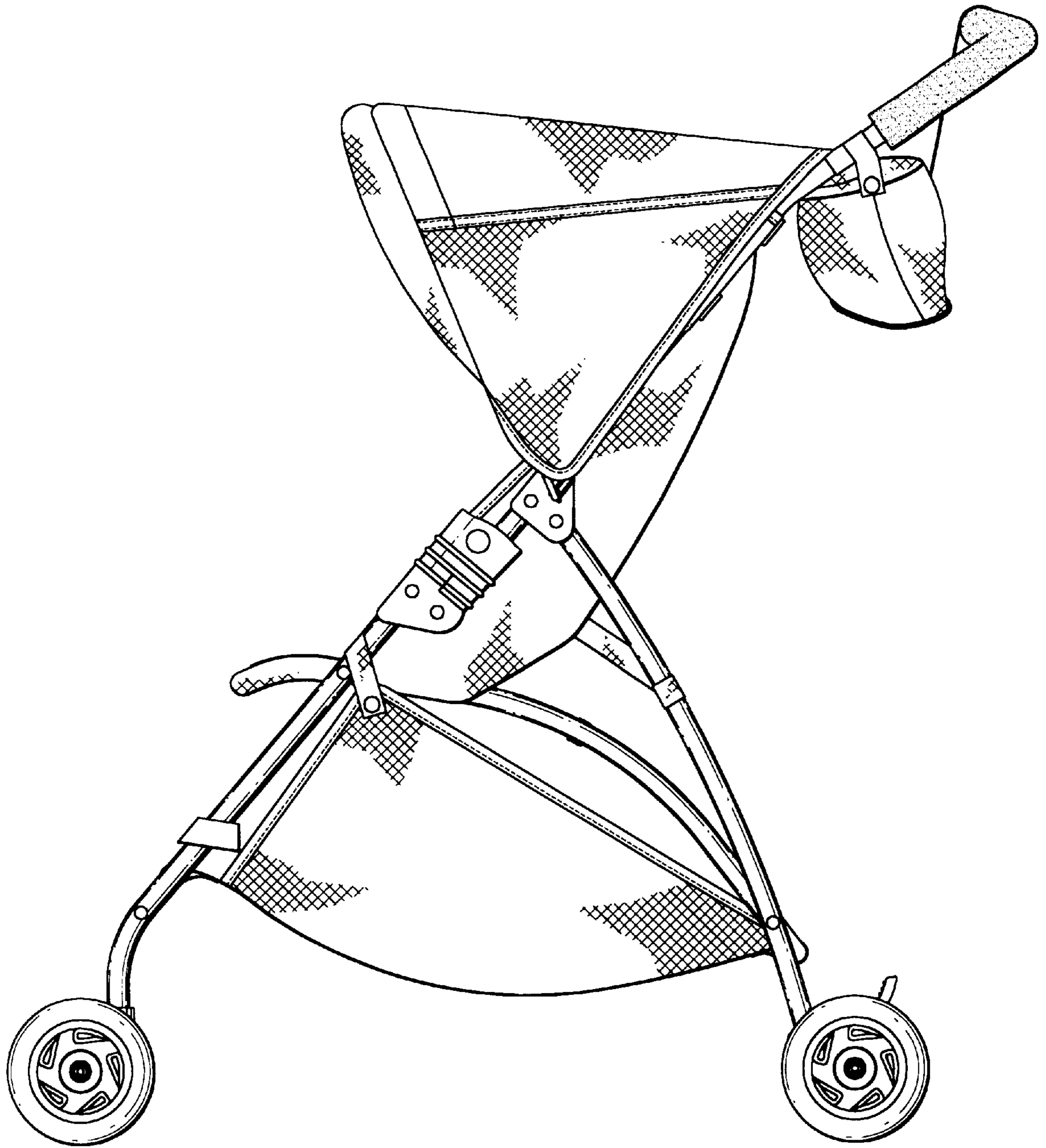

FIG. 2

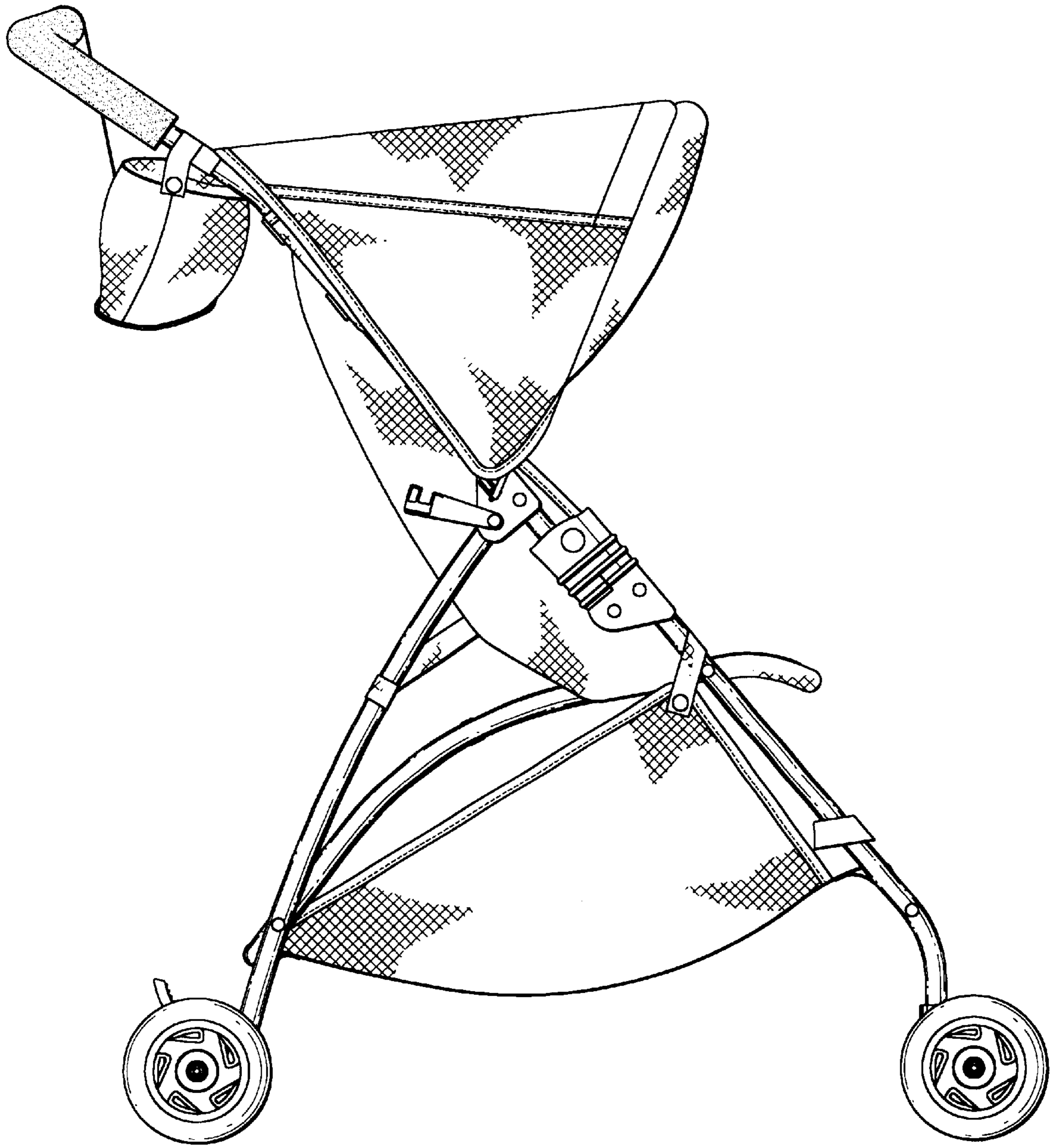

FIG. 3

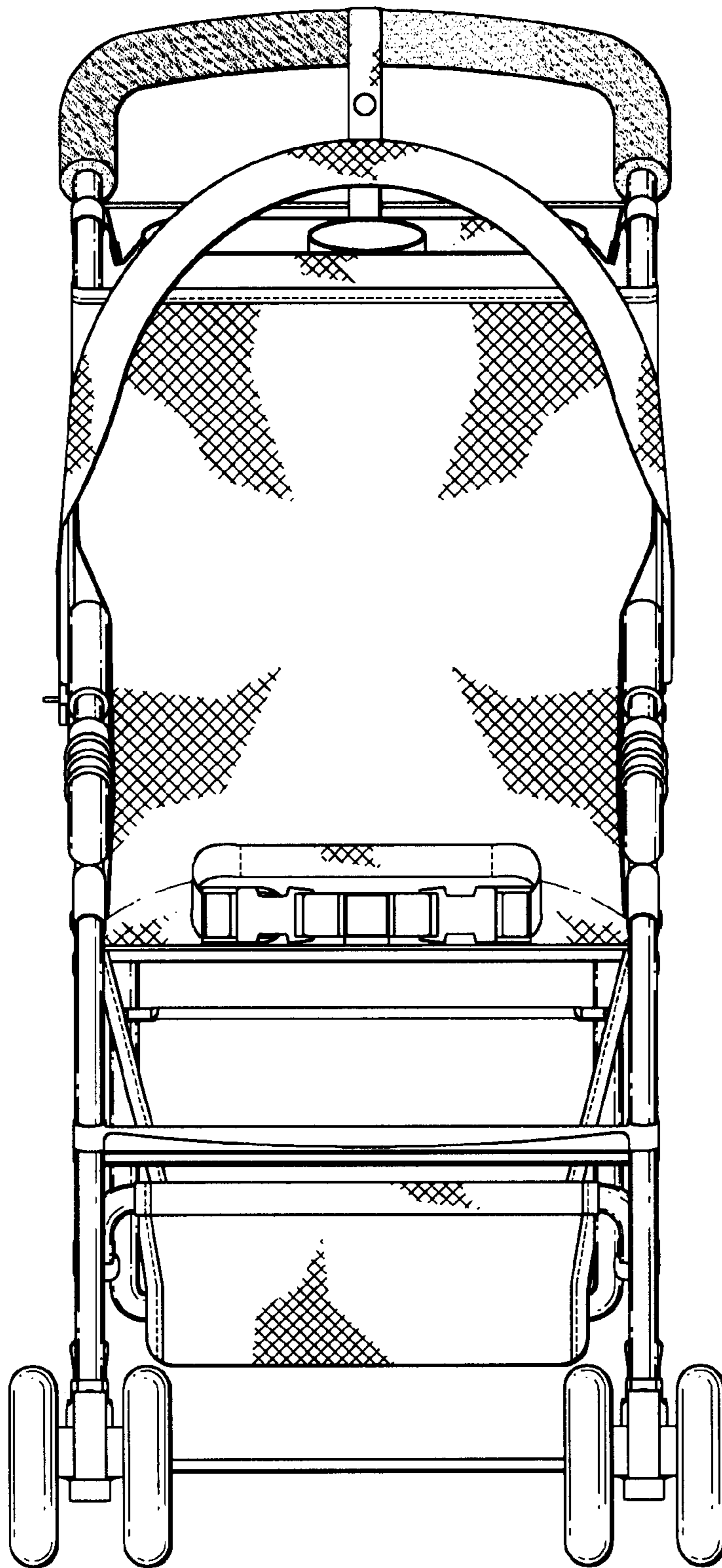

FIG. 4

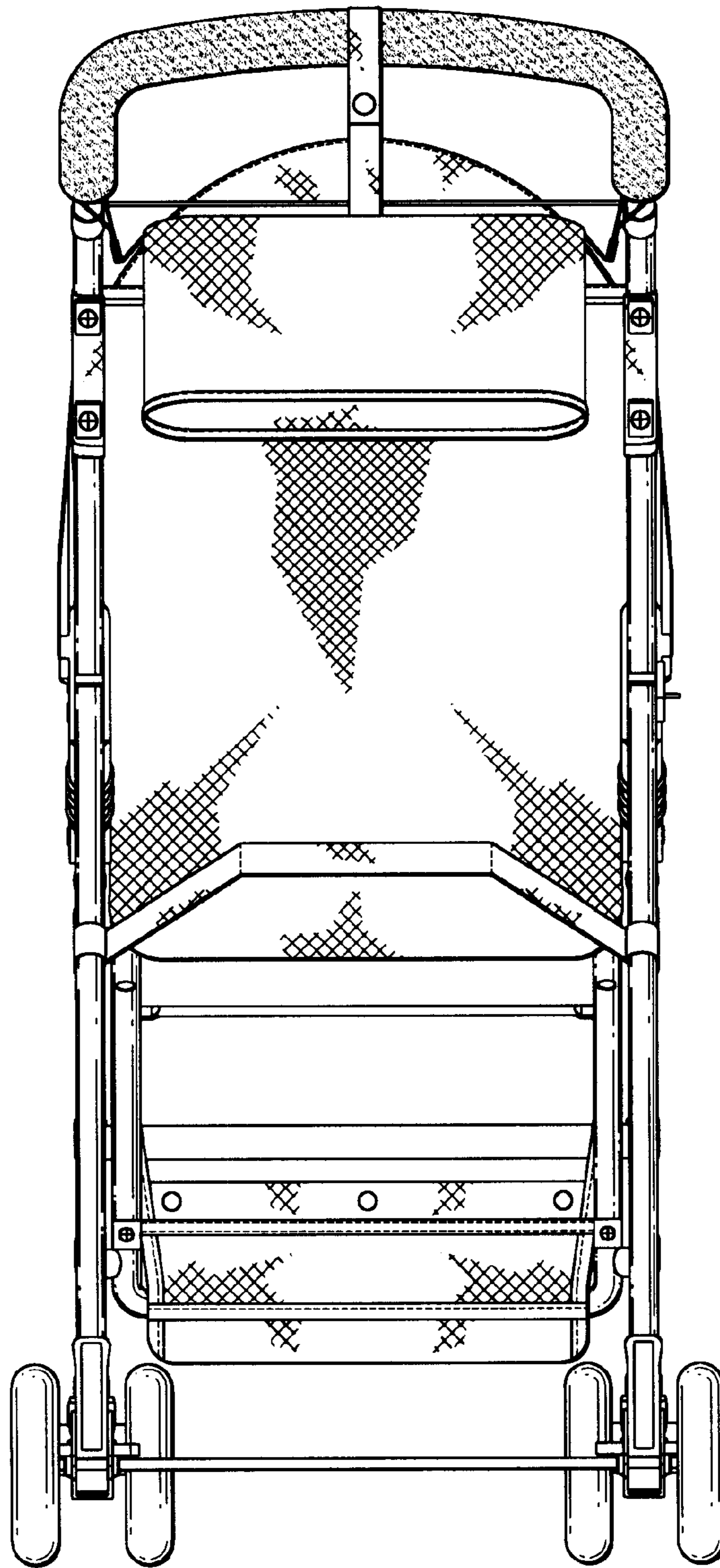

FIG. 5

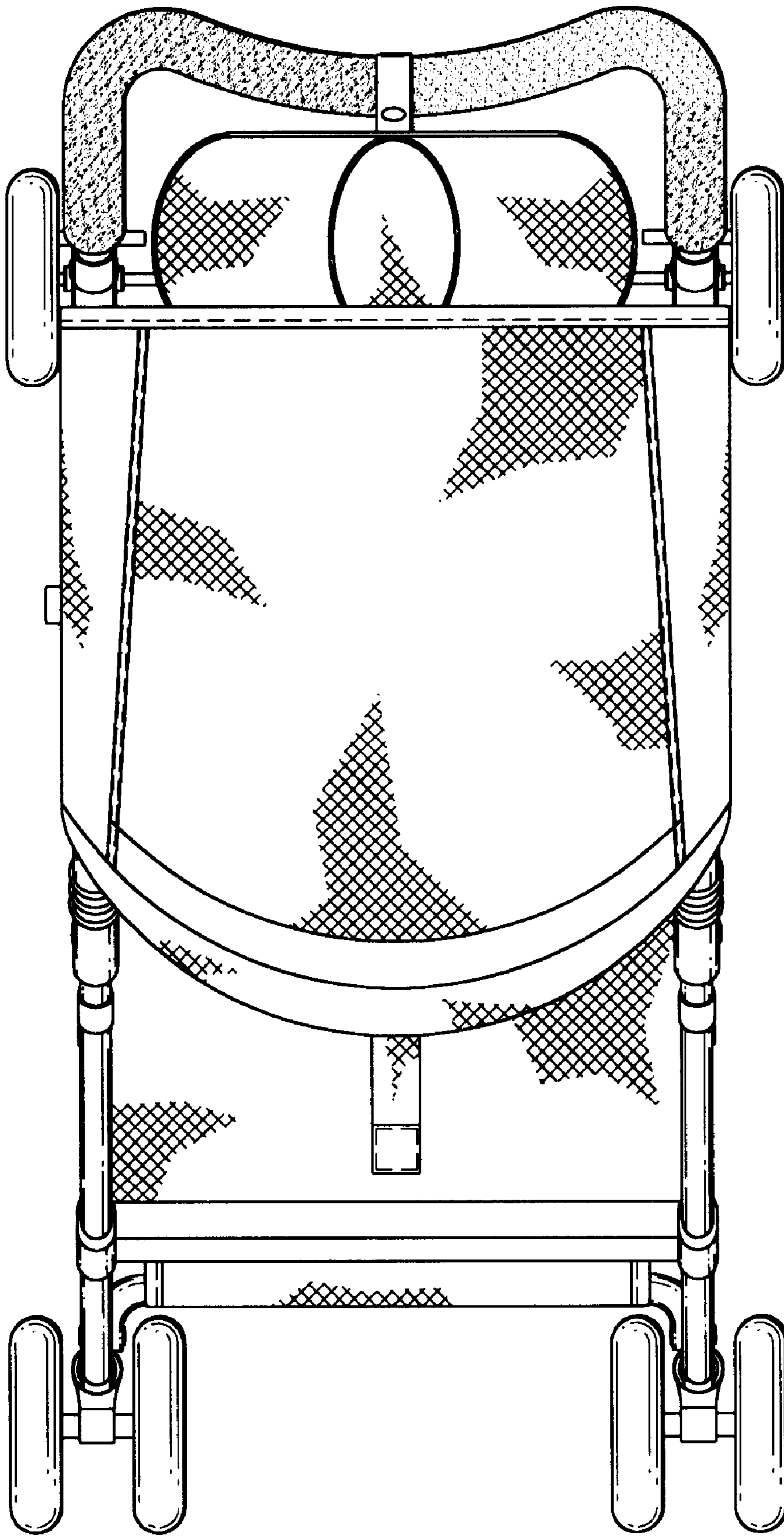

FIG. 6

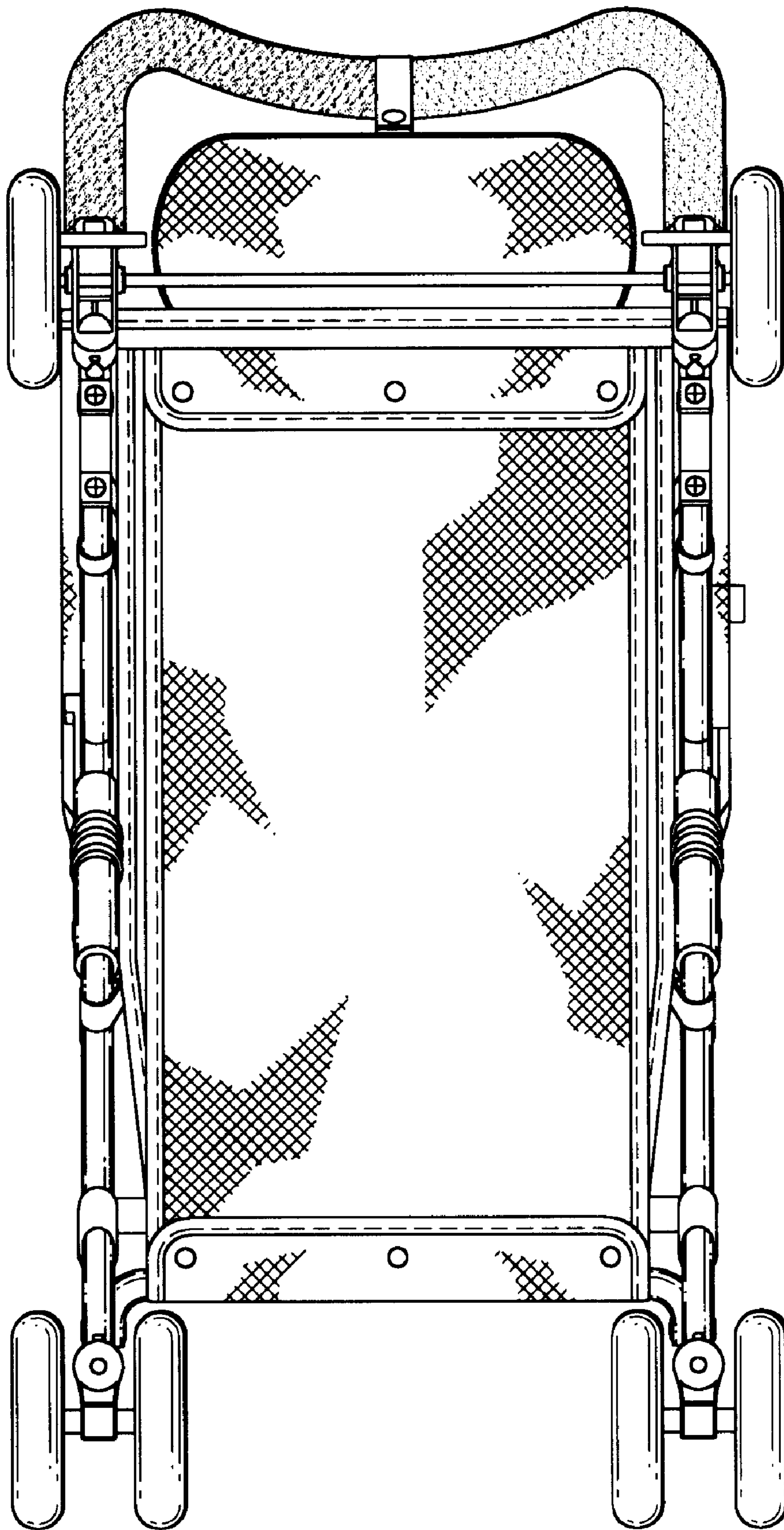

FIG. 7