



US00D484371S

(12) **United States Design Patent**
Tang et al.

(10) **Patent No.:** **US D484,371 S**

(45) **Date of Patent:** **** Dec. 30, 2003**

(54) **PEPPER GRINDER**

5,597,096 A * 1/1997 Jeppesen et al. 222/498
5,897,067 A * 4/1999 Tardif et al. 241/169.1

(75) Inventors: **Wing Sum Tang**, Kowloon (HK); **Yu Ying Tang**, Kowloon (HK)

* cited by examiner

(73) Assignee: **Samson Bright Industrial Company Limited**, Hong Kong (CN)

Primary Examiner—Terry A. Wallace

(74) *Attorney, Agent, or Firm*—Robert D. Katz; Cooper & Dunham LLP

(**) Term: **14 Years**

(57) **CLAIM**

(21) Appl. No.: **29/155,391**

The ornamental design for a pepper grinder, as shown and described.

(22) Filed: **Feb. 6, 2002**

(51) **LOC (7) Cl.** **07-06**

(52) **U.S. Cl.** **D7/679**

(58) **Field of Search** D7/679, 590–597,
D7/372, 373; 222/142.1–142.9, 480; 241/168,
169, 169.1, 262, 286

DESCRIPTION

FIG. 1 is a front perspective view of a pepper grinder showing my new design;
FIG. 2 is a front view thereof;
FIG. 3 is a left side view thereof;
FIG. 4 is a right side view thereof;
FIG. 5 is a rear view thereof;
FIG. 6 is a top plan view thereof; and,
FIG. 7 is a bottom plan view thereof.

(56) **References Cited**

U.S. PATENT DOCUMENTS

D187,040 S * 1/1960 Strauss D7/597
3,096,036 A * 7/1963 Cowles et al. 241/169

1 Claim, 4 Drawing Sheets

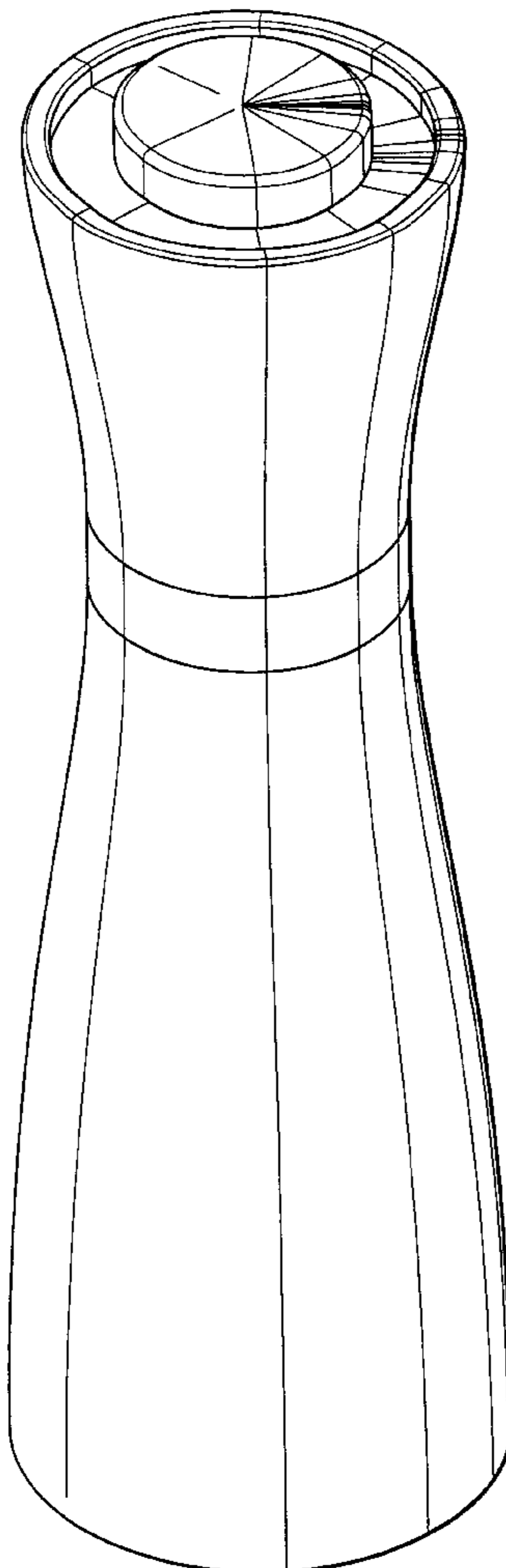

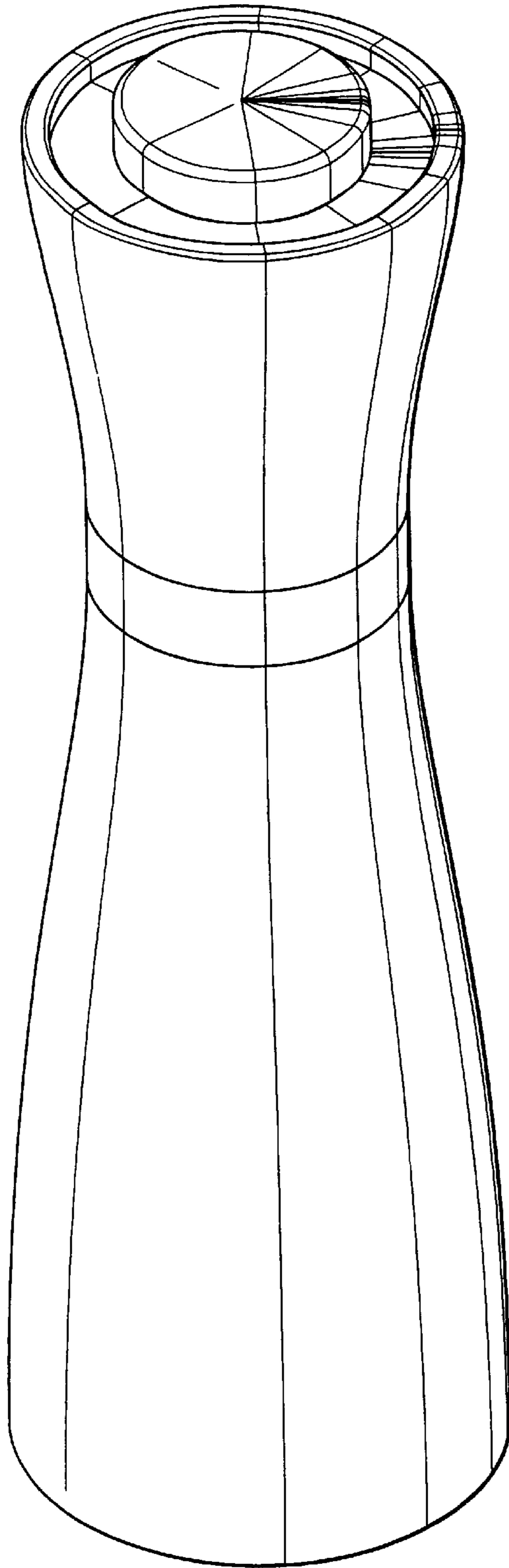

FIG. 1

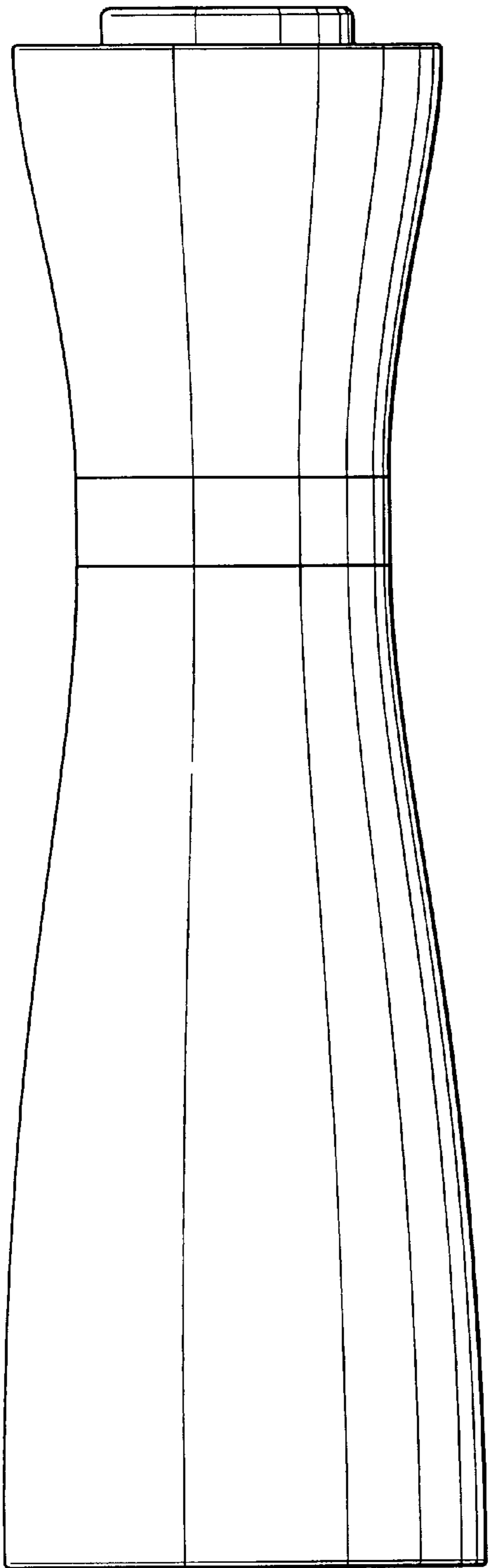

FIG. 3

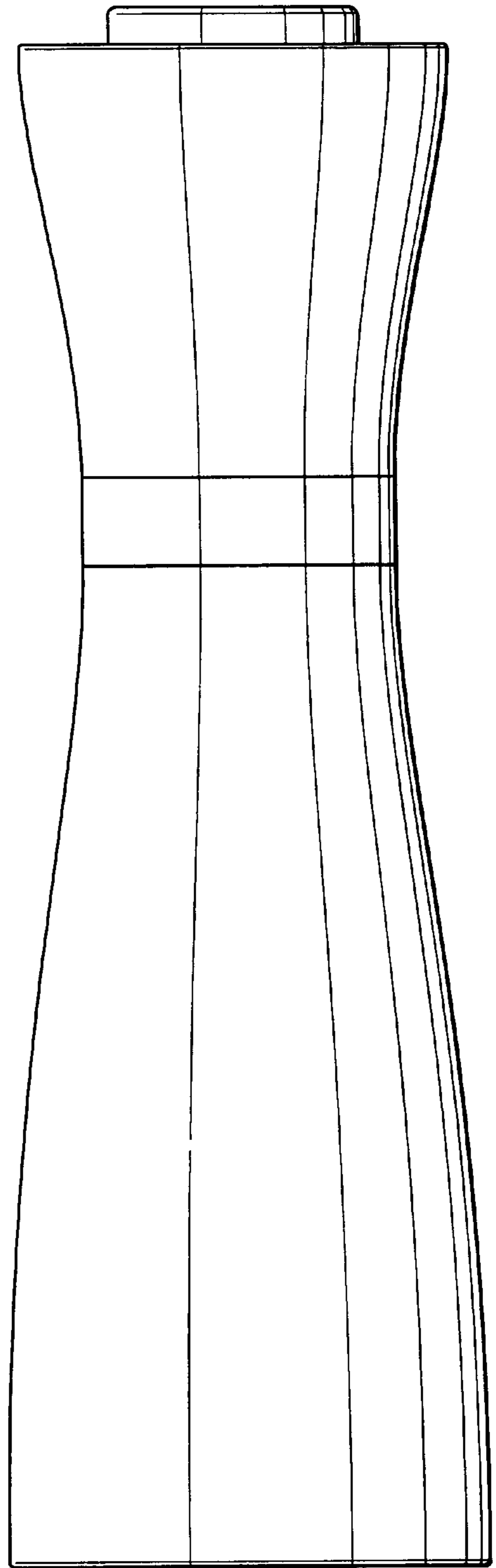

FIG. 2

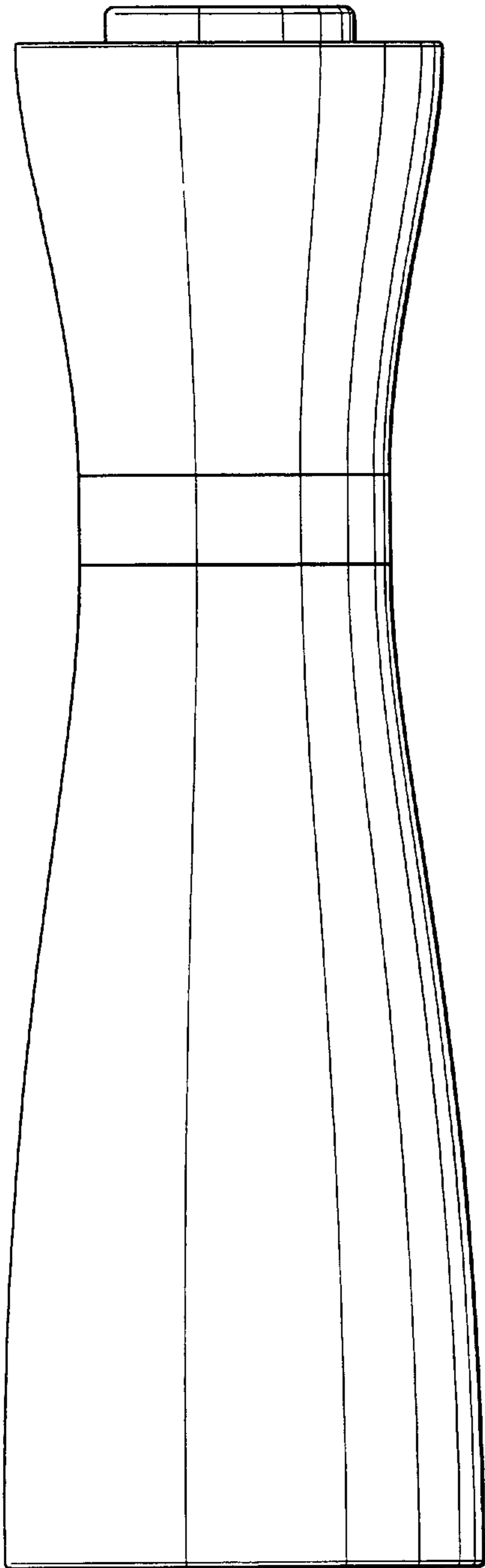

FIG. 5

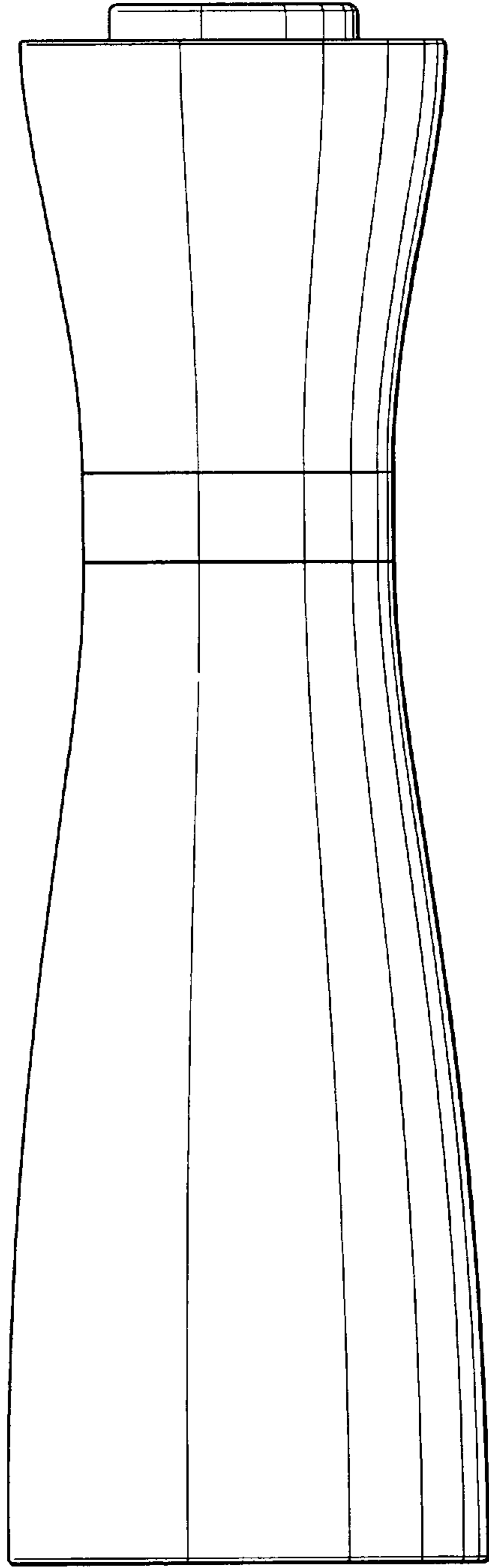

FIG. 4

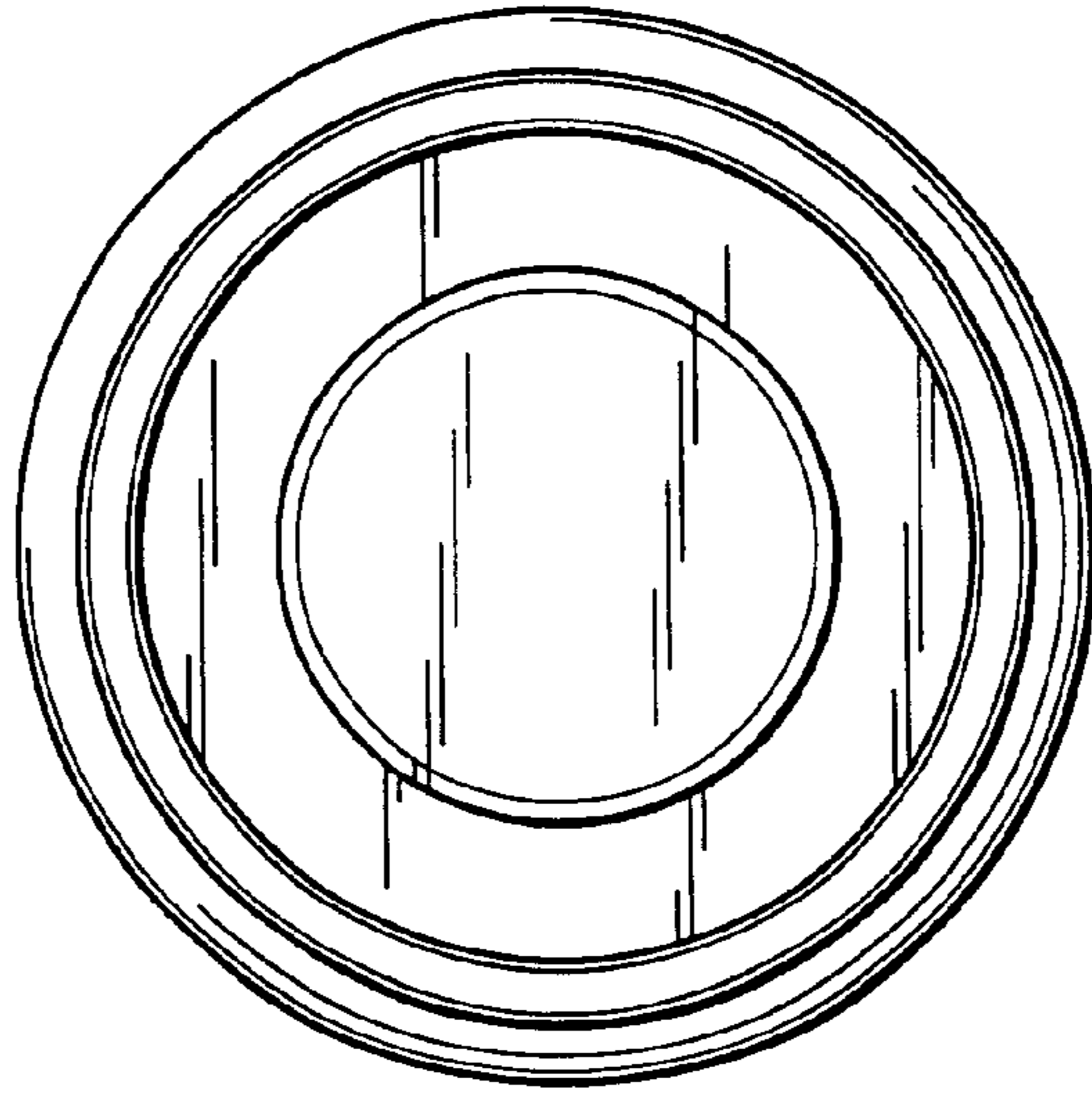

FIG. 6

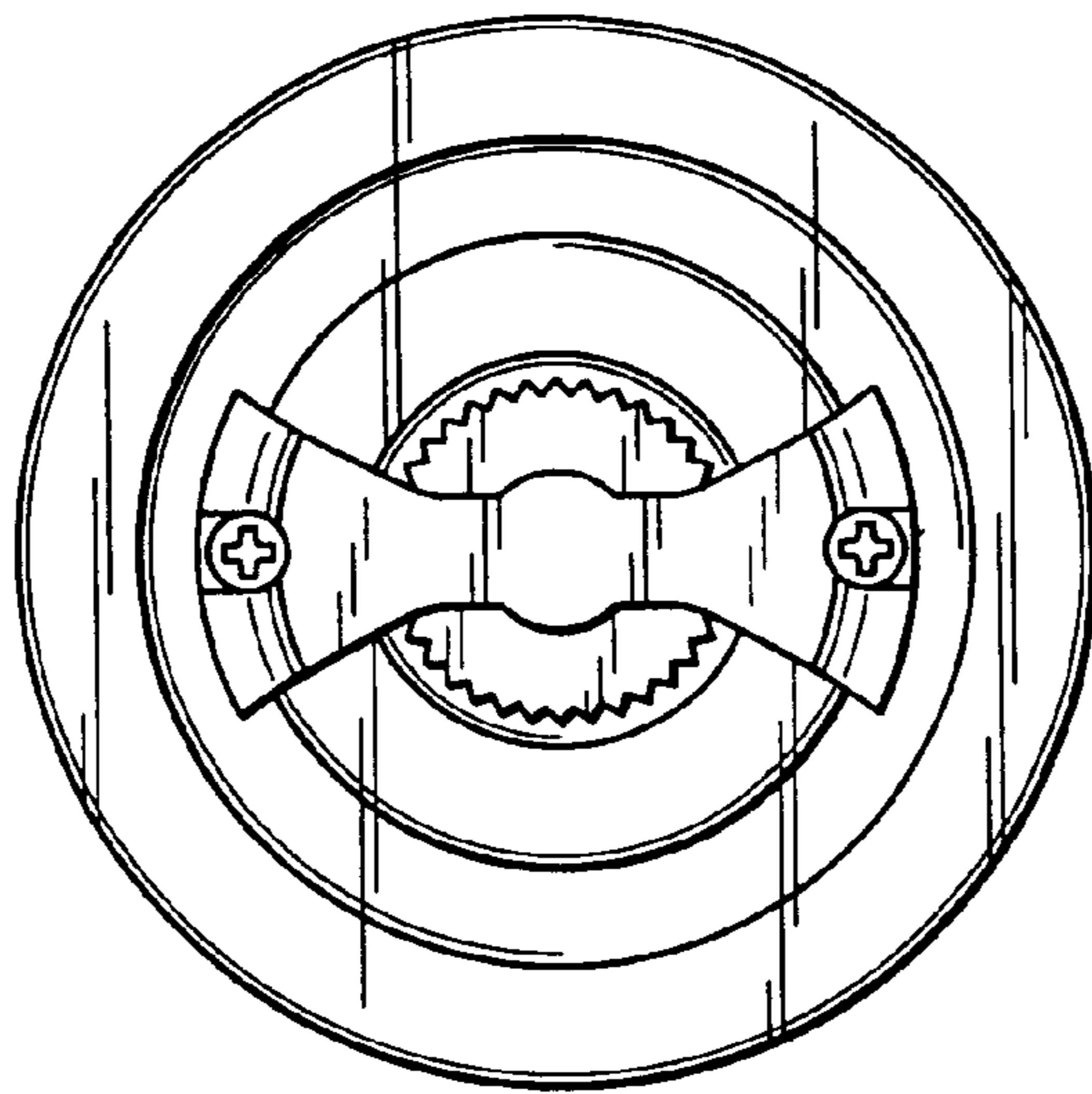

FIG. 7