



US00D484238S

(12) **United States Design Patent**
Radney et al.

(10) **Patent No.:** **US D484,238 S**

(45) **Date of Patent:** **** Dec. 23, 2003**

- (54) **PATIENT INTERFACE DEVICE**
- (75) Inventors: **Steven Radney**, Carnegie, PA (US);
Victor Ho Chi-wai, East Point (HK)
- (73) Assignee: **RIC Investments, Inc.**, Wilmington,
DE (US)
- (**) Term: **14 Years**

- 5,540,223 A 7/1996 Starr et al.
- 5,560,354 A 10/1996 Berthon-Jones et al.
- 5,647,357 A 7/1997 Barnett et al.
- 5,662,101 A 9/1997 Ogden et al.
- 5,676,133 A 10/1997 Hickie et al.
- D389,238 S 1/1998 Kirk, III et al.
- 5,724,965 A 3/1998 Handke et al.
- 5,746,201 A 5/1998 Kidd
- D402,755 S 12/1998 Kwok
- 5,884,624 A 3/1999 Barnett et al.

(21) Appl. No.: **29/176,548**

(List continued on next page.)

(22) Filed: **Feb. 24, 2003**

FOREIGN PATENT DOCUMENTS

Related U.S. Application Data

WO WO 98-04310 2/1998

(63) Continuation-in-part of application No. 29/166,817, filed on
Sep. 4, 2002.

Primary Examiner—Ian Simmons

(74) *Attorney, Agent, or Firm*—Michael W. Haas

(51) **LOC (7) Cl.** **29-02**

(57) **CLAIM**

(52) **U.S. Cl.** **D24/110.4; D24/110.1**

The ornamental design for a patient interface device, as
shown and described.

(58) **Field of Search** D24/110.1, 110.4,
D24/164; 128/207.17, 206.27, 202.27, 204.11,
205.25, 207.13, 207.11, 207.12, 207.18,
206.21

DESCRIPTION

(56) **References Cited**

U.S. PATENT DOCUMENTS

- 2,011,733 A 8/1935 Shindel
- 2,104,016 A 1/1938 Biggs
- 2,254,854 A 9/1941 O'Connell
- 2,317,608 A 4/1943 Heidbrink
- 2,749,910 A 6/1956 Faulconer, Jr.
- 2,931,356 A 4/1960 Schwarz
- 2,939,458 A 6/1960 Lundquist
- 3,330,273 A 7/1967 Bennett
- 4,167,185 A 9/1979 Lewis
- 4,655,213 A 4/1987 Rapoport et al.
- 4,677,977 A 7/1987 Wilcox
- 4,739,755 A 4/1988 White et al.
- 4,907,584 A 3/1990 McGinnis
- 4,944,310 A 7/1990 Sullivan
- D333,015 S 2/1993 Farmer et al.
- 5,243,971 A 9/1993 Sullivan et al.
- D349,586 S 8/1994 Handke
- 5,492,116 A 2/1996 Scarberry et al.

FIG. 1 is a front perspective view of an embodiment of a patient interface device according to our new design;
FIG. 2 is a rear perspective view of the patient interface device shown in FIG. 1;
FIG. 3 is a front elevational view of the patient interface device shown in FIG. 1;
FIG. 4 is a rear elevational view of the patient interface device shown in FIG. 1;
FIG. 5 is a right side elevational view of the patient interface device shown in FIG. 1;
FIG. 6 is a left elevational side view of the patient interface device shown in FIG. 1;
FIG. 7 is a top plan view of the patient interface device shown in FIG. 1; and,
FIG. 8 is a bottom plan view of the patient interface device shown in FIG. 1.

The portions drawn in broken lines are shown for illustrative purposes only and form no part of the claimed design.

1 Claim, 7 Drawing Sheets

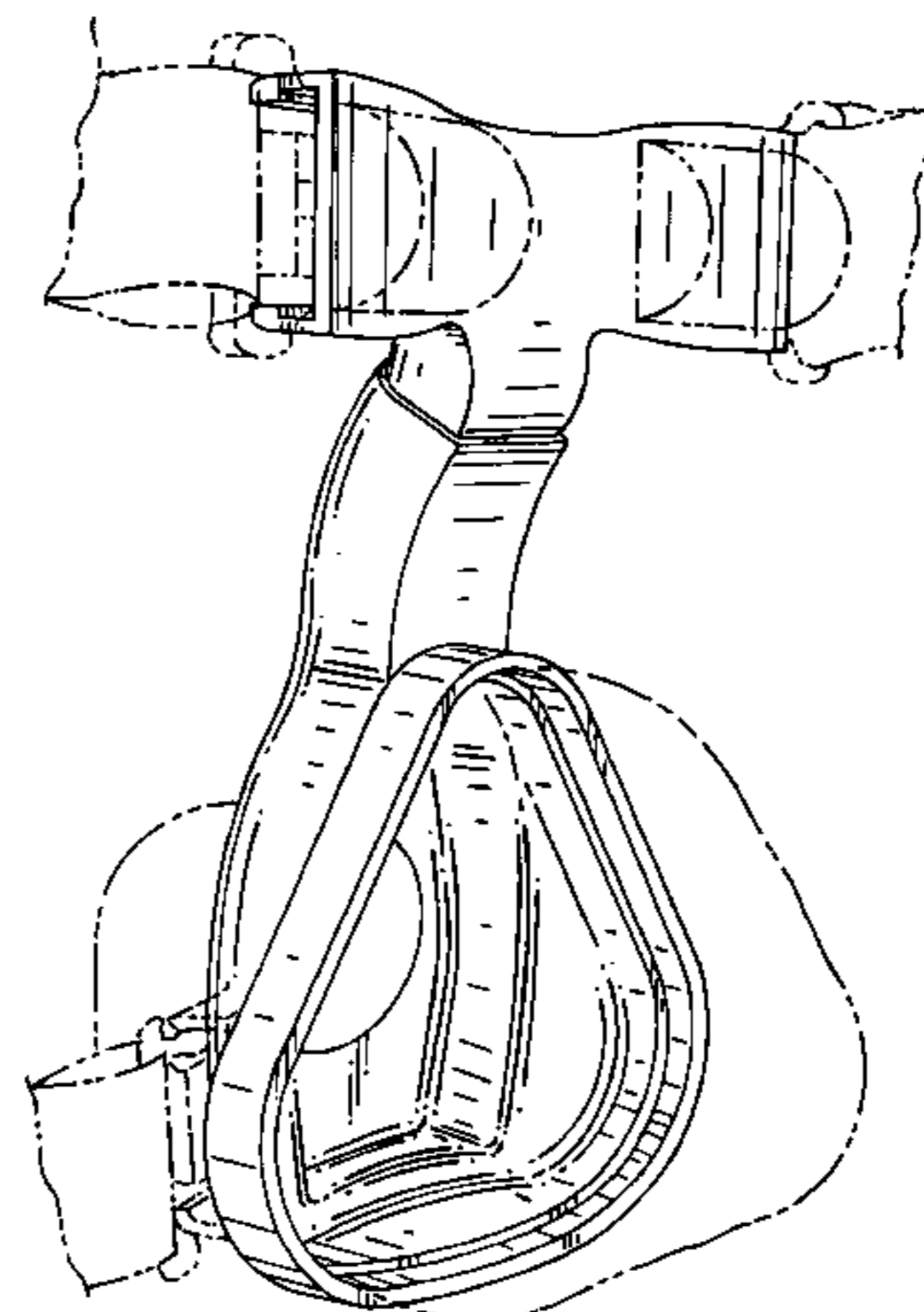
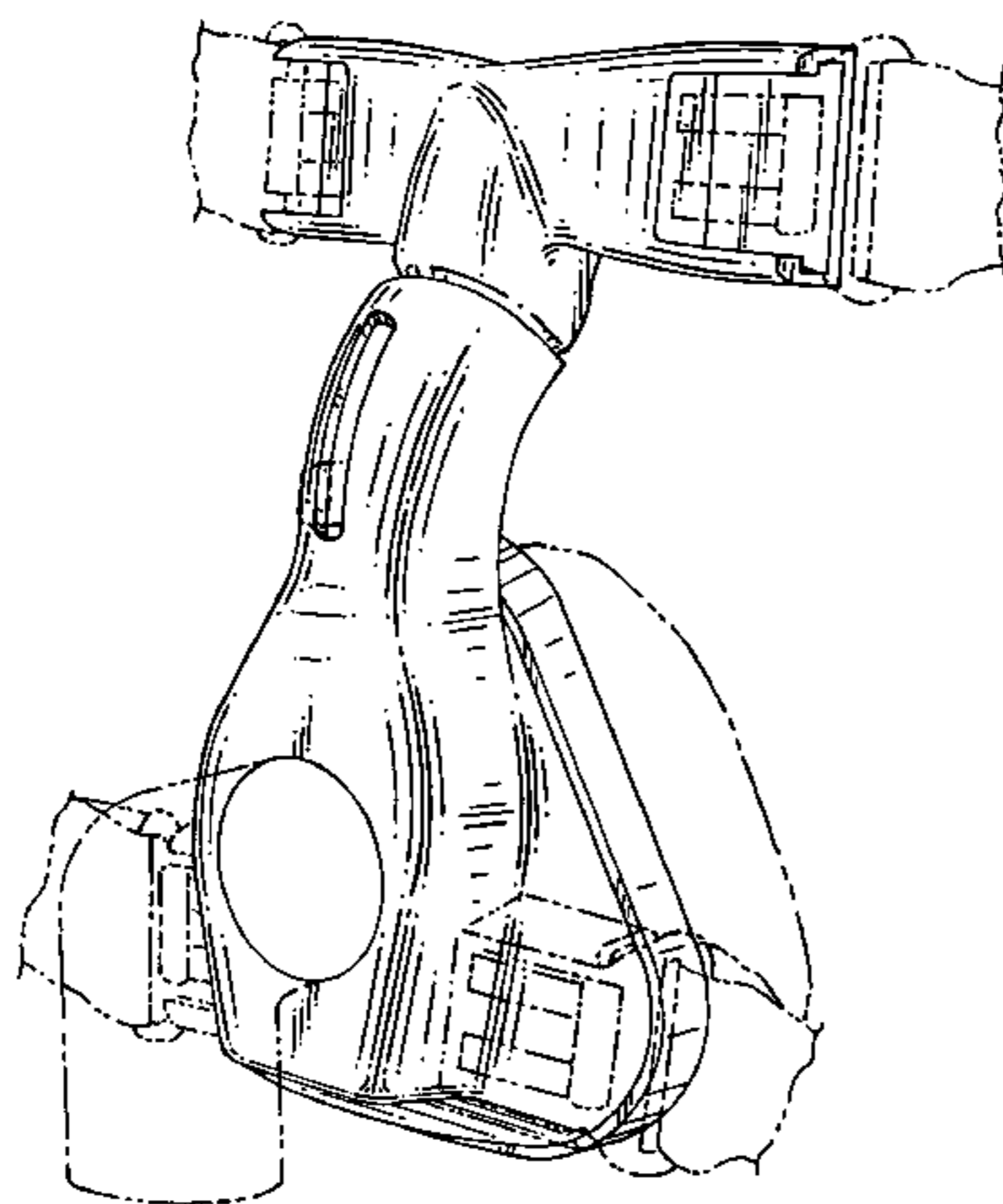

US D484,238 S

Page 2

U.S. PATENT DOCUMENTS

D412,745 S	8/1999	Scheu		D457,622 S	5/2002	Kopacko et al.	
D431,077 S	9/2000	McGinnis et al.		D458,365 S	6/2002	Kopacko et al.	
6,119,693 A *	9/2000	Kwok et al.	128/207.17	D459,993 S	6/2002	Kopacko et al.	
D434,141 S	11/2000	Randeberg et al.		D459,800 S	7/2002	Smart	
D439,326 S *	3/2001	Hecker et al.	D24/110.5	D468,421 S *	1/2003	Smart	D24/110.1
D443,355 S *	6/2001	Gunaratnam et al. ...	D24/110.4	D468,823 S *	1/2003	Smart	D24/110.1
D447,557 S	9/2001	Wilkie et al.		6,520,182 B1 *	2/2003	Gunaratnam	128/206.27
D448,473 S	9/2001	Barnett et al.		6,532,961 B1 *	3/2003	Kwok et al.	128/205.25

* cited by examiner

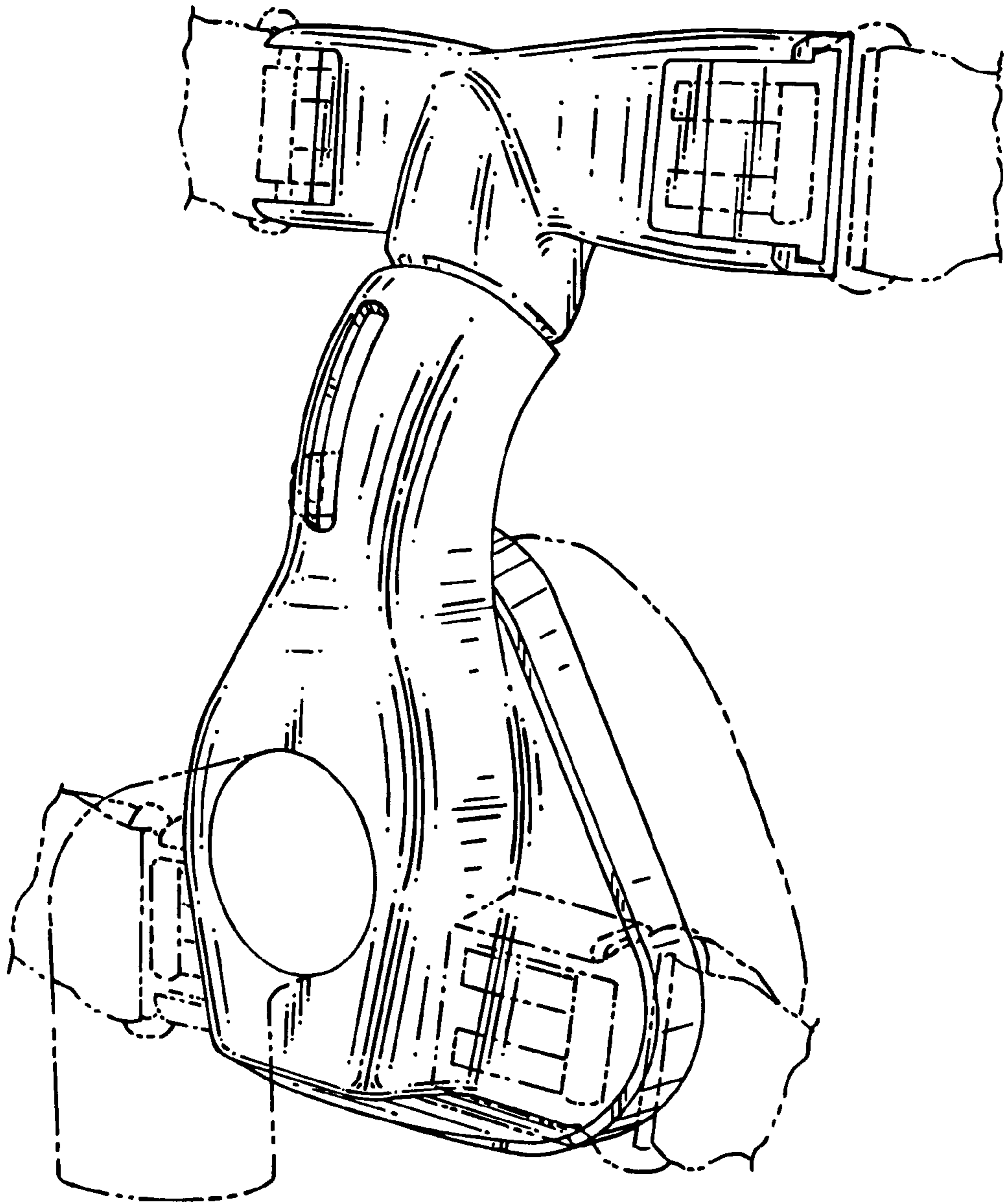

FIG. 1

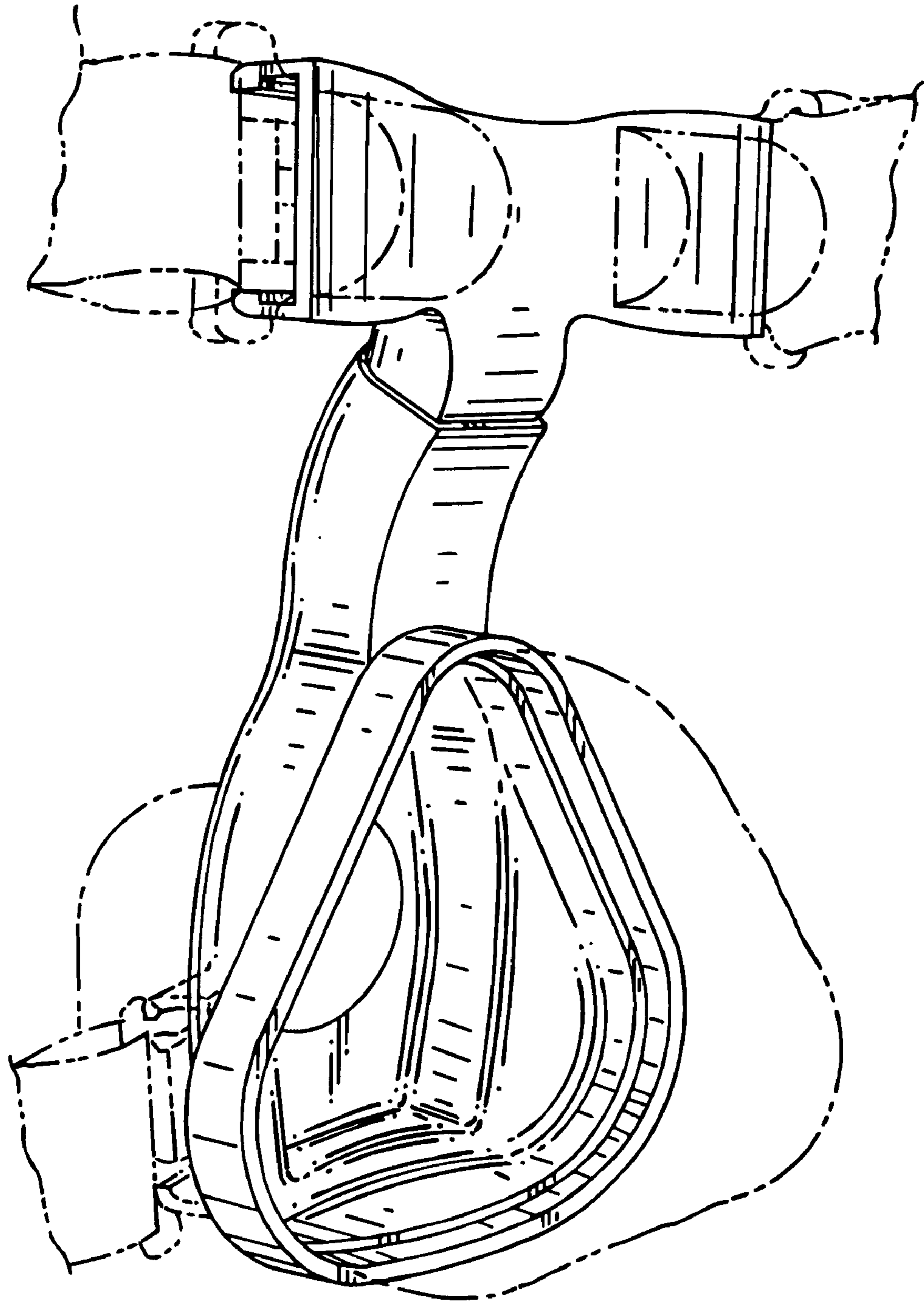

FIG. 2

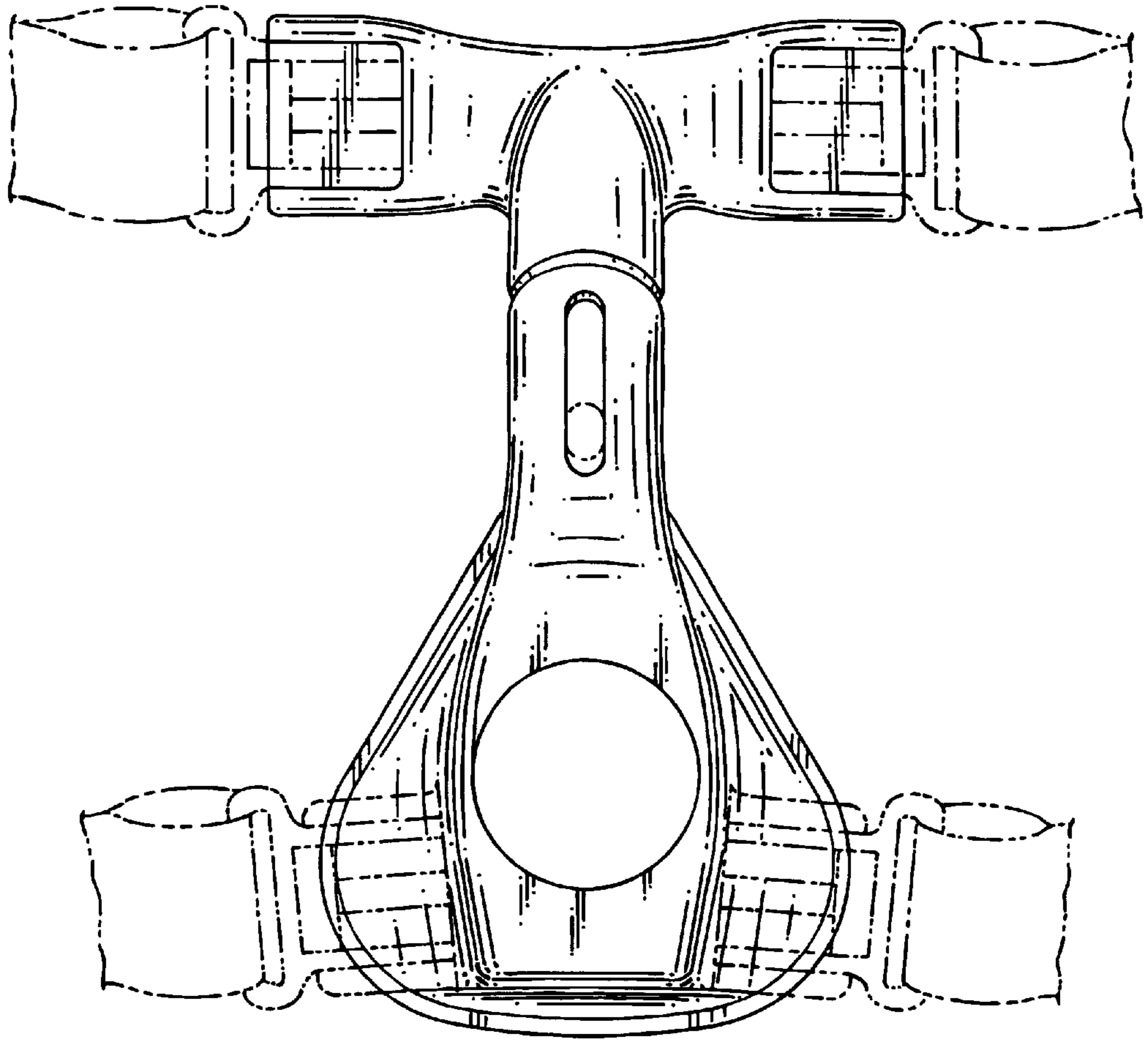

FIG. 3

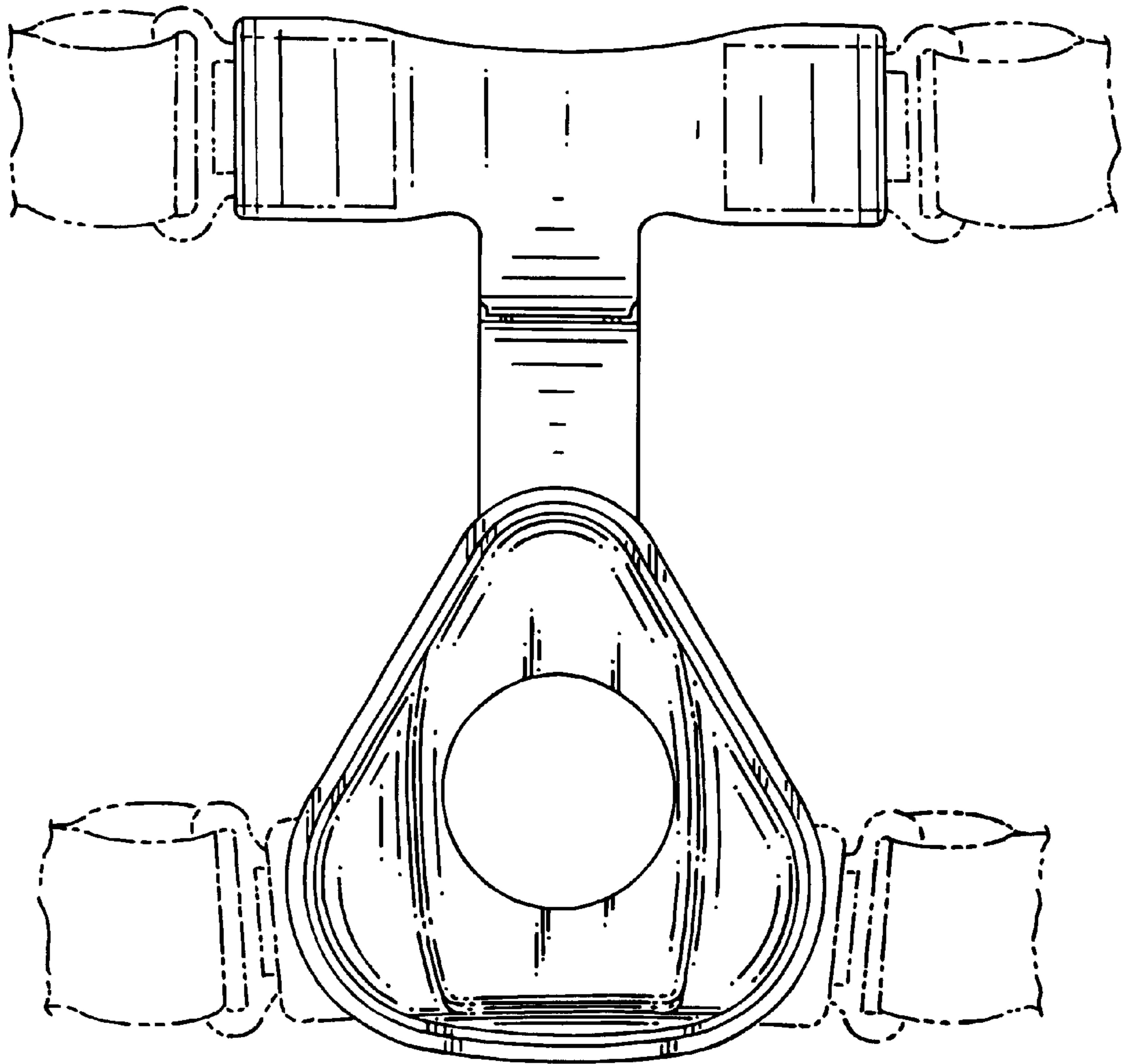

FIG. 4

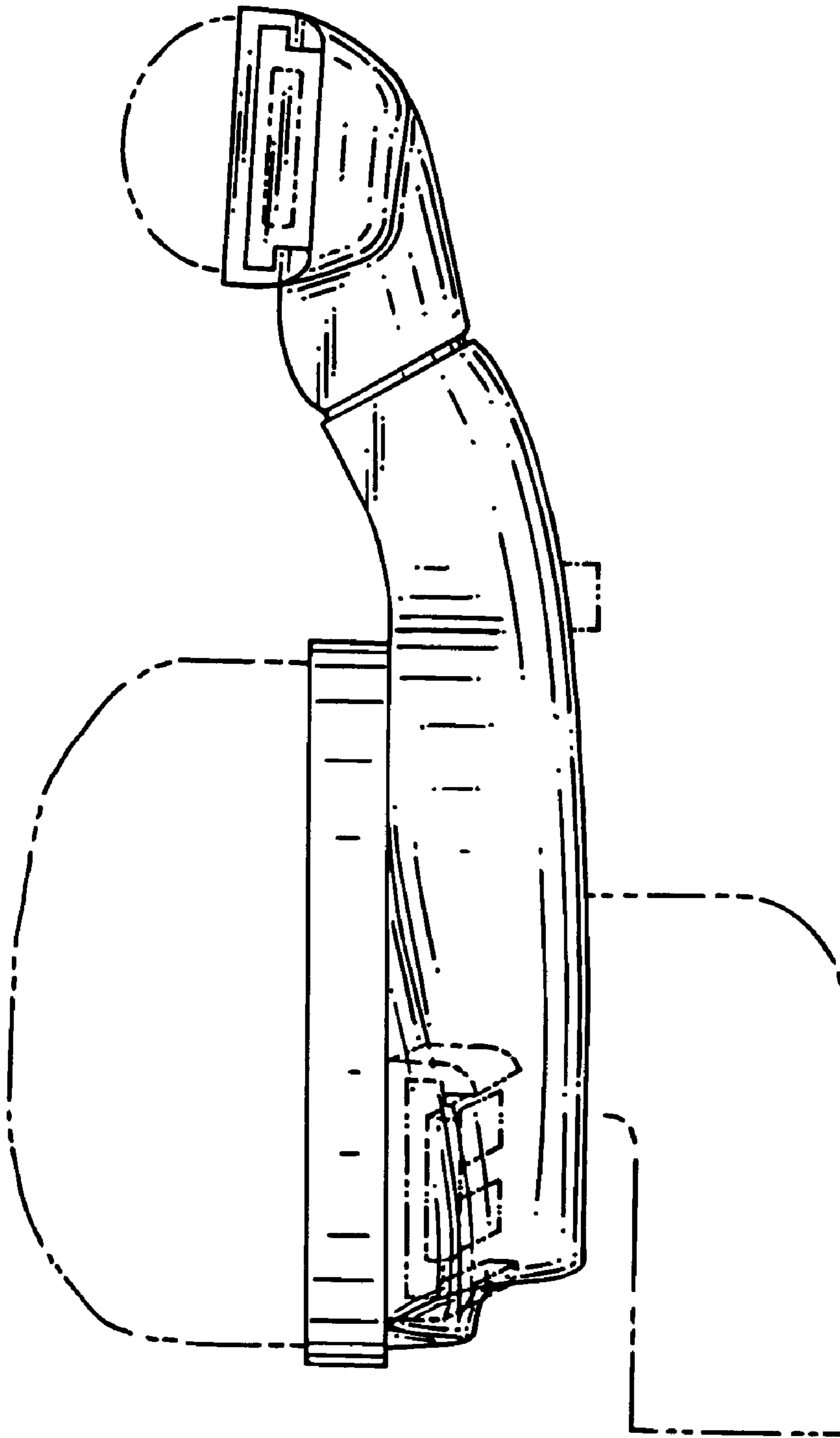

FIG. 5

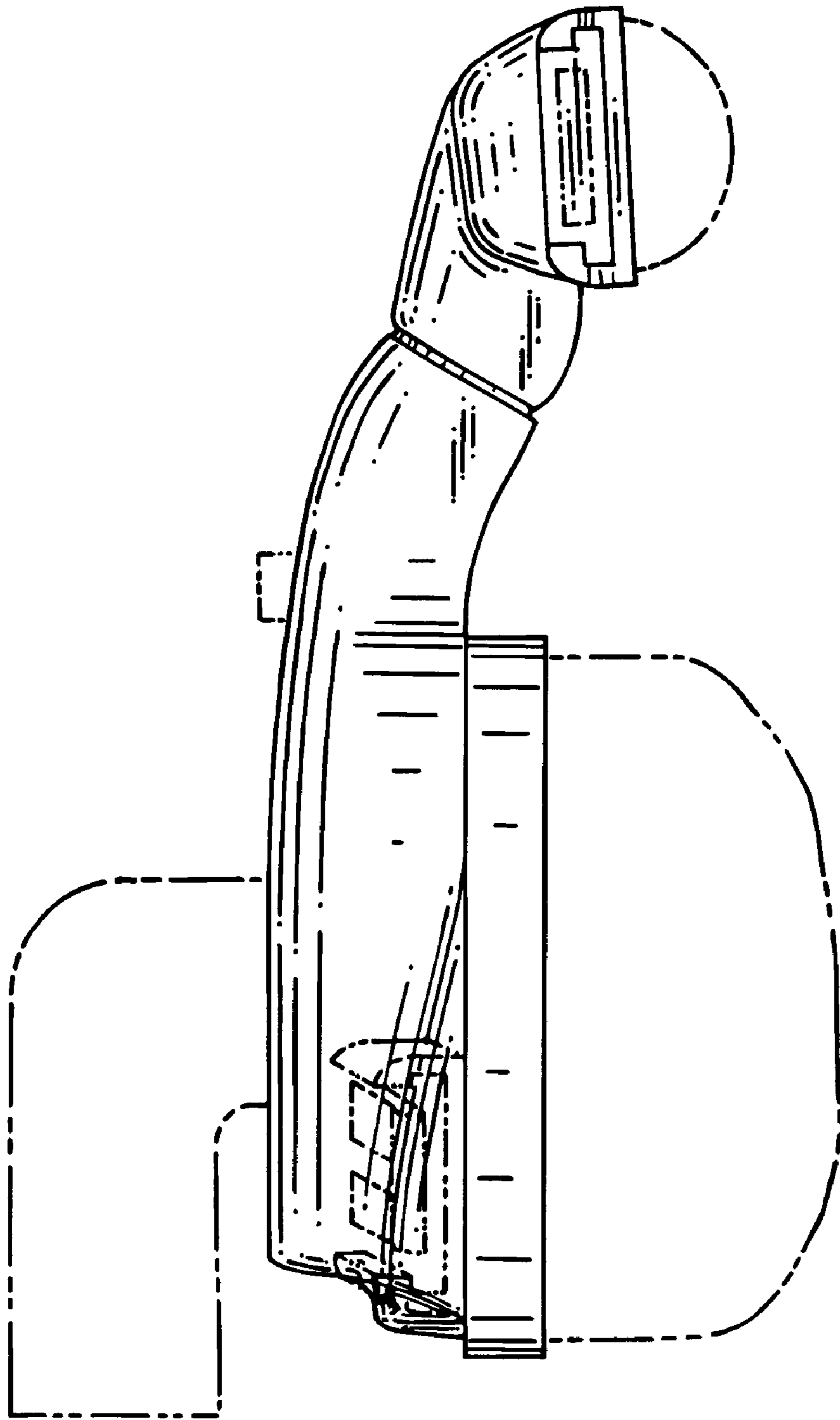

FIG. 6

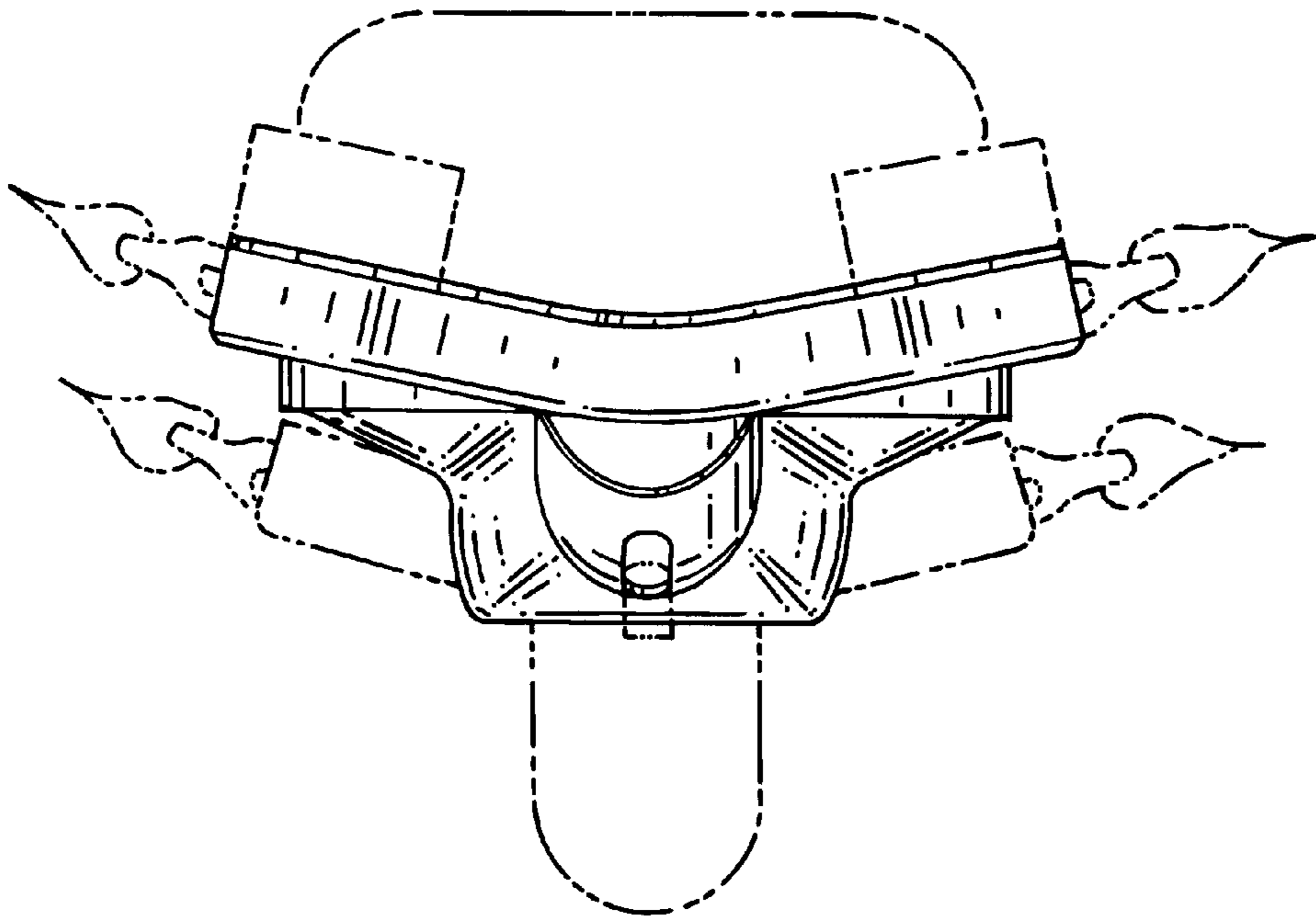

FIG. 7

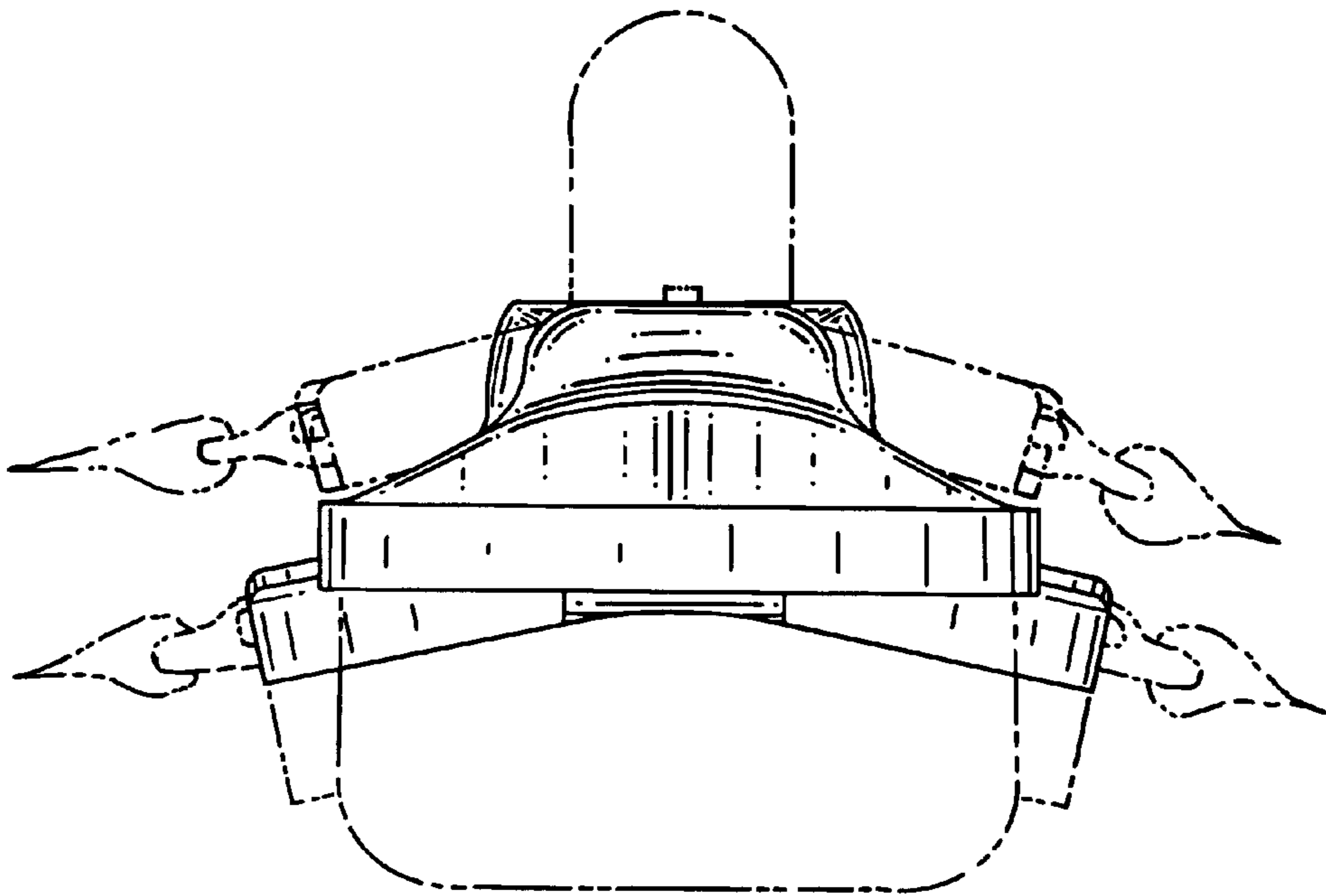

FIG. 8