



US00D484163S

(12) **United States Design Patent**
Kim

(10) **Patent No.:** **US D484,163 S**

(45) **Date of Patent:** **** Dec. 23, 2003**

(54) **CAP FOR PROTECTING THE TERMINAL OF A CAMERA FOR CELLULAR PHONES**

(75) Inventor: **Young Hoon Kim**, Kyungki-do (KR)

(73) Assignee: **Samsung Electro-Mechanics Co., Ltd.**
(KR)

(**) Term: **14 Years**

(21) Appl. No.: **29/154,549**

(22) Filed: **Jan. 24, 2002**

(51) **LOC (7) Cl.** **16-05**

(52) **U.S. Cl.** **D16/219; D13/154; D14/240**

(58) **Field of Search** **D3/208, 218; D13/154, D13/168; D14/130, 240, 432, 433, 454; D16/208, 219, 237**

(56) **References Cited**

U.S. PATENT DOCUMENTS

D299,126 S	*	12/1988	Johnson	D13/154
4,942,617 A	*	7/1990	Boylan	D14/240
D326,451 S	*	5/1992	Roegner	D14/138
D410,771 S	*	6/1999	Chang	D3/208
D427,170 S	*	6/2000	Edwards et al.	D14/138
D457,516 S	*	5/2002	Kohli et al.	D3/218

* cited by examiner

Primary Examiner—Adir Aronovich
(74) *Attorney, Agent, or Firm*—Webb Ziesenheim Logsdon Orkin & Hanson, P.C.

(57) **CLAIM**

The ornamental design for a cap for protecting the terminal of a camera for cellular phones, as shown and described.

DESCRIPTION

FIG. 1 is a perspective view (front and right side view) of a cap for protecting the terminal of a camera for cellular phones;

FIG. 2 is a front view thereof;

FIG. 3 is a rear view thereof;

FIG. 4 is a left side view thereof (the right side view thereof is a mirror image of this);

FIG. 5 is a top plan view thereof;

FIG. 6 is a bottom view thereof; and,

FIG. 7 is a perspective view thereof, showing the cap in use, whereas the camera and other portions shown in broken lines are to illustrate environment only and form no part of the claimed design.

1 Claim, 1 Drawing Sheet

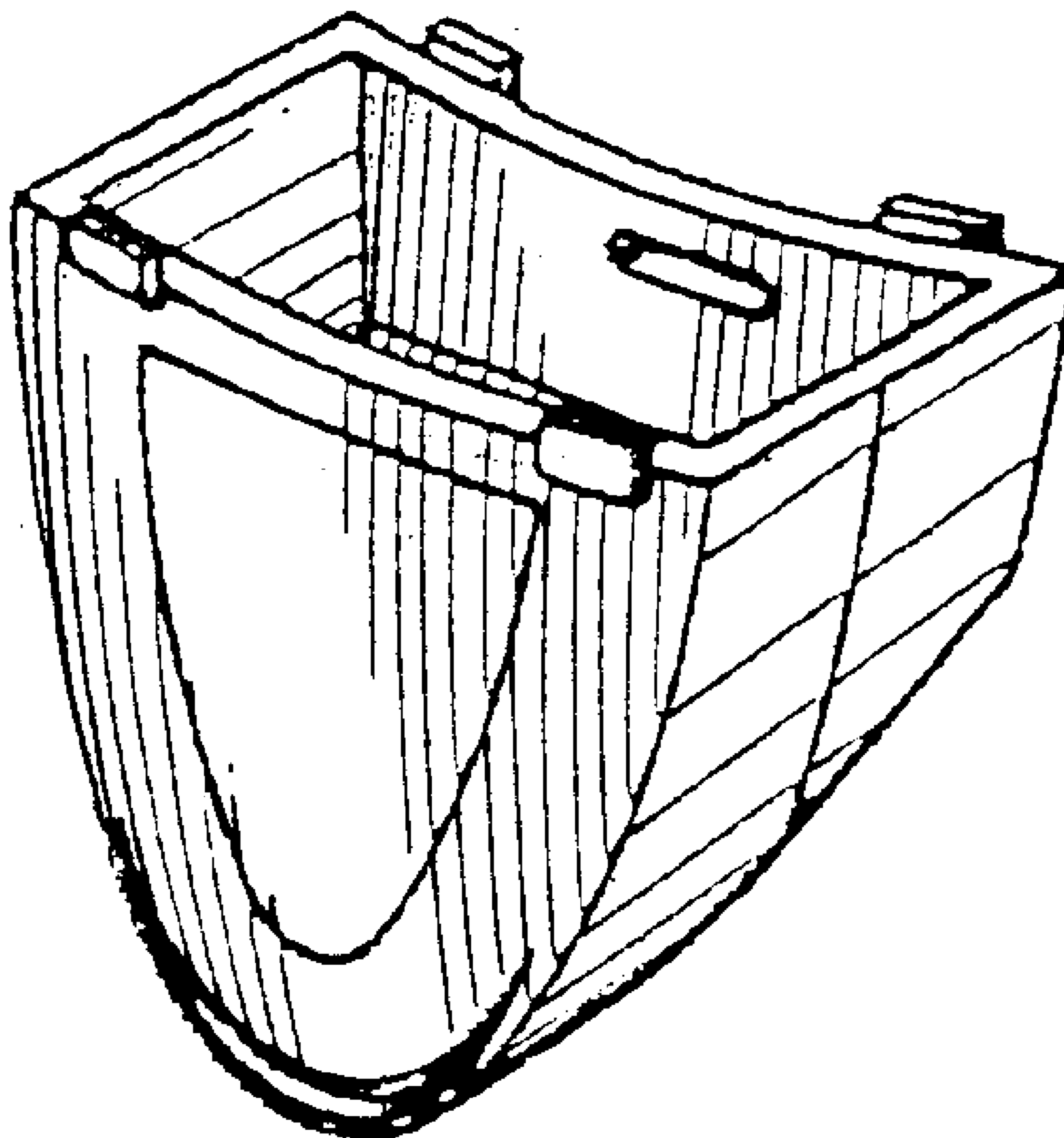

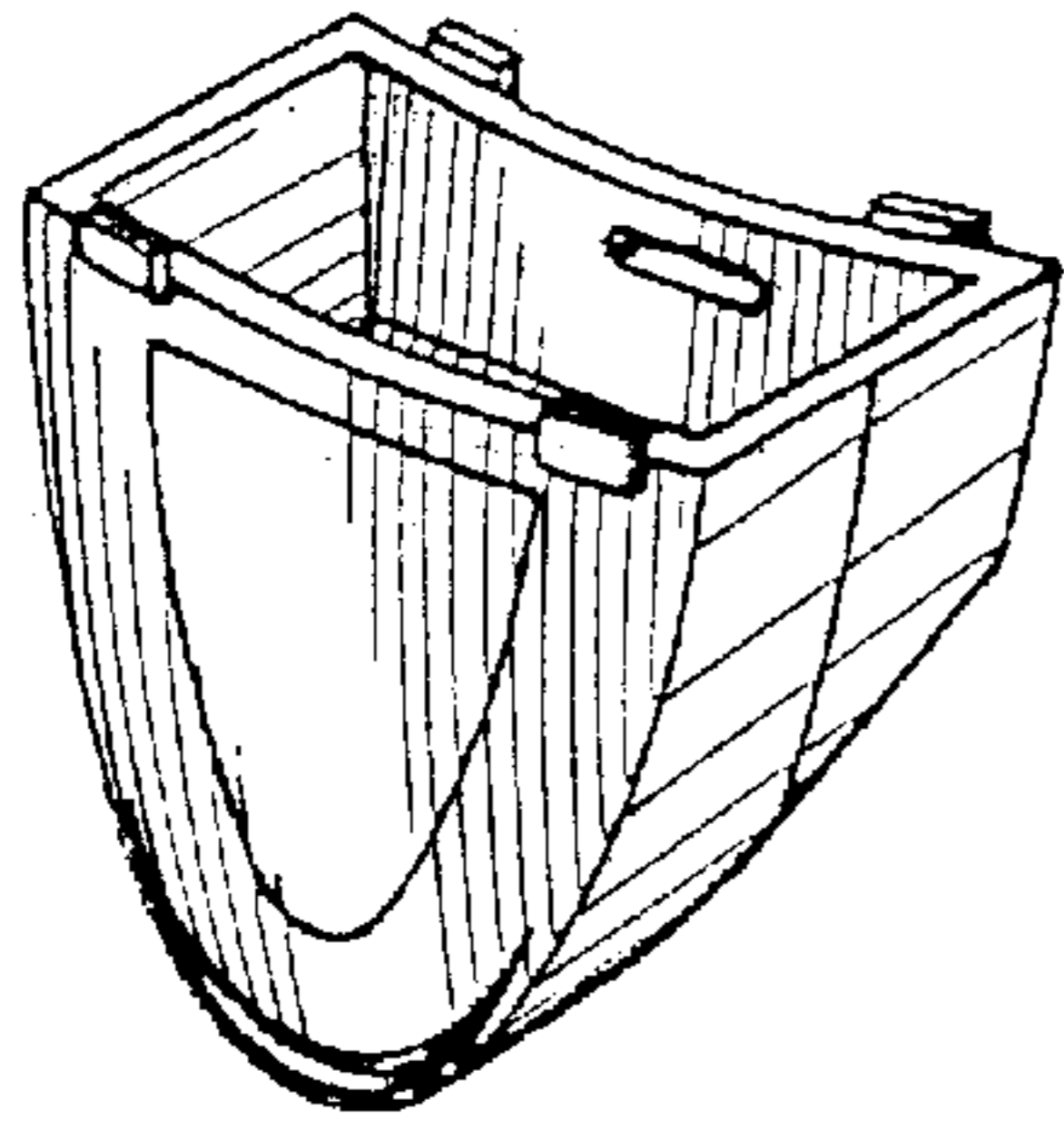

FIG. 1

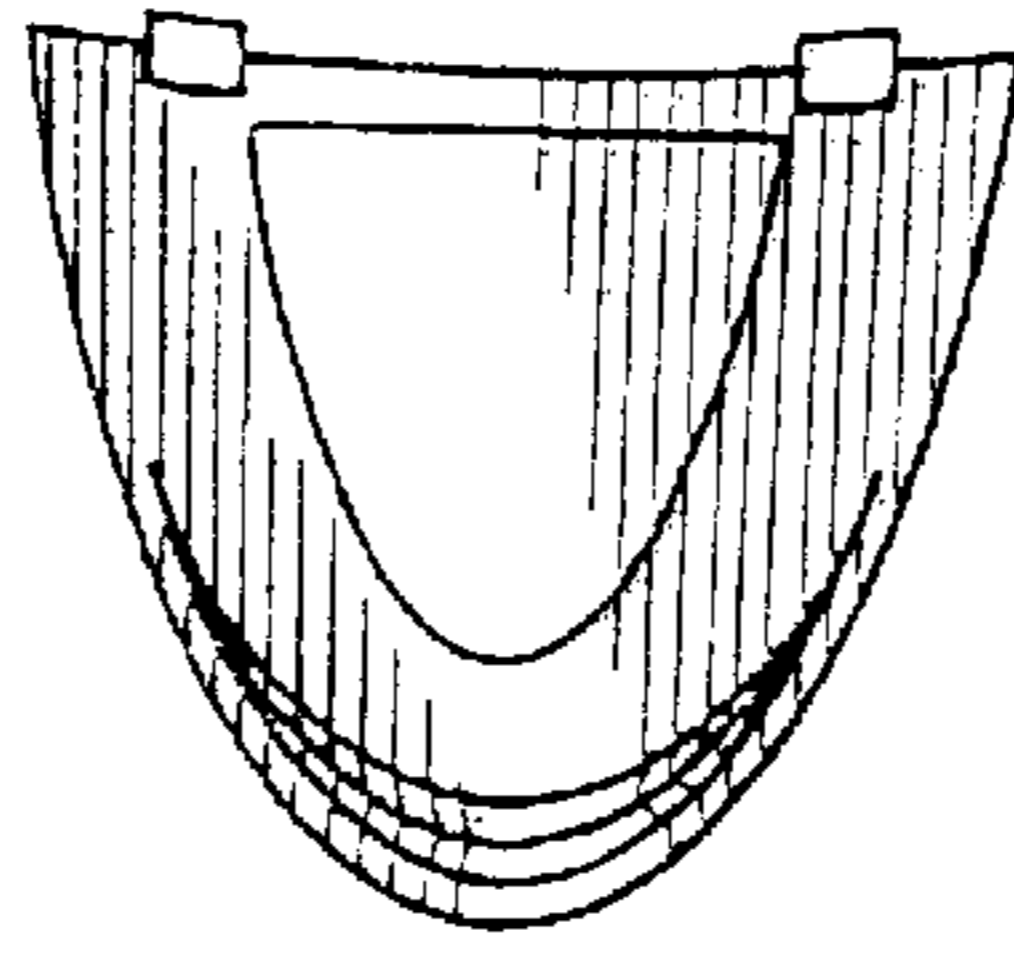

FIG. 2

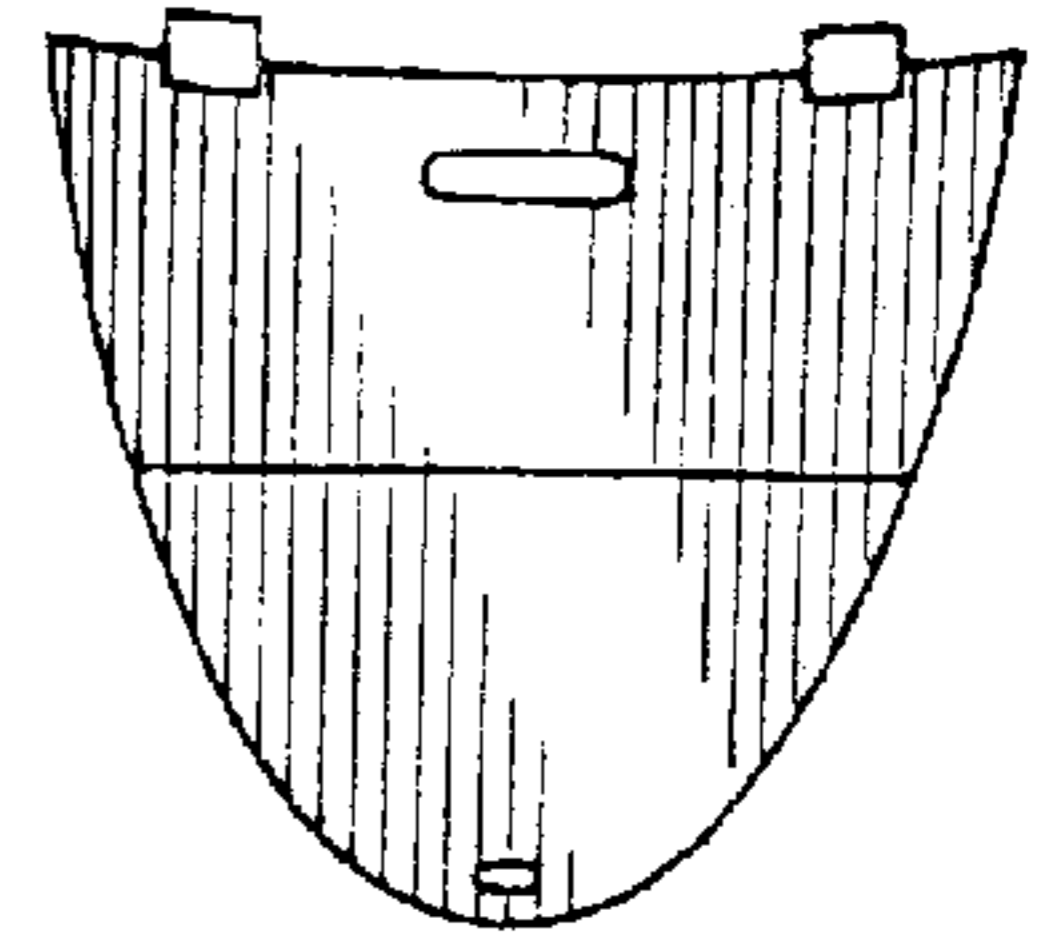

FIG. 3

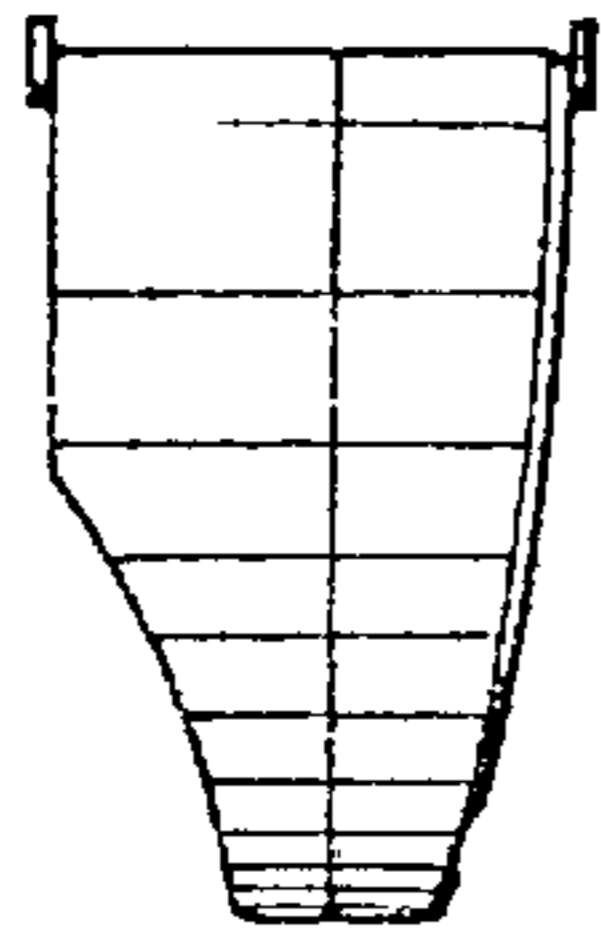

FIG. 4

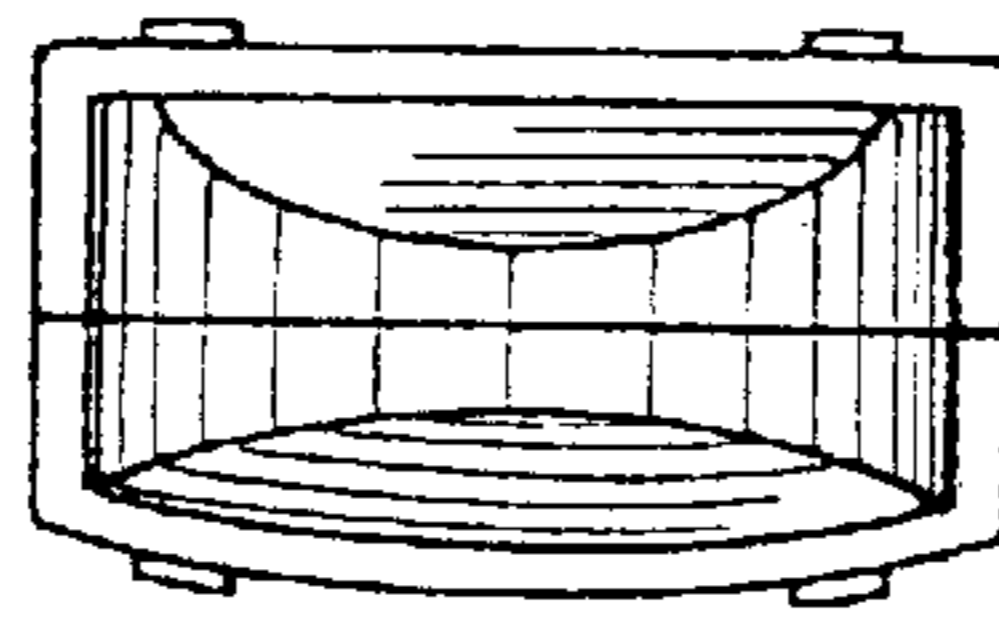

FIG. 5

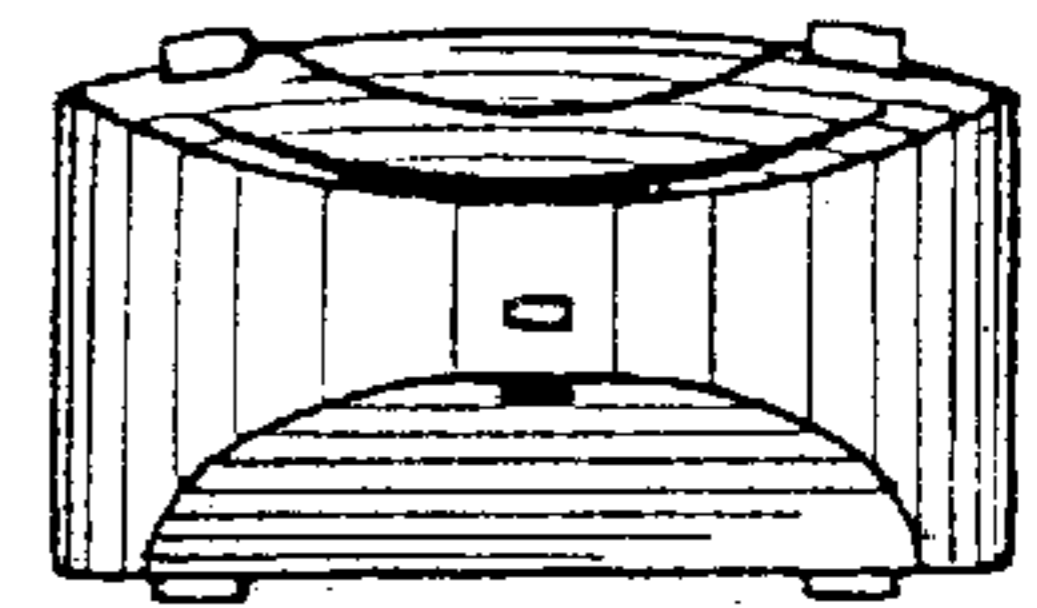

FIG. 6

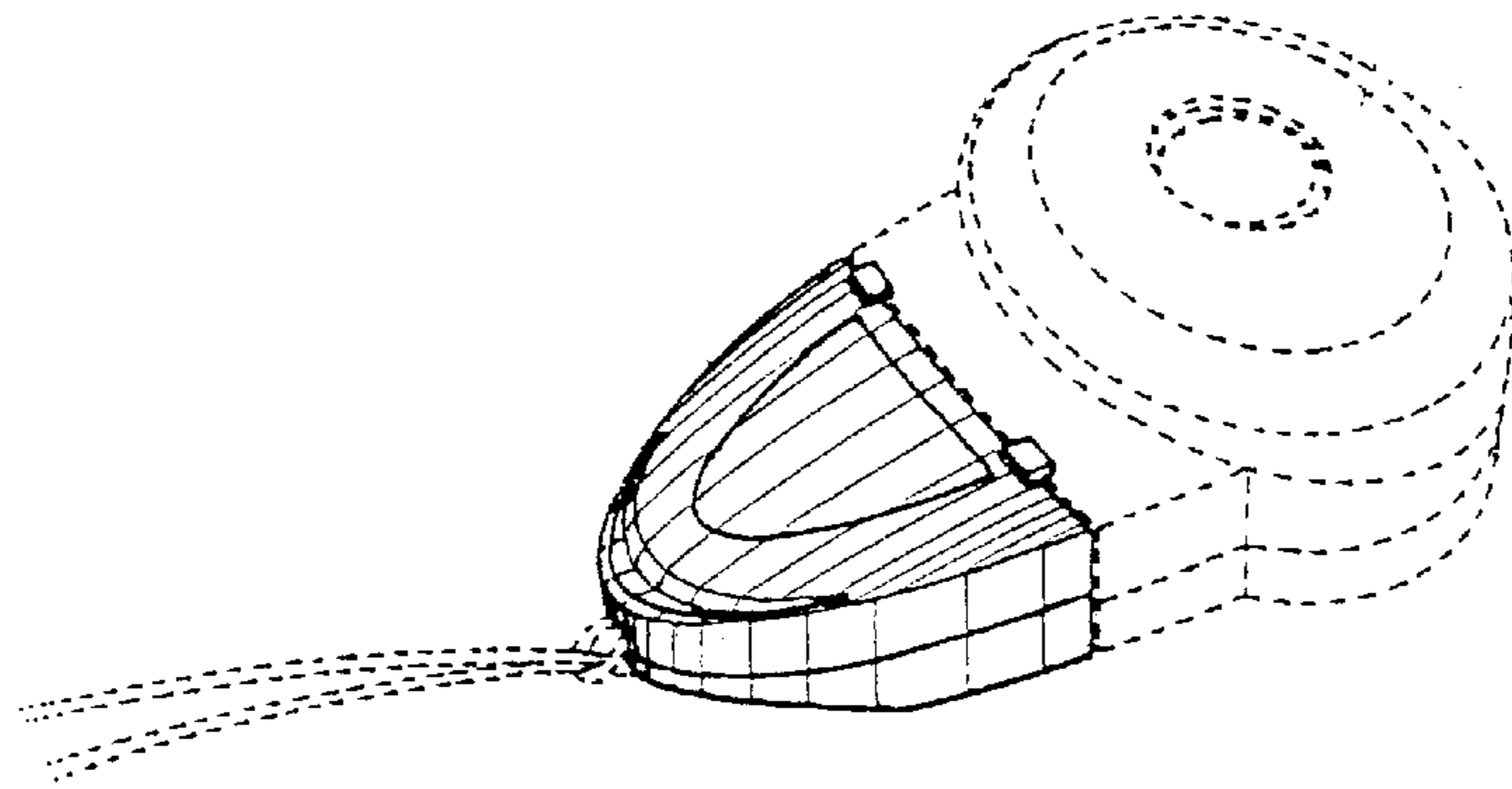

FIG. 7

UNITED STATES PATENT AND TRADEMARK OFFICE
CERTIFICATE OF CORRECTION

PATENT NO. : Des. 484,163 S
DATED : December 23, 2003
INVENTOR(S) : Young Hoon Kim

Page 1 of 3

It is certified that error appears in the above-identified patent and that said Letters Patent is hereby corrected as shown below:

Drawings,
Substitute the printed drawings with the attached replacement drawings.

Signed and Sealed this

Seventeenth Day of August, 2004

A handwritten signature in black ink that reads "Jon W. Dudas". The signature is written in a cursive style with a large, looped initial "J".

JON W. DUDAS
Acting Director of the United States Patent and Trademark Office

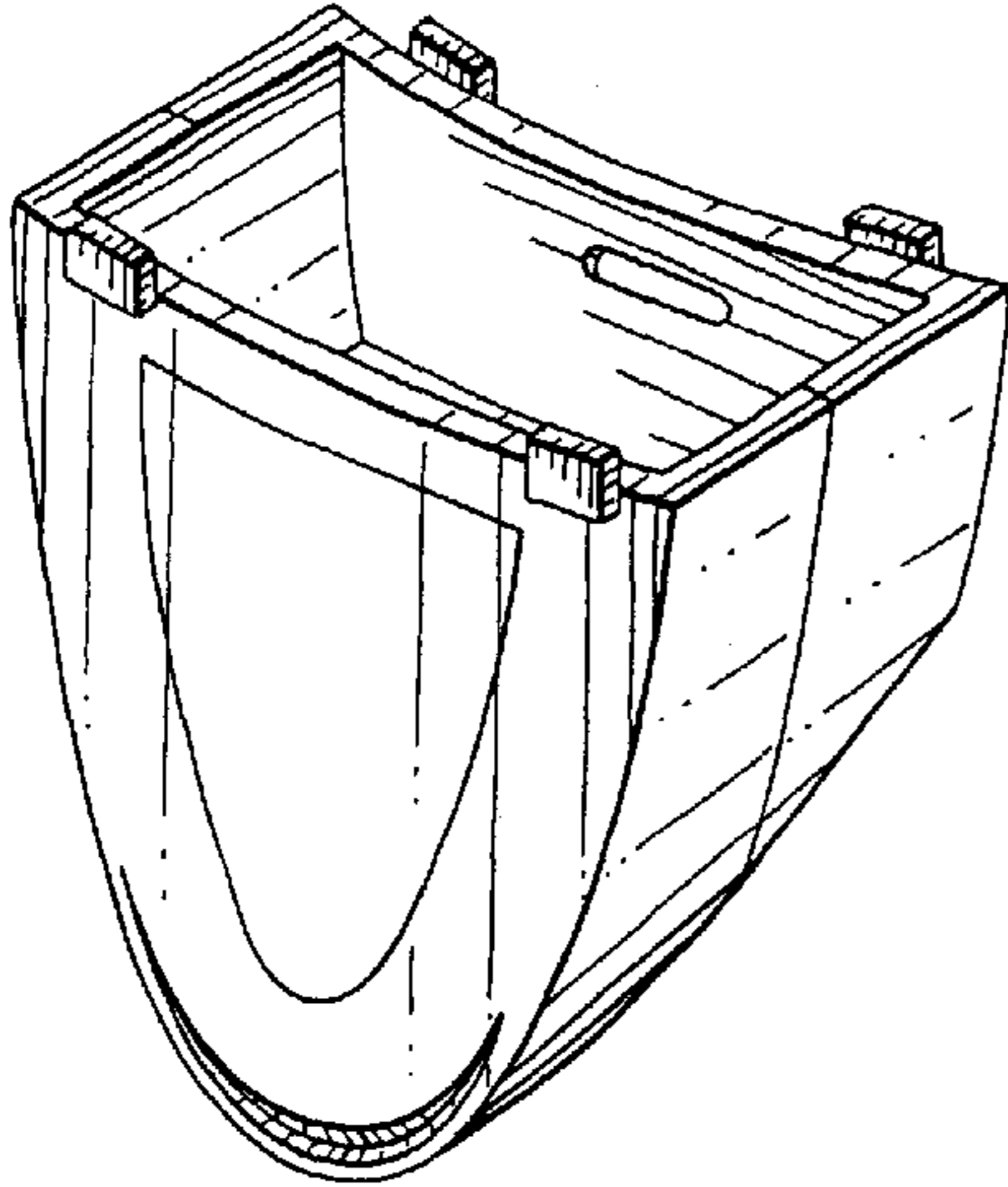

FIG. 1

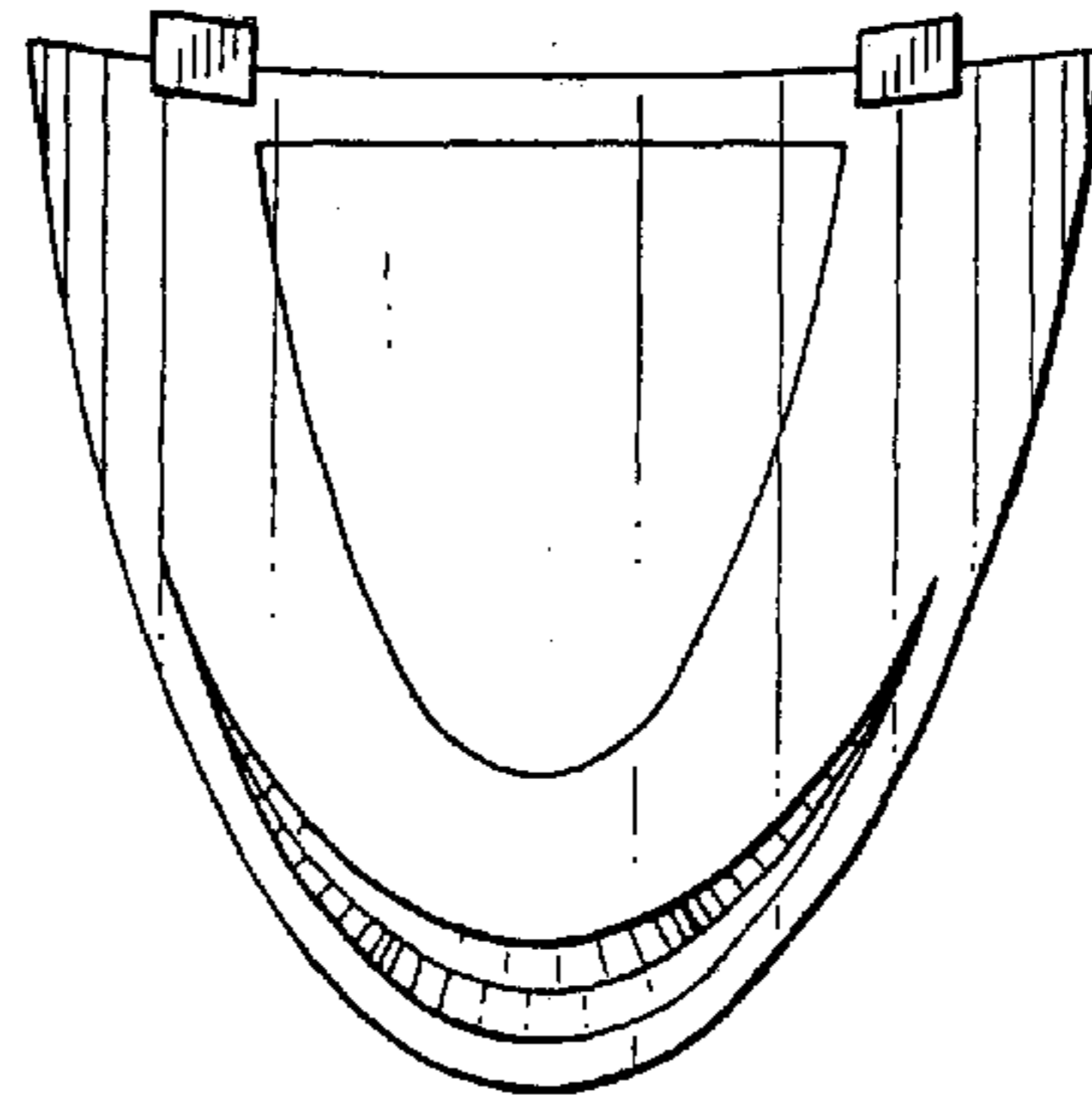

FIG. 2

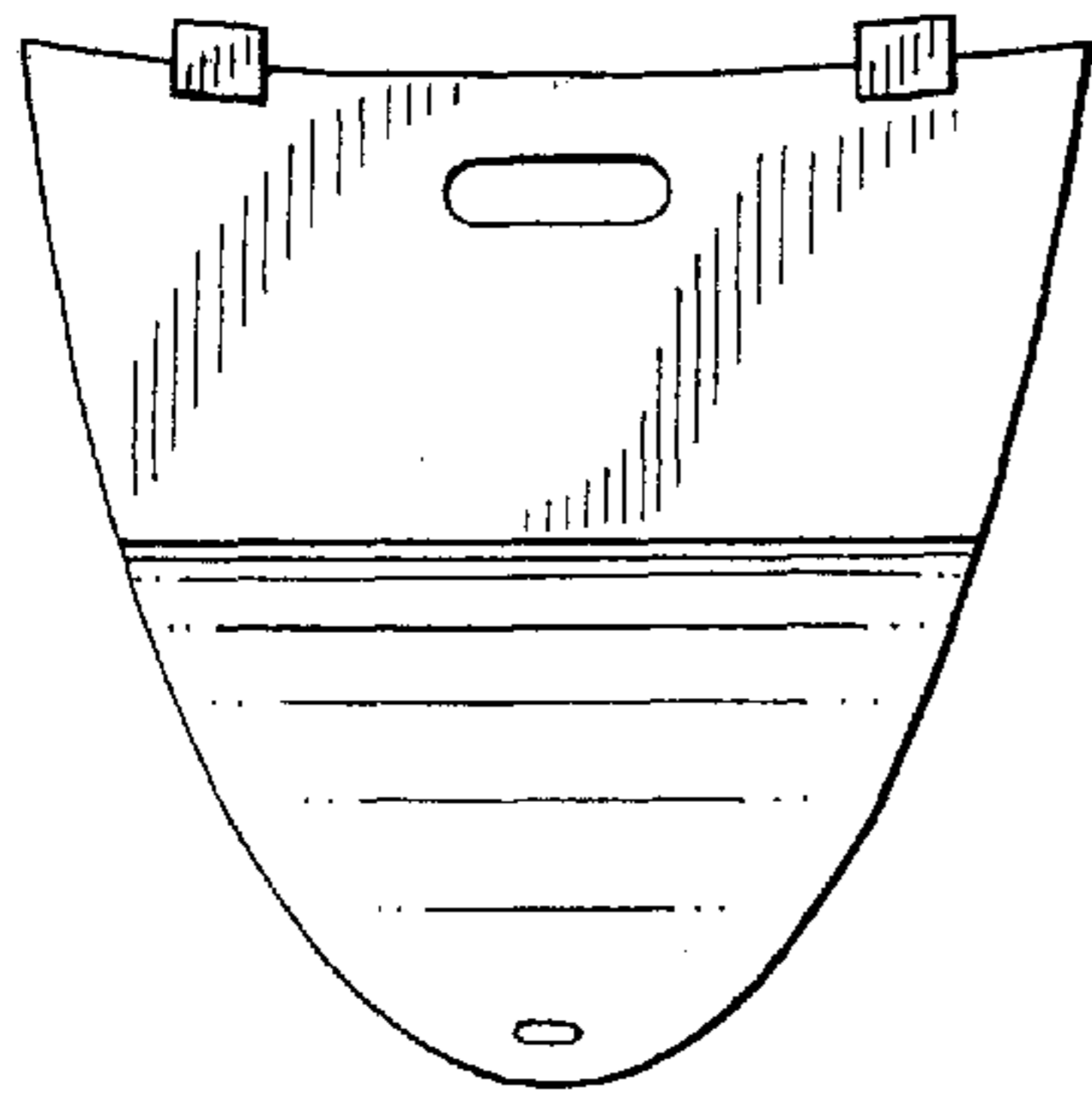

FIG. 3

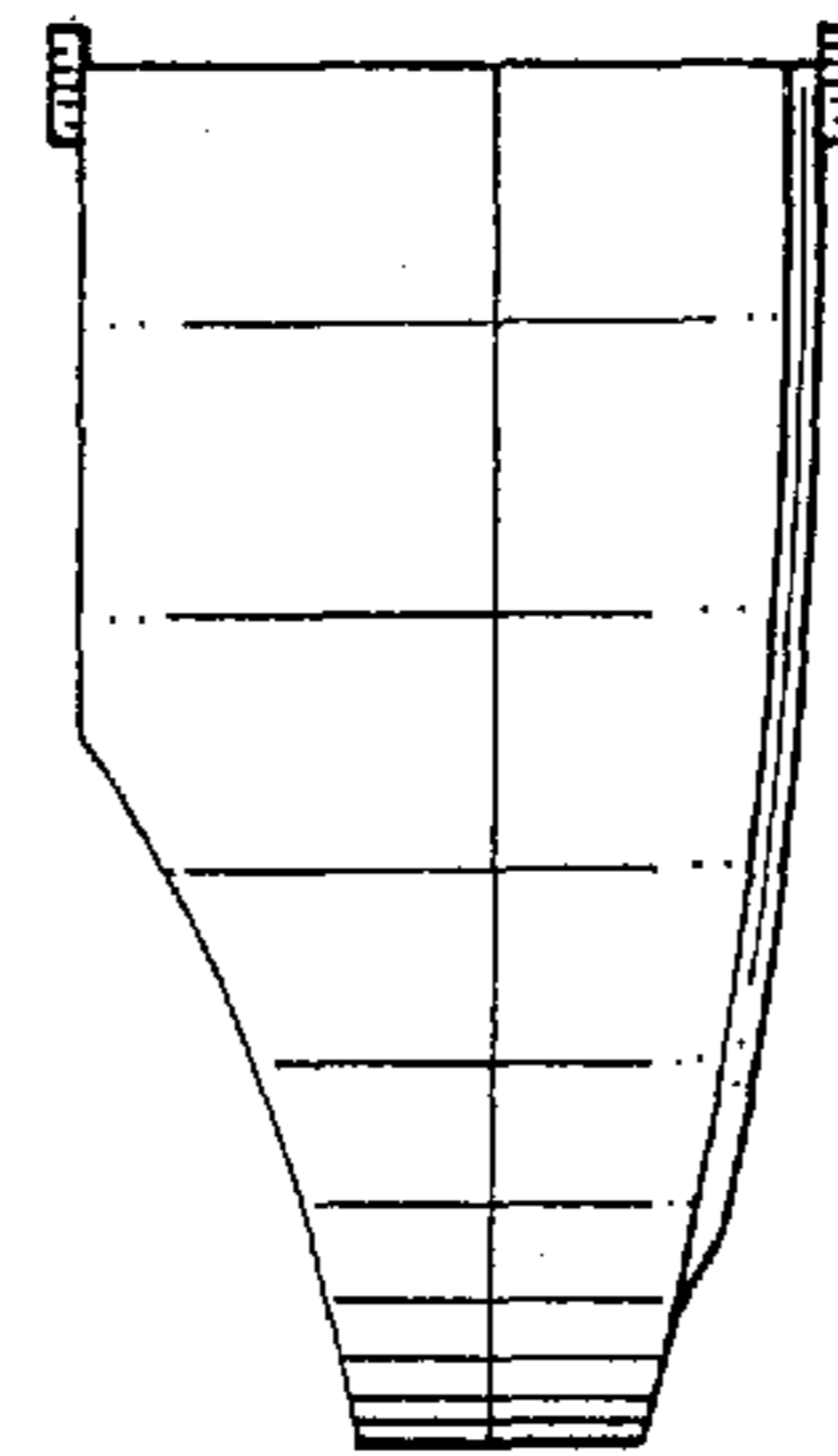

FIG. 4



FIG. 5

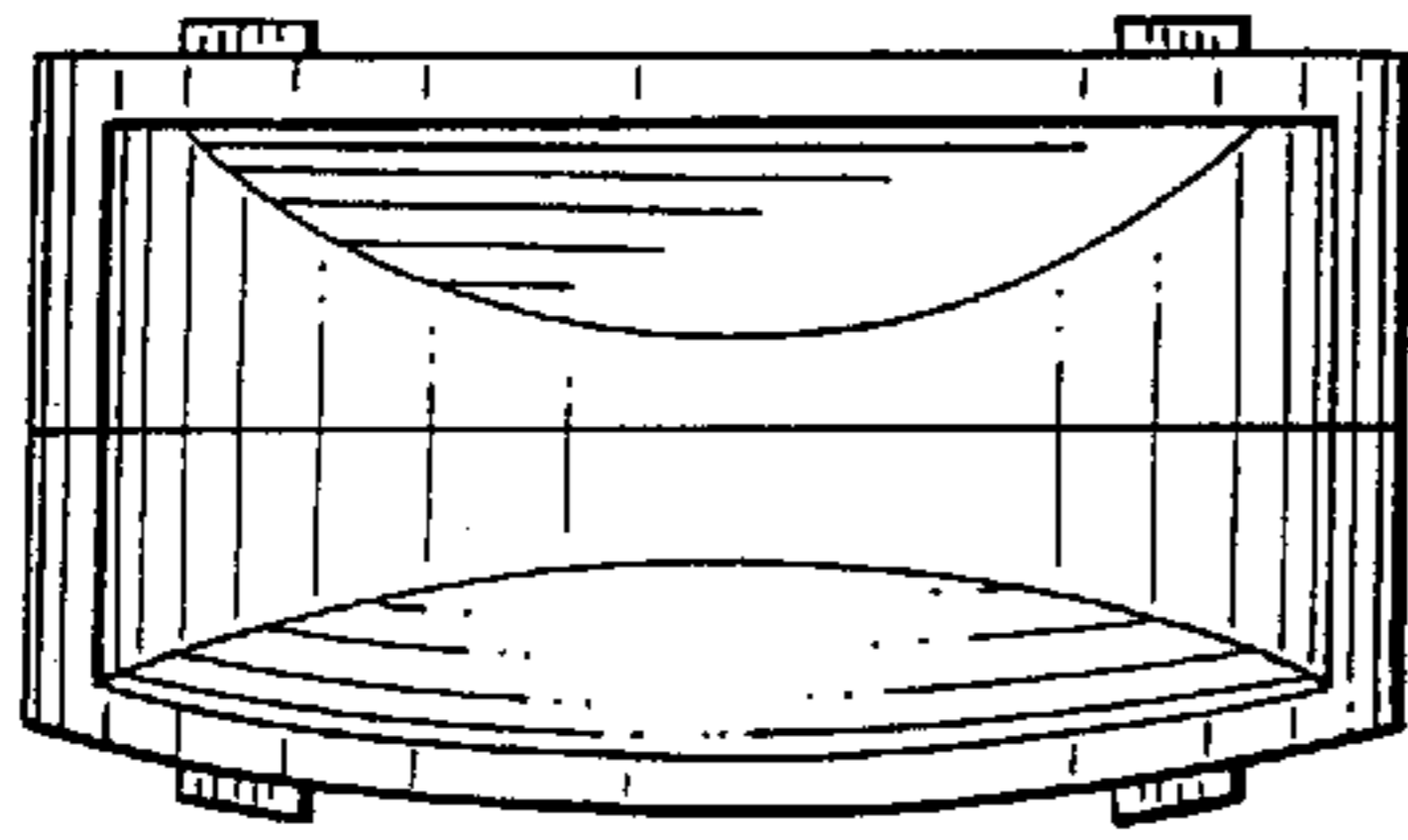

FIG. 6

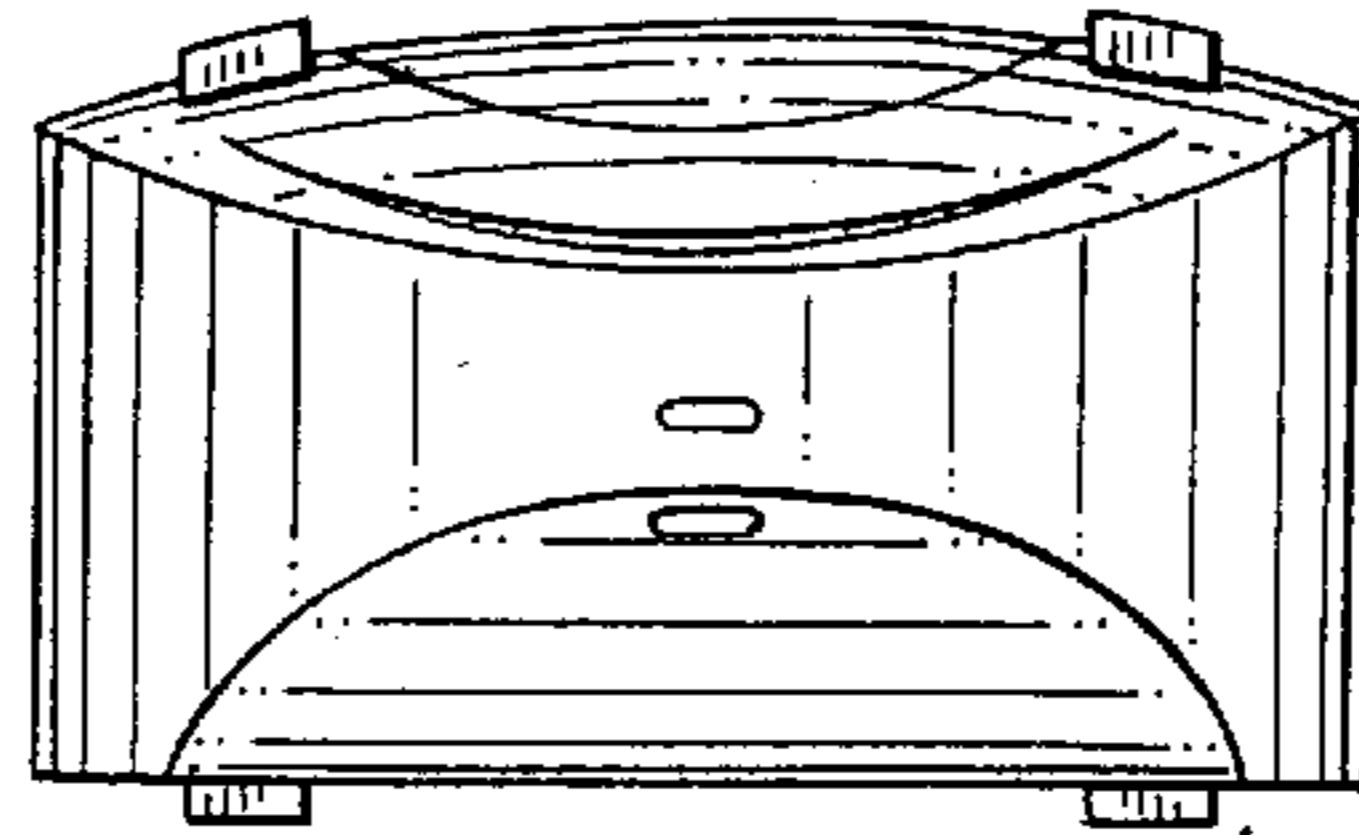

FIG. 7

