



US00D484138S

(12) **United States Design Patent**
Burmeister

(10) **Patent No.:** **US D484,138 S**

(45) **Date of Patent:** **** Dec. 23, 2003**

(54) **FRONT PANEL COMPRISING A CARD-SLOT**

D347,834 S * 6/1994 Garmon et al. D14/446

D362,248 S * 9/1995 Marotti et al. D14/442

(75) Inventor: **Kay Burmeister**, Altenberg (DE)

D409,988 S * 5/1999 Otis et al. D14/441

D431,824 S * 10/2000 Nagele et al. D14/443

(73) Assignee: **National Rejectors, Inc. GmbH**,
Buxtehude (DE)

* cited by examiner

(**) Term: **14 Years**

Primary Examiner—Freda Nunn

(21) Appl. No.: **29/172,663**

(74) *Attorney, Agent, or Firm*—Vidas, Arrett & Steinkraus,
P.A.

(22) Filed: **Dec. 16, 2002**

Related U.S. Application Data

(63) Continuation-in-part of application No. 29/127,335, filed on
Aug. 3, 2000, now Pat. No. Des. 467,249.

(30) **Foreign Application Priority Data**

Feb. 3, 2000 (WO) DM051/ 043

(51) **LOC (7) Cl.** **14-02**

(52) **U.S. Cl.** **D14/444**

(58) **Field of Search** D14/441–446,
D14/383–385; D13/162, 184, 199, 164,
177; 312/223.2; 361/680–686; D20/1, 8,
43, 28; 194/350, 351, 353; 235/33, 441;
705/18, 35

(57) **CLAIM**

The ornamental design for the front panel comprising a
card-slot, as shown and described.

DESCRIPTION

FIG. 1 is a front view of a front panel comprising a card-slot
showing my new design;

FIG. 2 is a left side view thereof;

FIG. 3 is a right side view thereof;

FIG. 4 is a rear side view thereof;

FIG. 5 is a top side view thereof;

FIG. 6 is a bottom side view thereof; and,

FIG. 7 is a perspective view of the invention.

(56) **References Cited**

U.S. PATENT DOCUMENTS

D324,212 S * 2/1992 Garmon et al. D14/442

1 Claim, 3 Drawing Sheets

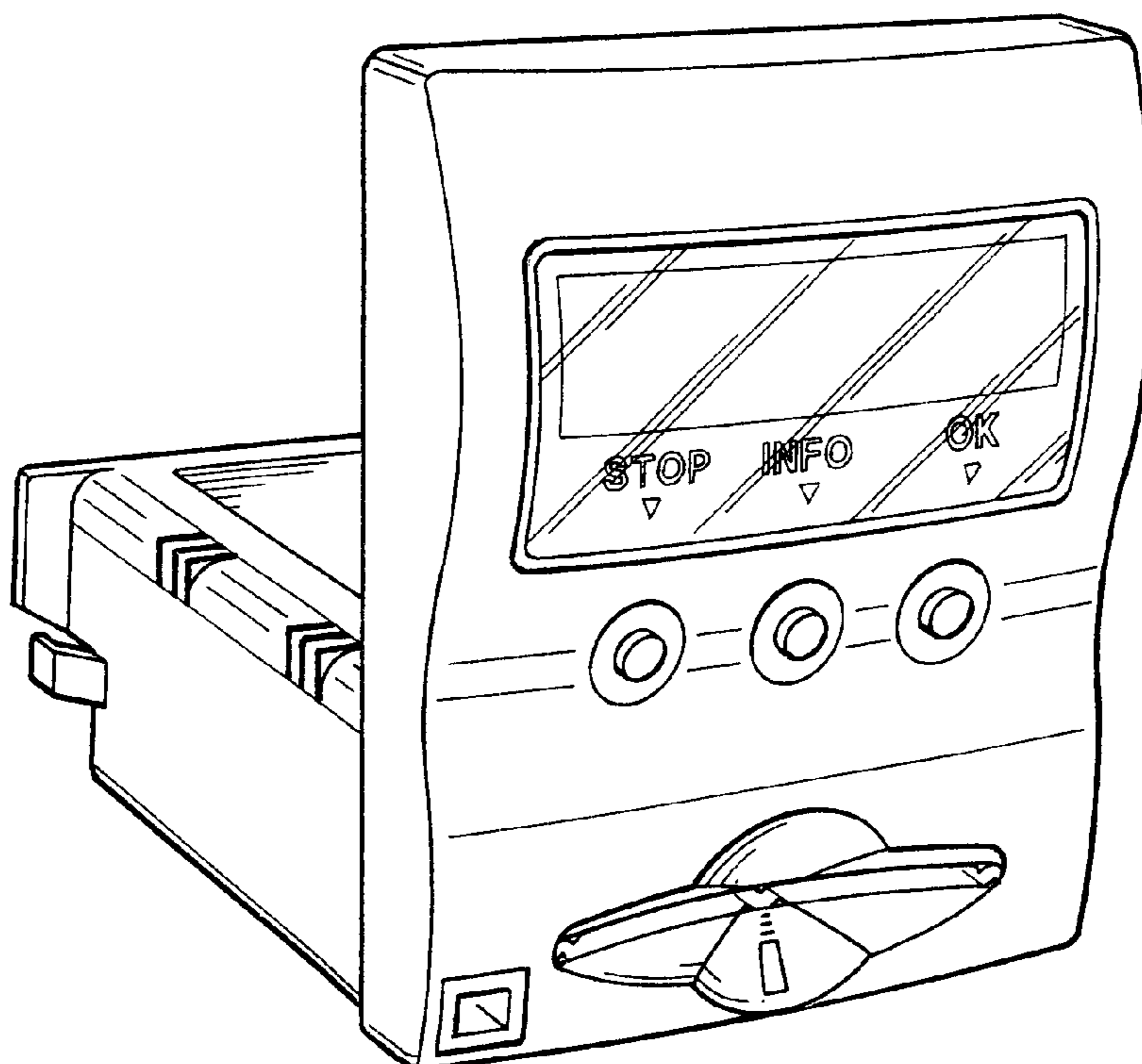

FIG. 2

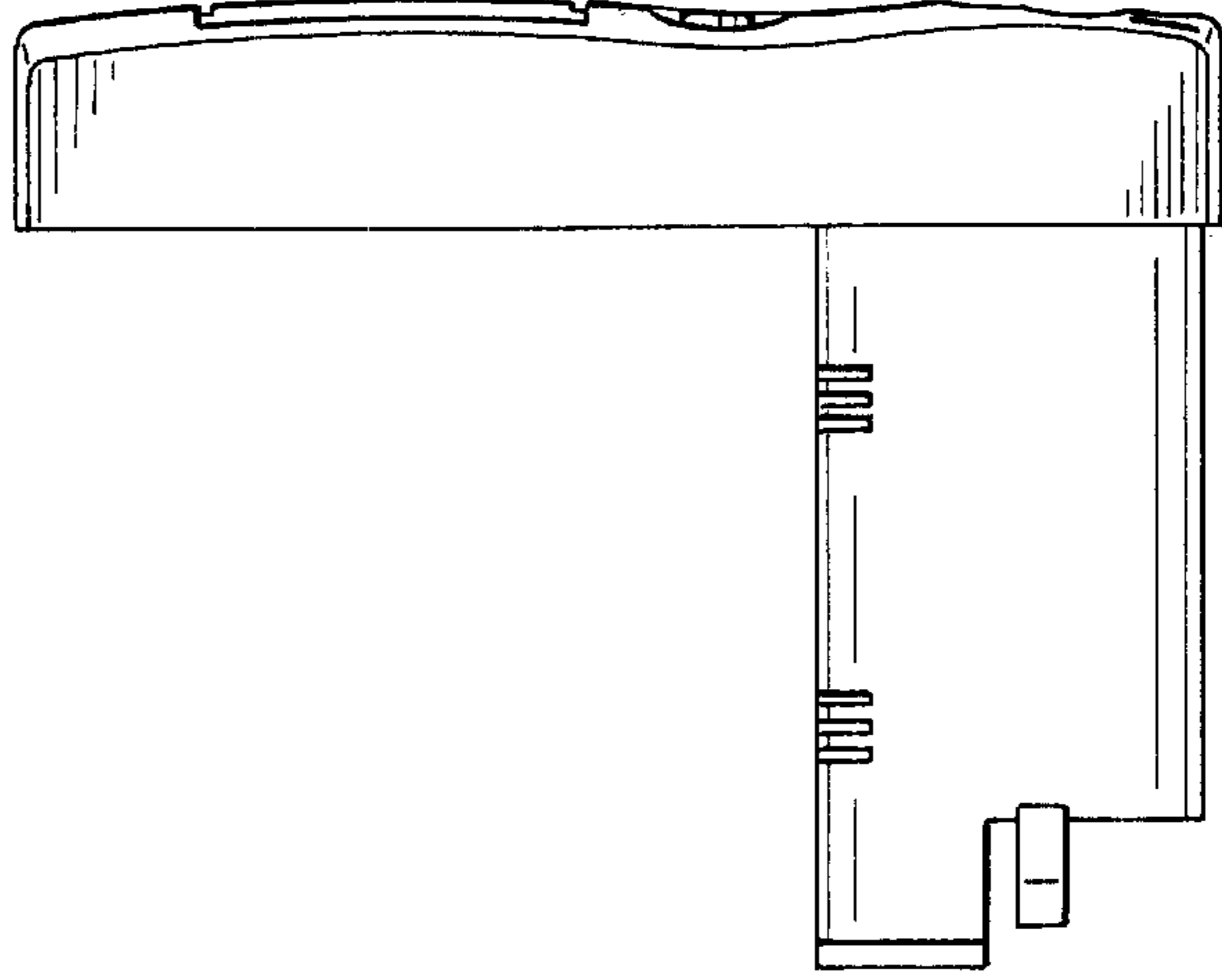

FIG. 1

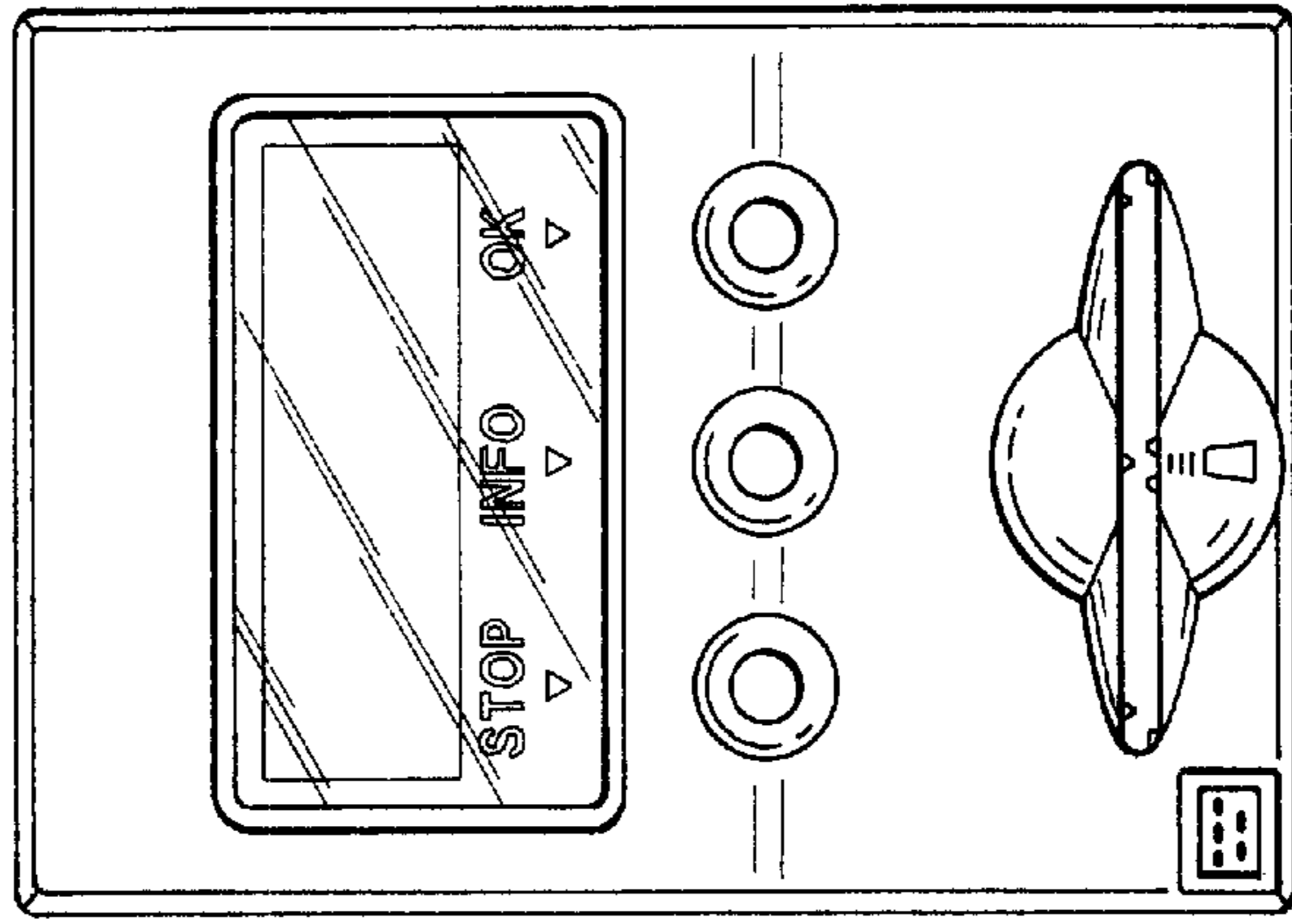

FIG. 3

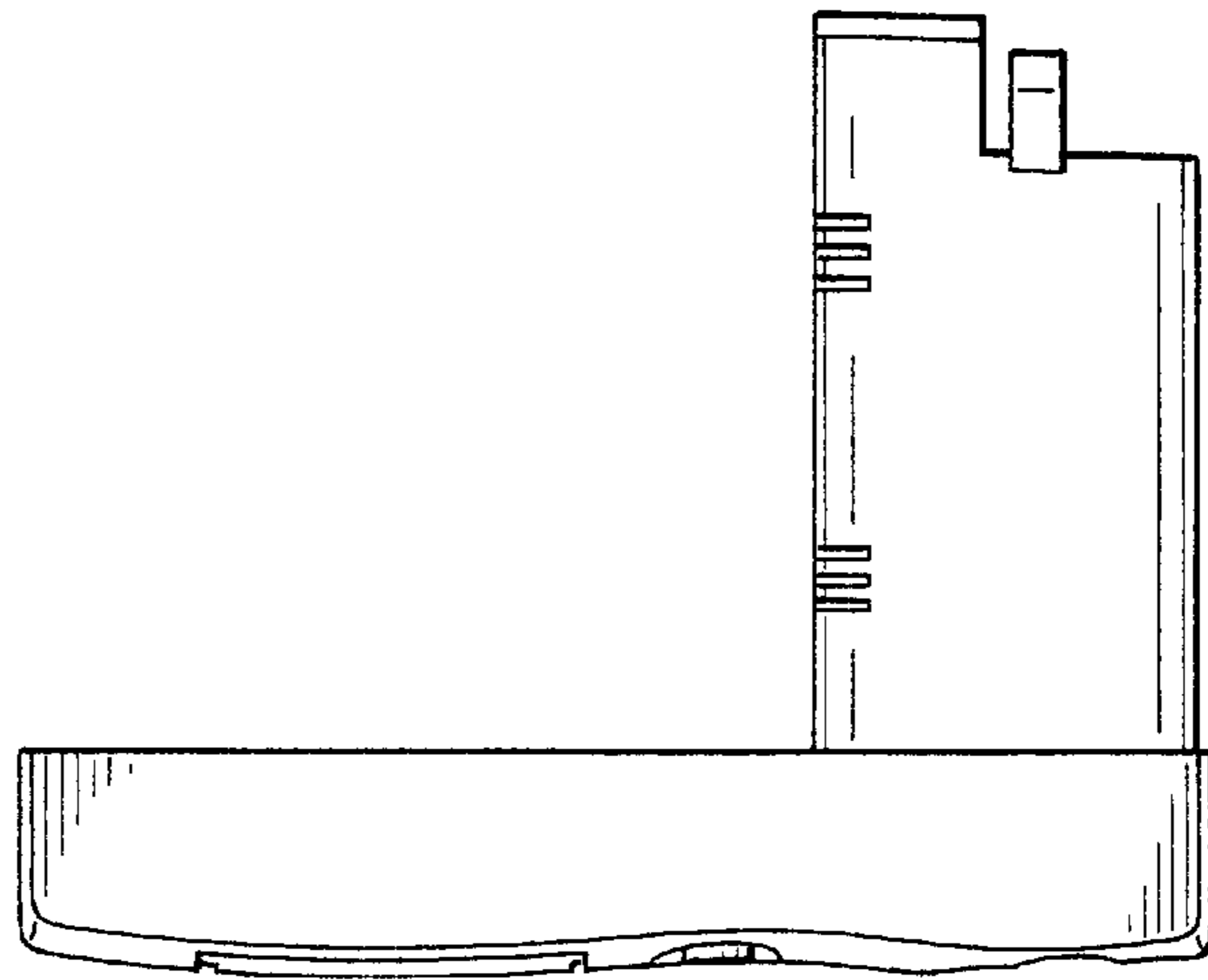

FIG. 5

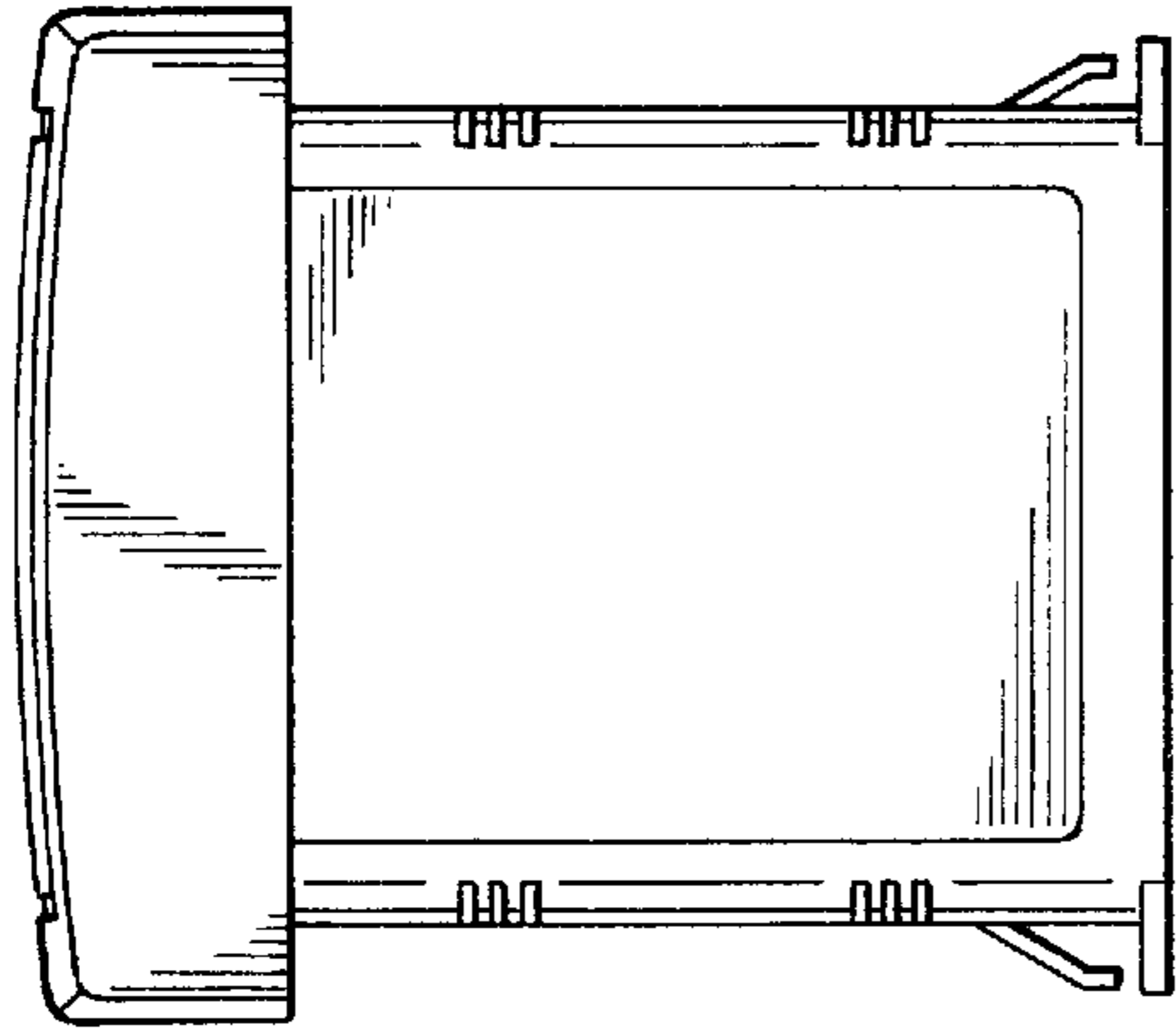

FIG. 6

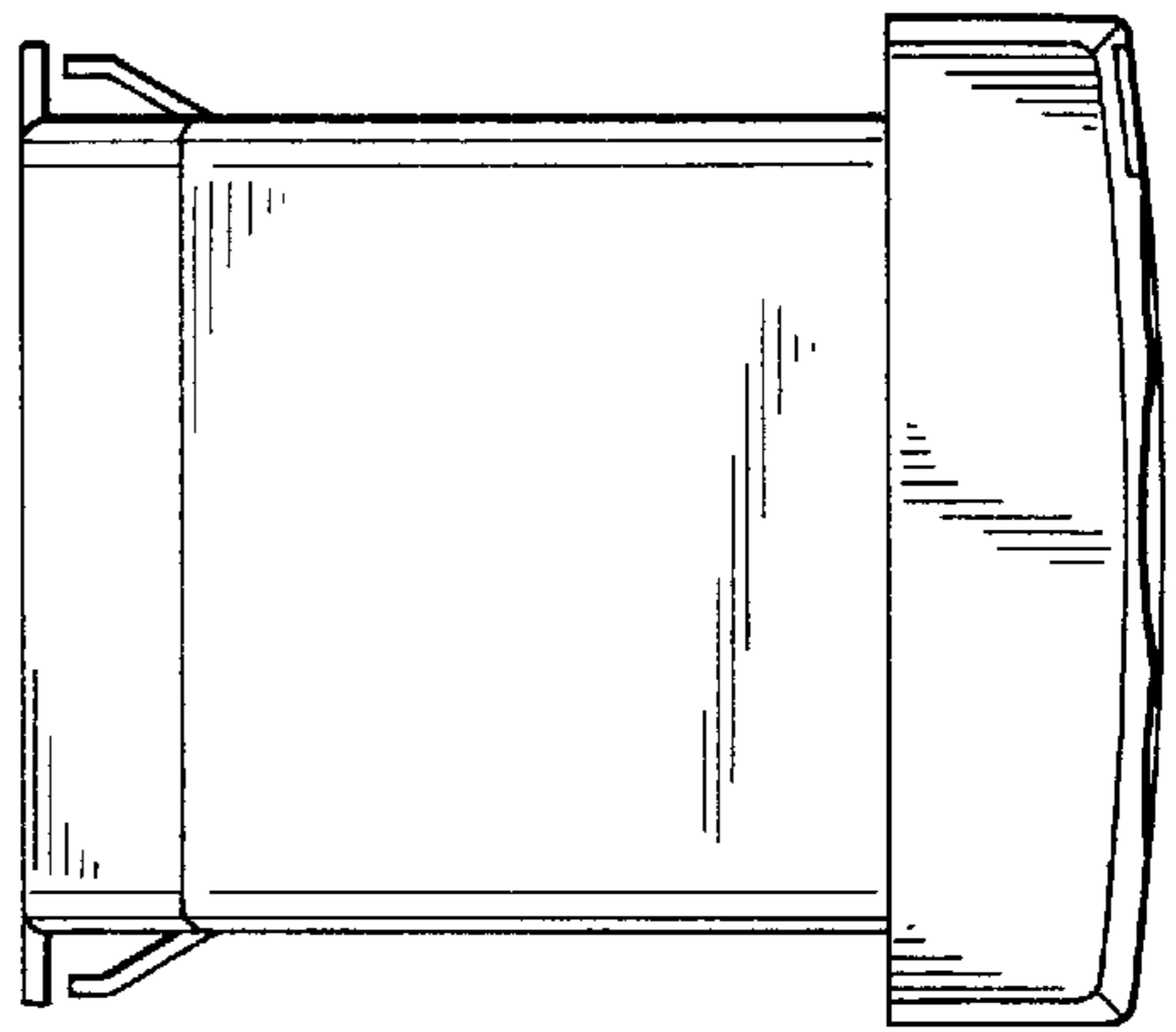

FIG. 4

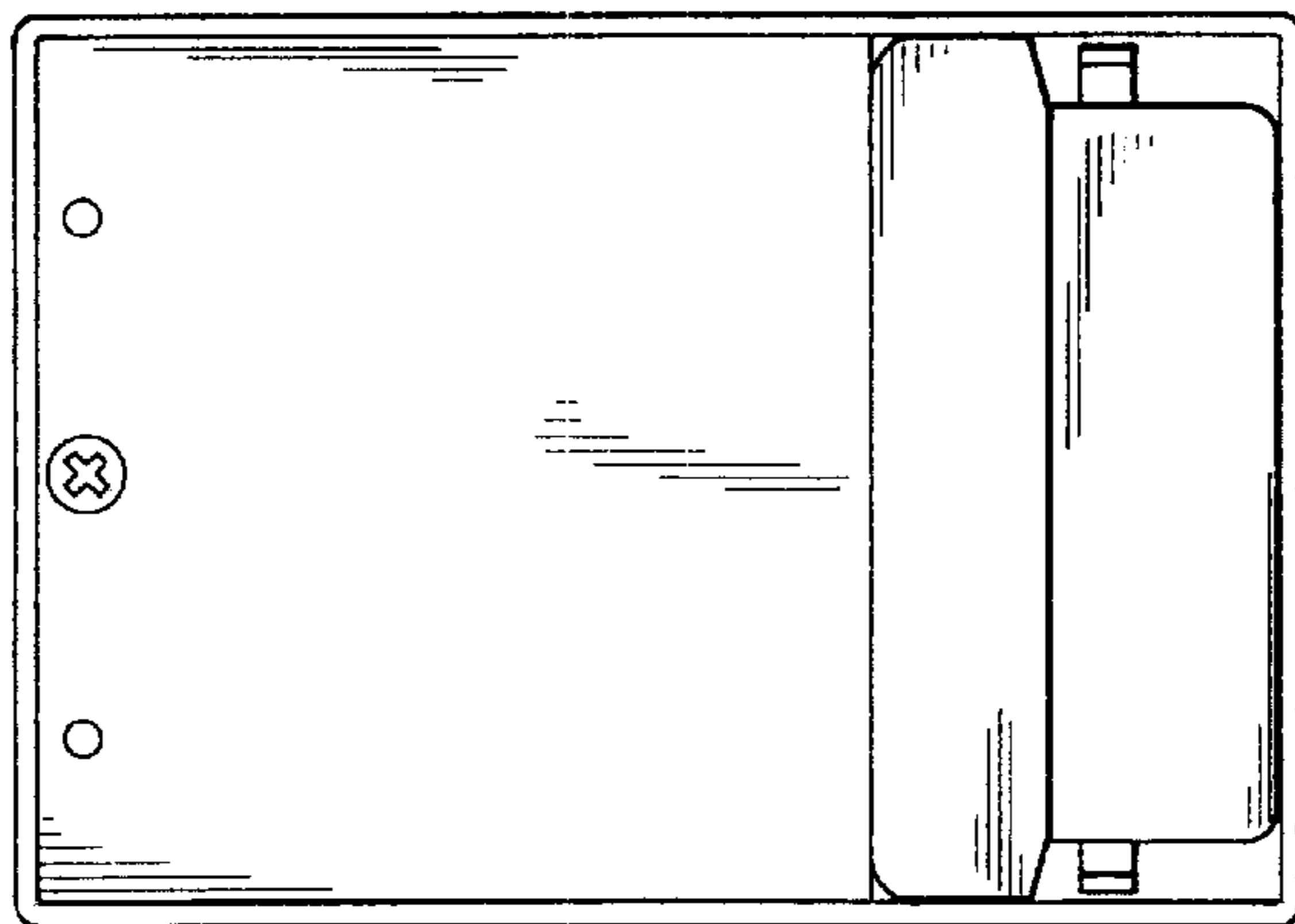

FIG. 7

