



US00D483993S

(12) **United States Design Patent**
Boyle et al.

(10) **Patent No.:** **US D483,993 S**

(45) **Date of Patent:** **** Dec. 23, 2003**

(54) **BLENDER JAR DESIGN**

(75) Inventors: **Kenneth C. Boyle**, Newton, IA (US);
Annette D. Bravard, Pleasant Hill, IA
(US); **John C. Thomas**, Newton, IA
(US); **Joshua D. Dickman**, Powell, OH
(US); **Brian K. Linstedt**, Ostrander,
OH (US)

(73) Assignee: **Maytag Corporation**, Newton, IA (US)

(**) Term: **14 Years**

(21) Appl. No.: **29/183,074**

(22) Filed: **Jun. 5, 2003**

(51) **LOC (7) Cl.** **31-00**

(52) **U.S. Cl.** **D7/413; D7/316**

(58) **Field of Search** D7/376-386, 312-322,
D7/412, 413; 241/30, 33, 37.5, 101.01-101.2,
274, 275; 366/64-67, 197-207, 241-254,
341

(56) **References Cited**

U.S. PATENT DOCUMENTS

D373,504 S * 9/1996 Leverrier D7/378
5,567,049 A 10/1996 Beaudet et al.
5,636,923 A 6/1997 Nejat-Bina
D400,757 S * 11/1998 Hippen et al. D7/378
D412,809 S * 8/1999 Toro et al. D7/378
D439,797 S * 4/2001 Planca et al. D7/378
D448,967 S * 10/2001 Planca et al. D7/378

D453,279 S * 2/2002 Huang D7/318
6,402,365 B1 6/2002 Wong
D465,127 S * 11/2002 Lee D7/378
2002/0176320 A1 11/2002 Wulf et al.

FOREIGN PATENT DOCUMENTS

GB 2073937 * 4/1998

* cited by examiner

Primary Examiner—Caron D. Veynar

(74) *Attorney, Agent, or Firm*—McKee, Voorhees & Sease,
P.L.C.

(57) **CLAIM**

The ornamental design for a blender jar design, substantially
as shown.

DESCRIPTION

FIG. 1 is a perspective view of the blender jar design of the
present application.

FIG. 2 is a front elevation view of the blender jar.

FIG. 3 is a rear elevation view of the jar.

FIG. 4 is a side elevation view of the jar.

FIG. 5 is a side elevation view of the jar from the opposite
side as shown in FIG. 4.

FIG. 6 is a top plan view of the jar; and,

FIG. 7 is a bottom plan view of the jar.

The features shown in broken lines form no part of the
claimed invention.

1 Claim, 6 Drawing Sheets

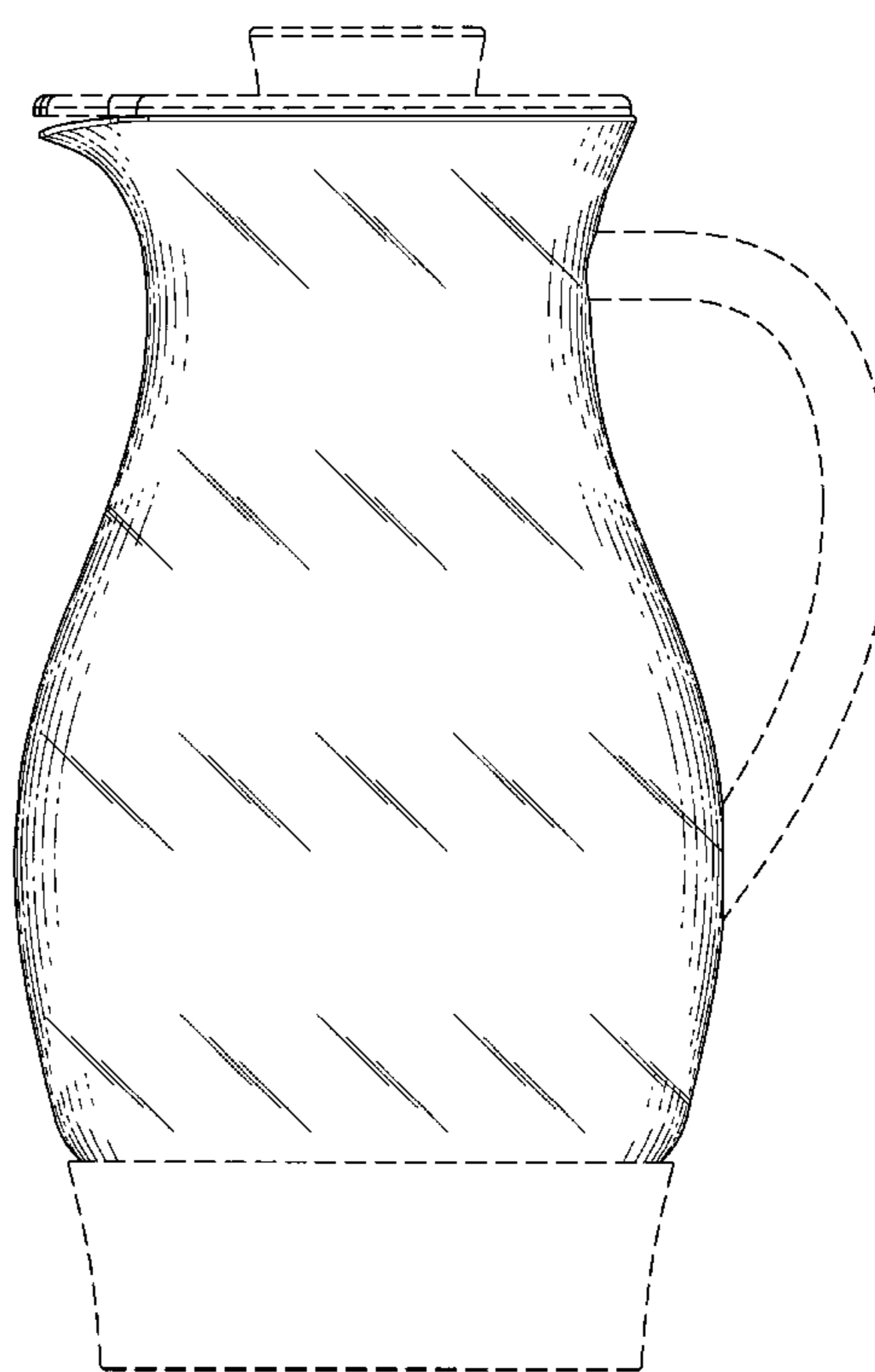
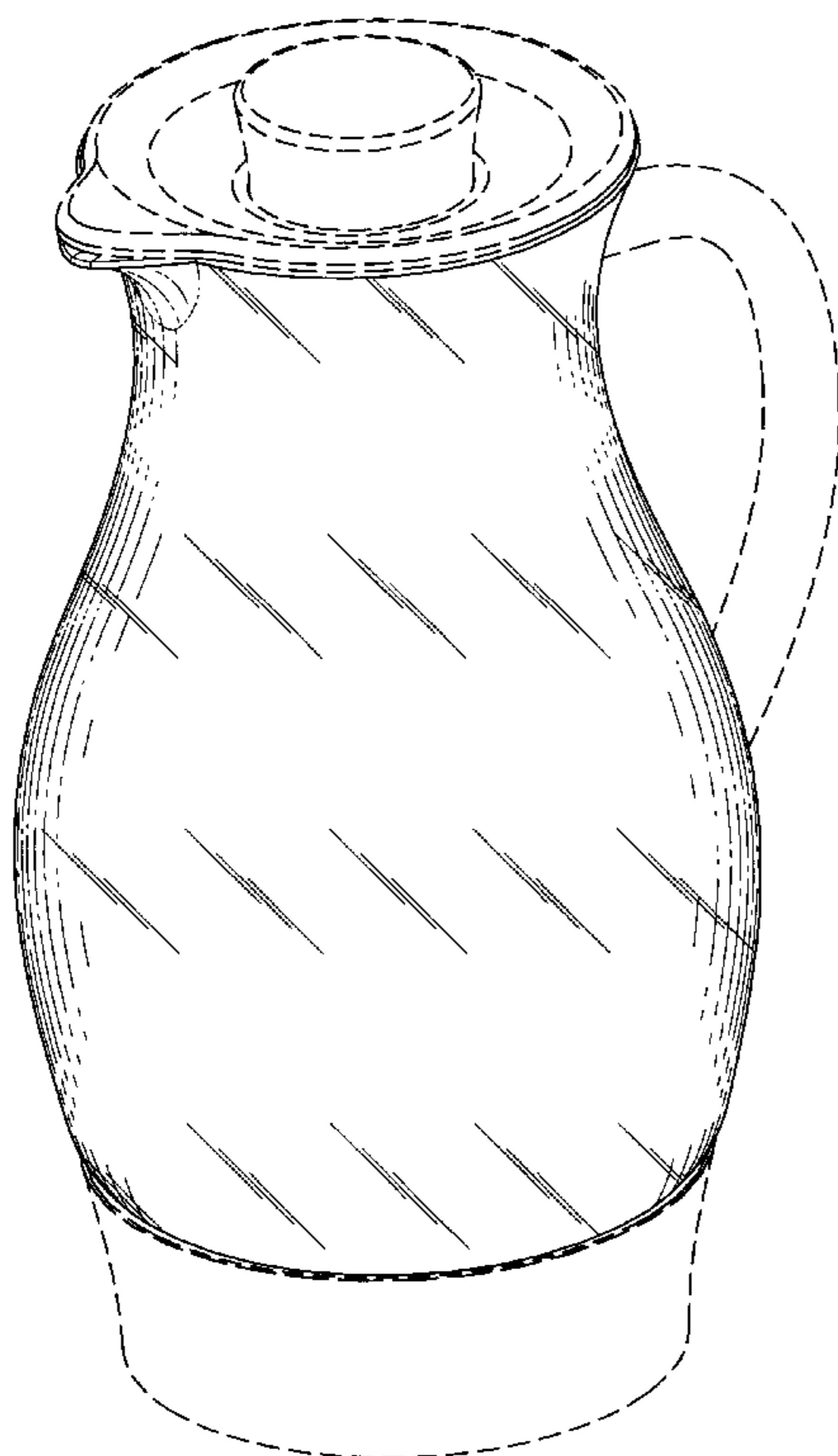

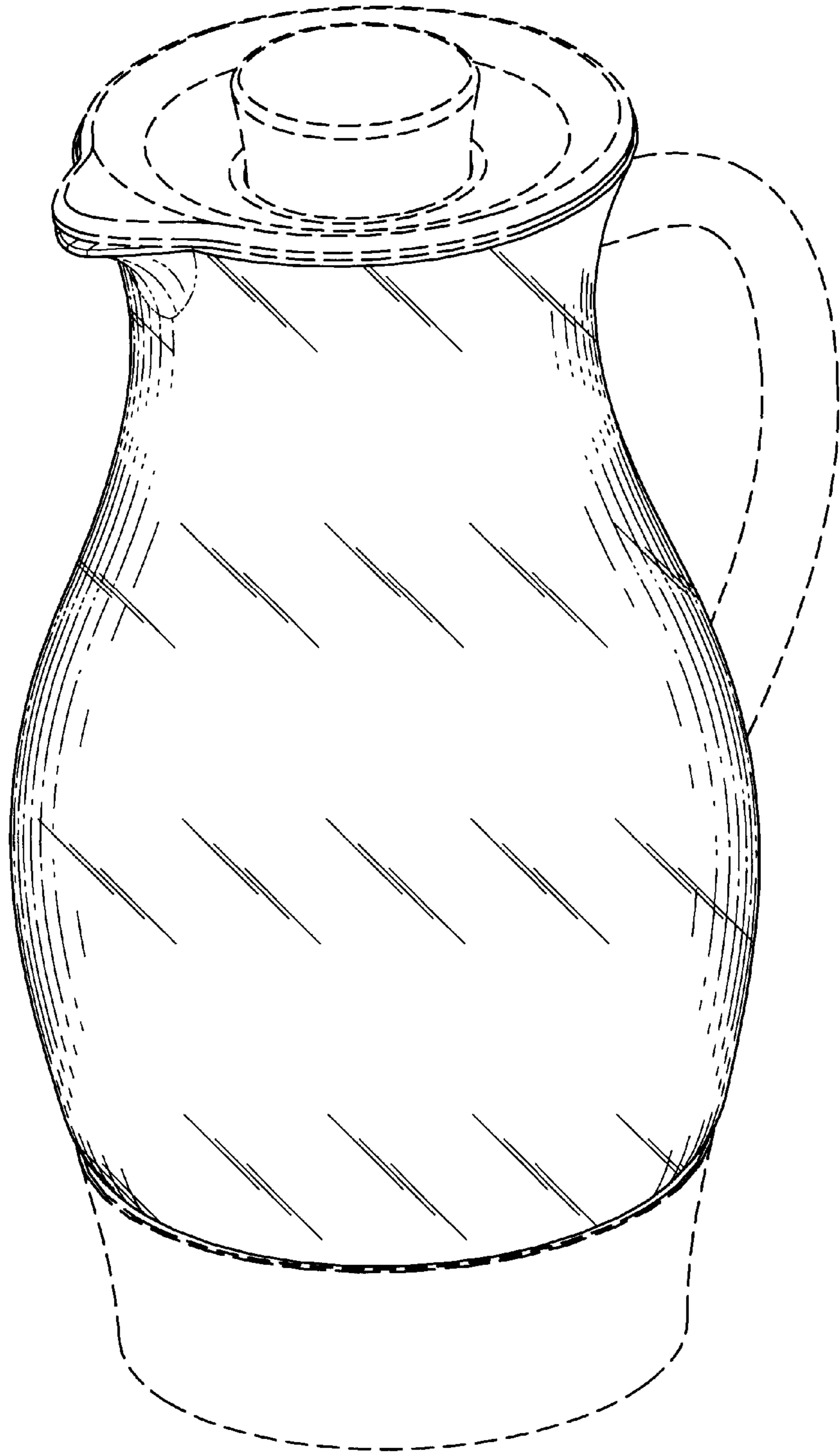

Fig. 1

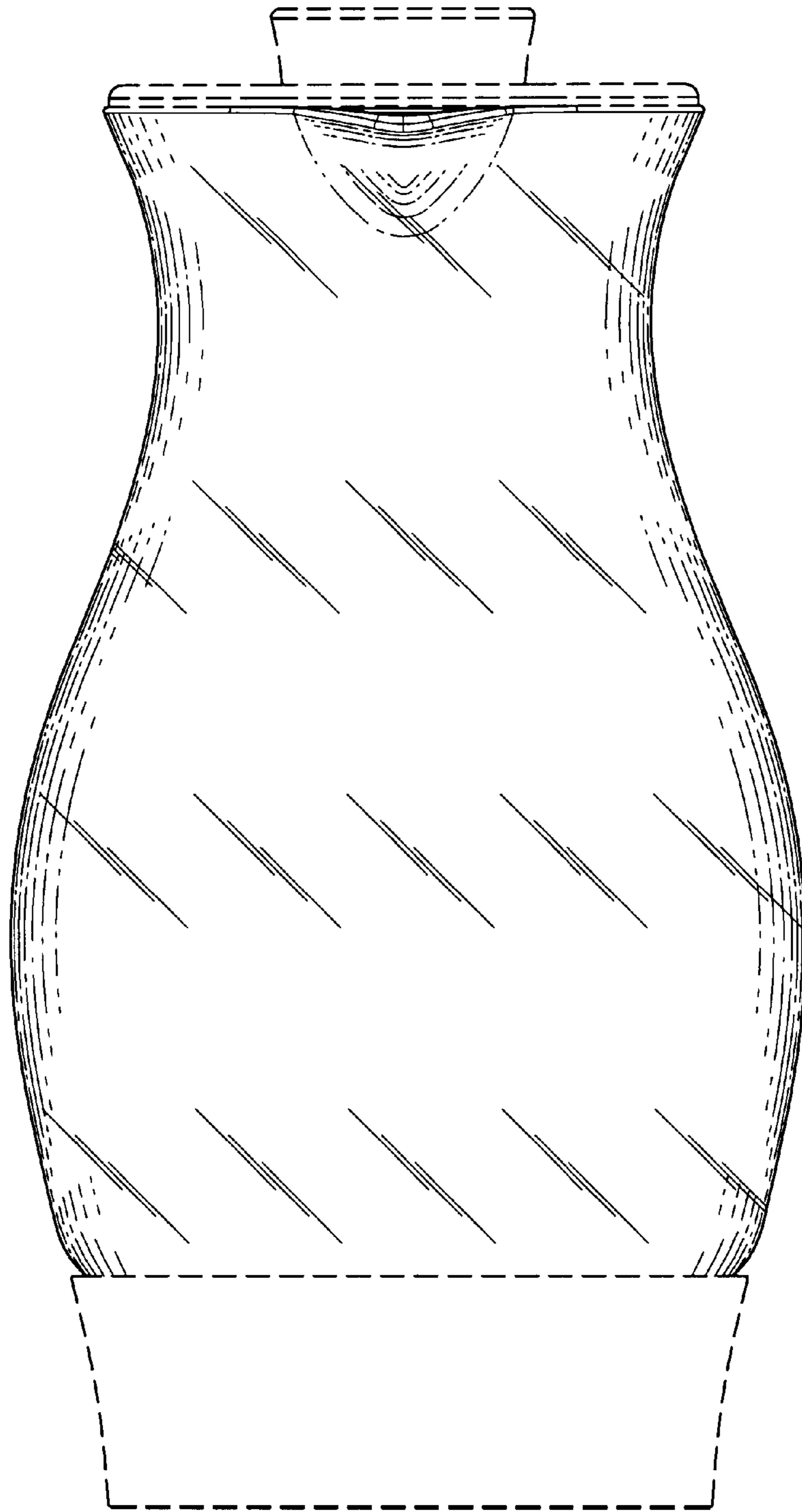

Fig. 2

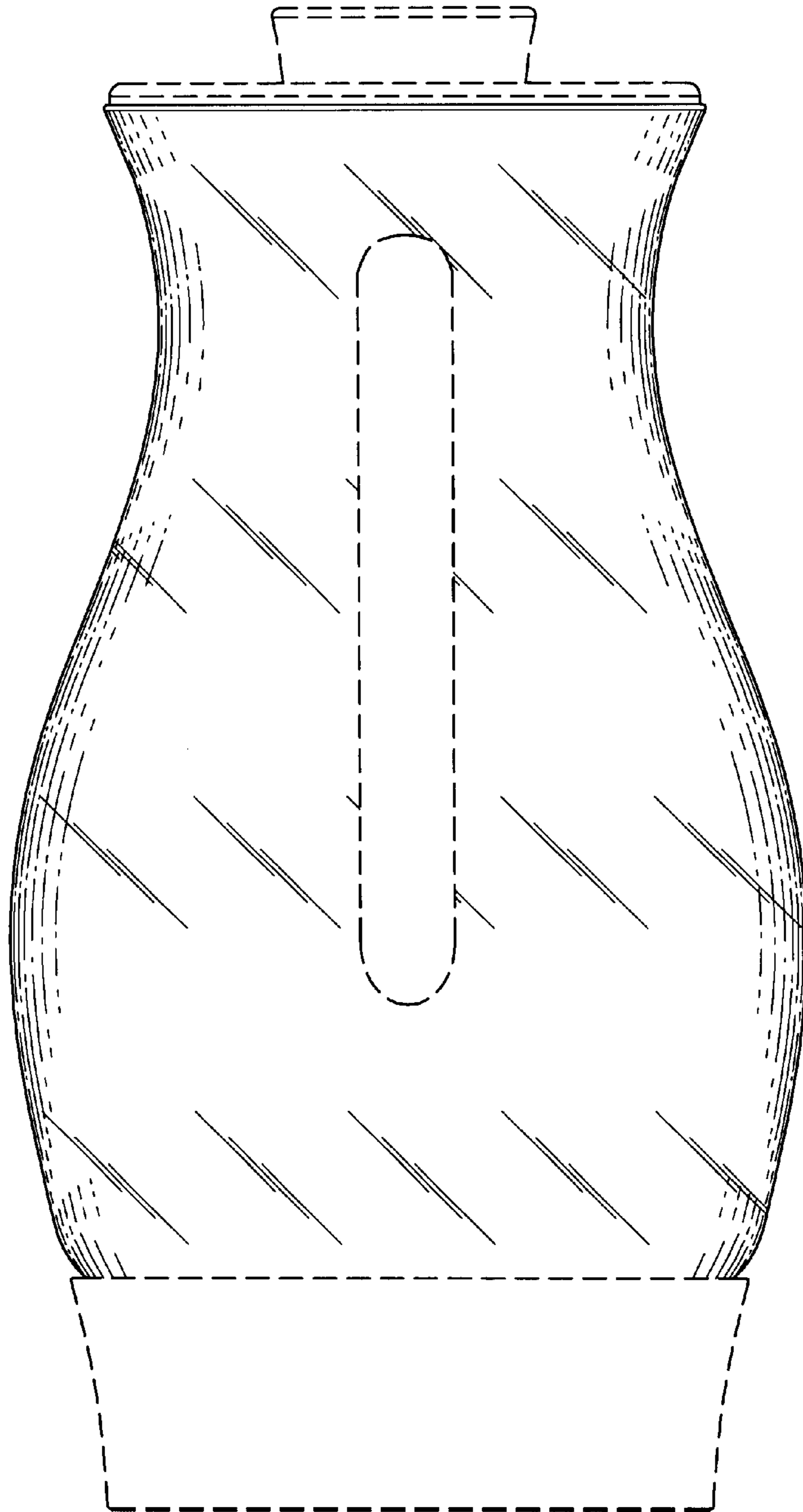

Fig. 3

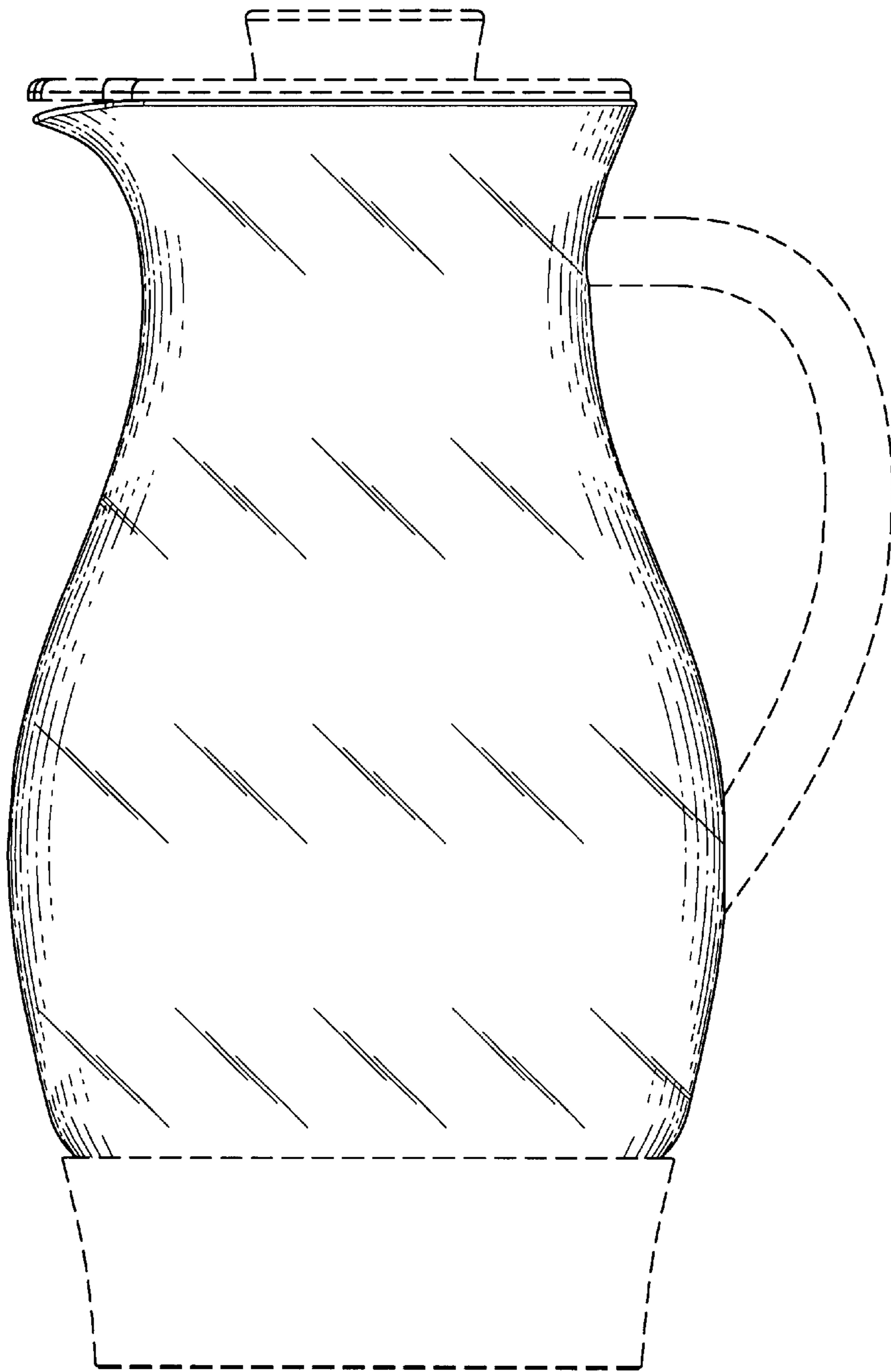

Fig. 4

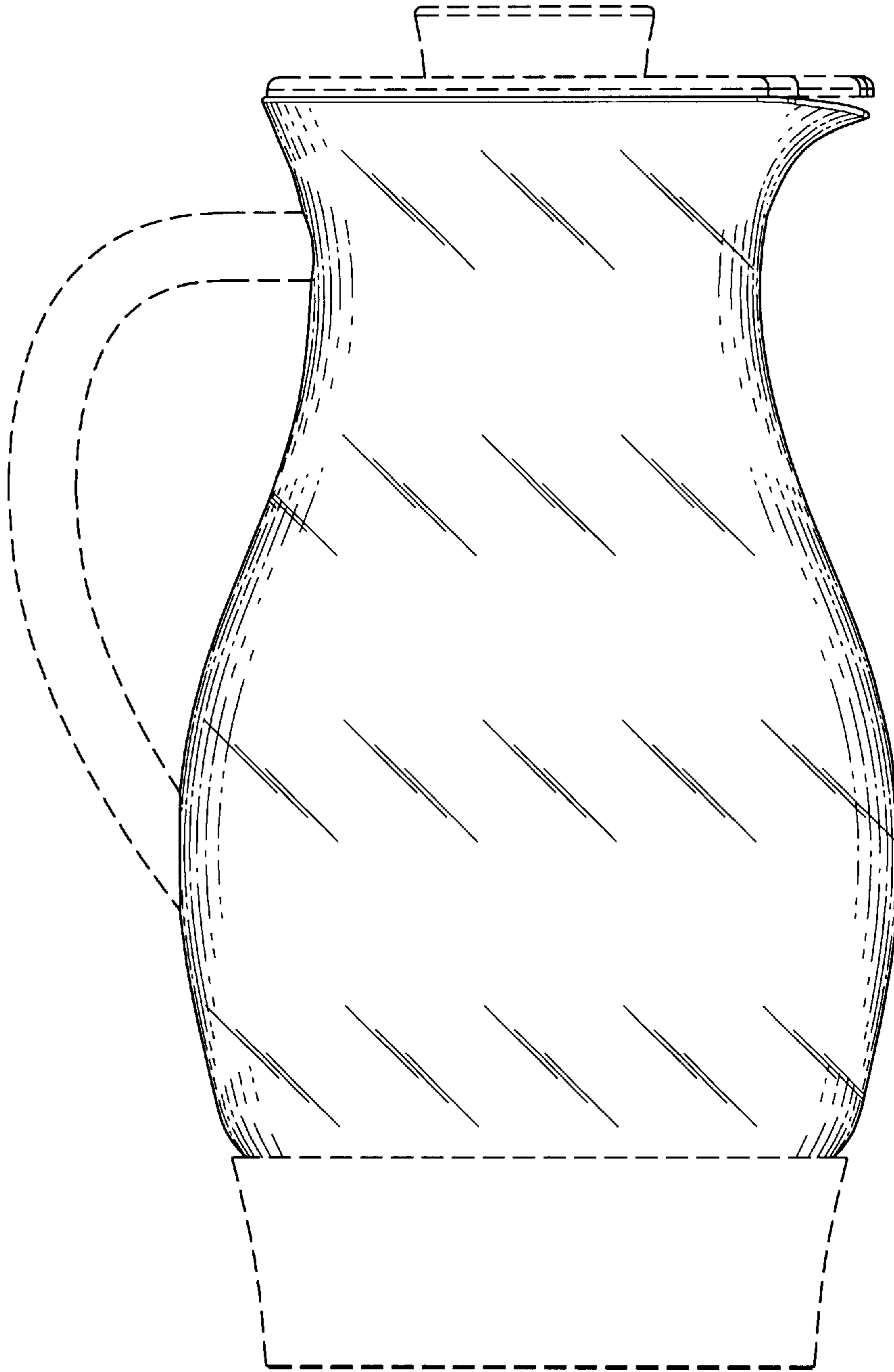

Fig. 5

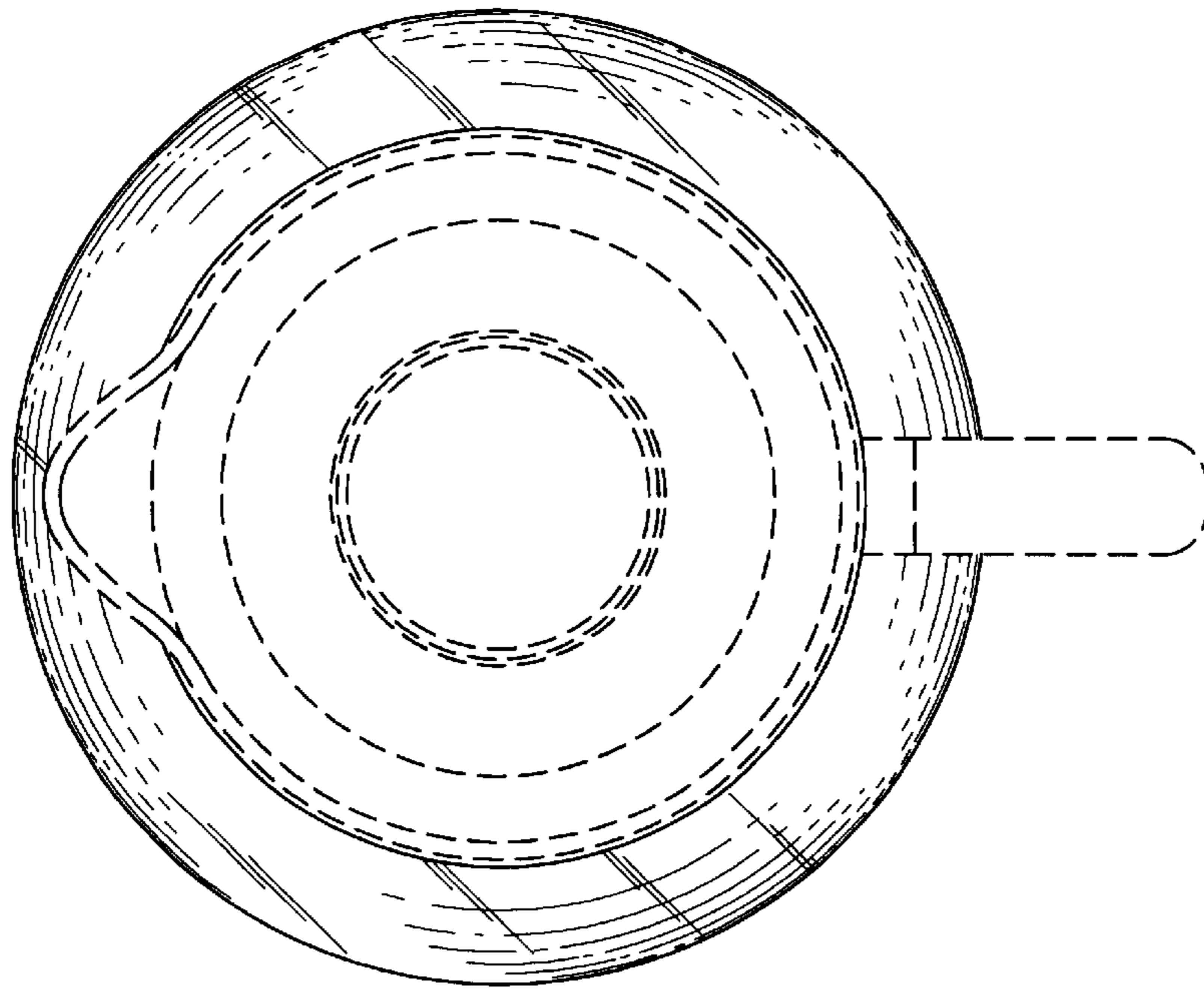

Fig. 6

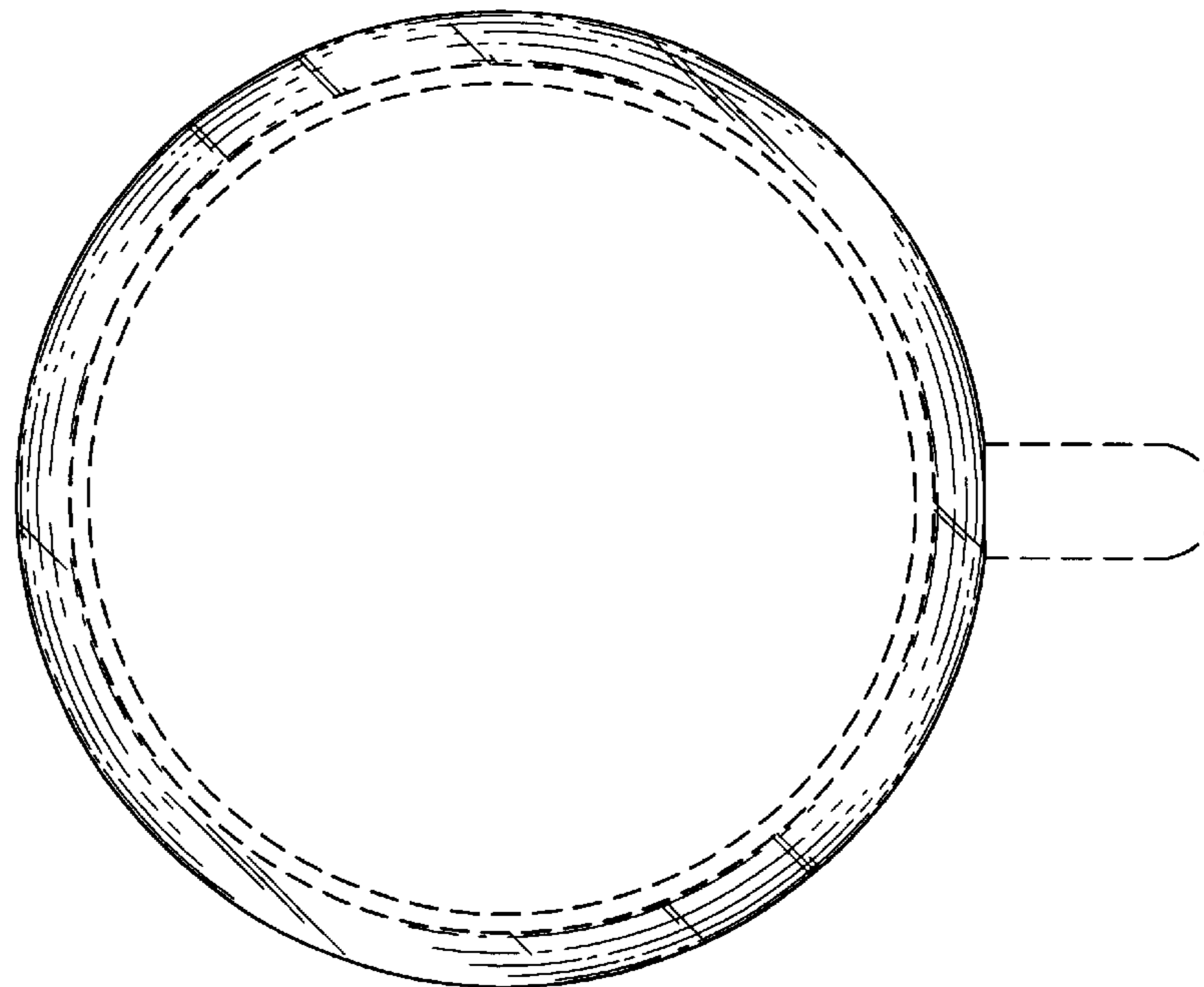

Fig. 7