



US00D483951S

(12) **United States Design Patent**  
**Little**

(10) **Patent No.:** **US D483,951 S**

(45) **Date of Patent:** **\*\* Dec. 23, 2003**

(54) **HAIR BRUSH WITH BRISTLE CLUSTERS**

(76) Inventor: **Kellie J. Little**, 57 B Rodgers St., San Francisco, CA (US) 94103

(\*\*) Term: **14 Years**

(21) Appl. No.: **29/175,921**

(22) Filed: **Feb. 13, 2003**

(51) **LOC (7) Cl.** ..... **04-02**

(52) **U.S. Cl.** ..... **D4/133**

(58) **Field of Search** ..... D4/133, 134, 136, D4/138; 15/143.1, 159.1, 160, 186-188, 207.2, DIG. 5; 132/120, 212, 271, 313

(56) **References Cited**

**U.S. PATENT DOCUMENTS**

3,128,487	A	*	4/1964	Vallis	.....	15/160	X
3,727,260	A	*	4/1973	Spydevold	.....	15/207.2	
4,014,064	A	*	3/1977	Okazaki	.....	15/207.2	
D307,217	S	*	4/1990	Fong	.....	D4/134	

\* cited by examiner

*Primary Examiner*—Alan P. Douglas

*Assistant Examiner*—Lavone D. Tabor

(74) *Attorney, Agent, or Firm*—Rick Martin; Patent Law Offices of Rick Martin, P.C.

(57) **CLAIM**

The ornamental design for a hair brush with bristle clusters, as shown.

**DESCRIPTION**

FIG. 1 is a top perspective view of a hair brush with bristle clusters;

FIG. 2 is a top plan view thereof;

FIG. 3 is a bottom plan view thereof;

FIG. 4 is a right side elevation view thereof;

FIG. 5 is a front elevation view thereof;

FIG. 6 is a rear elevation view thereof; and,

FIG. 7 is a close up view of the bristle clusters on the segment labeled 7 in FIG. 2.

The bristles are partially shown for ease of illustration in FIGS. 1-6, with the understanding that each of the somewhat uniformly spaced tufts, which for the most part, is represented by a single bristle, appears as shown in FIG. 7.

**1 Claim, 2 Drawing Sheets**

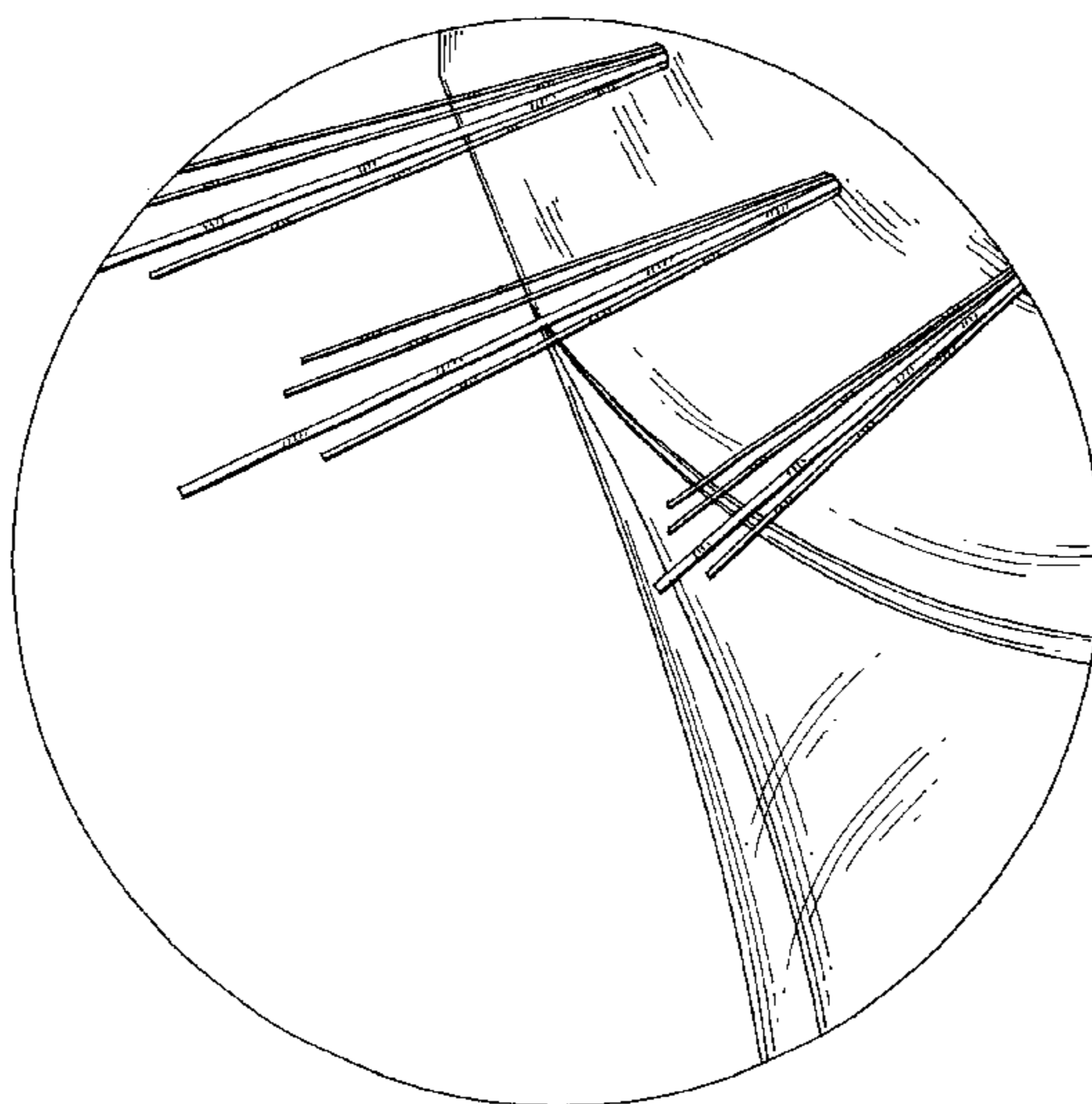
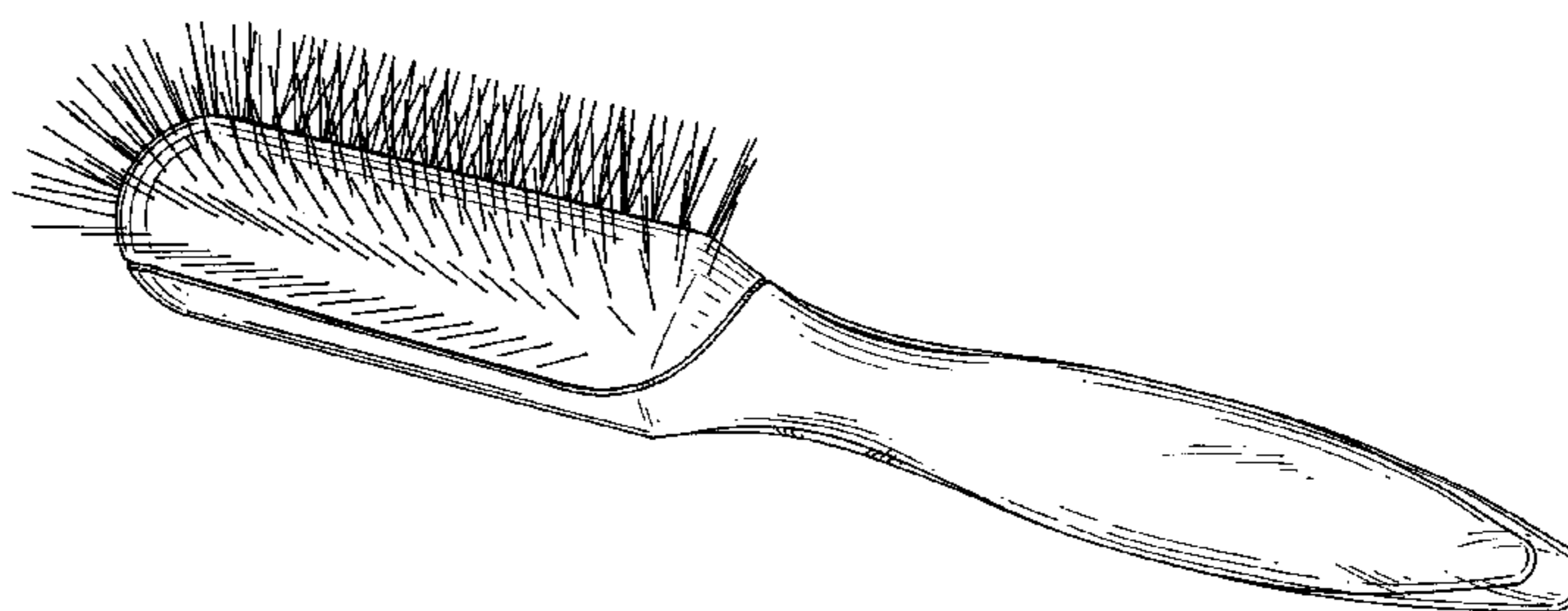

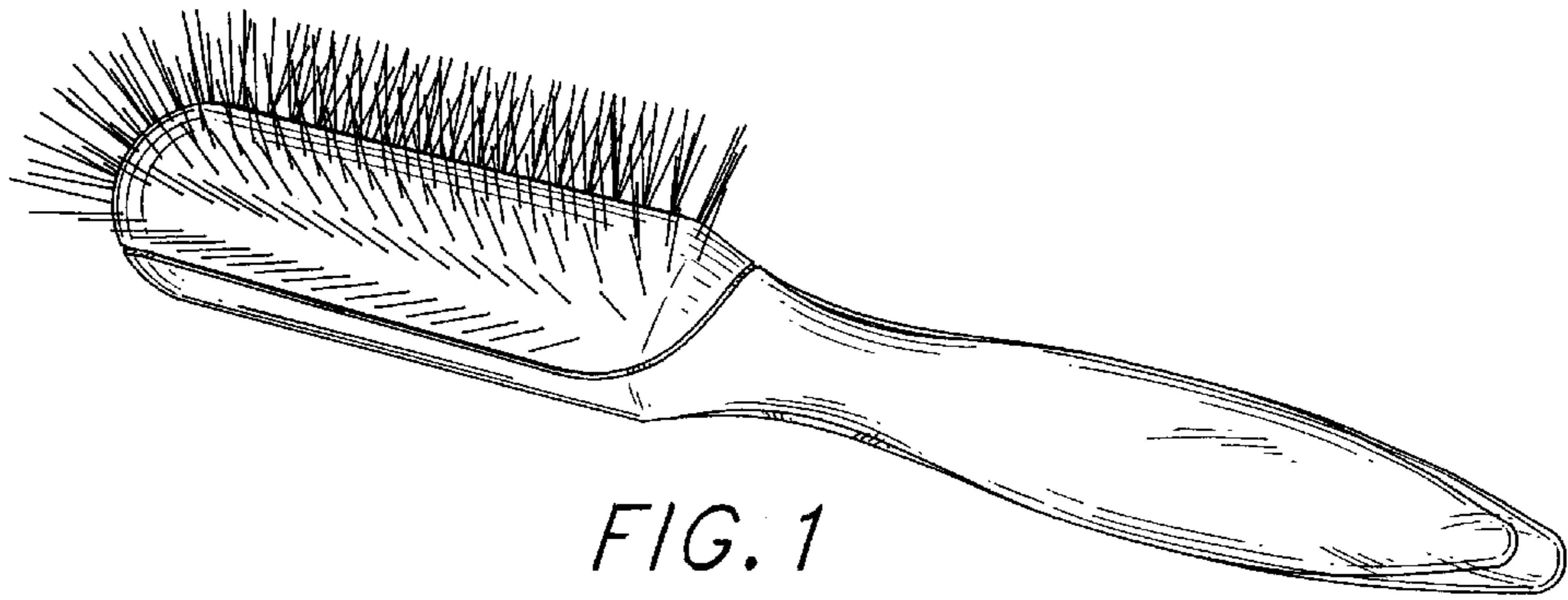

FIG. 1

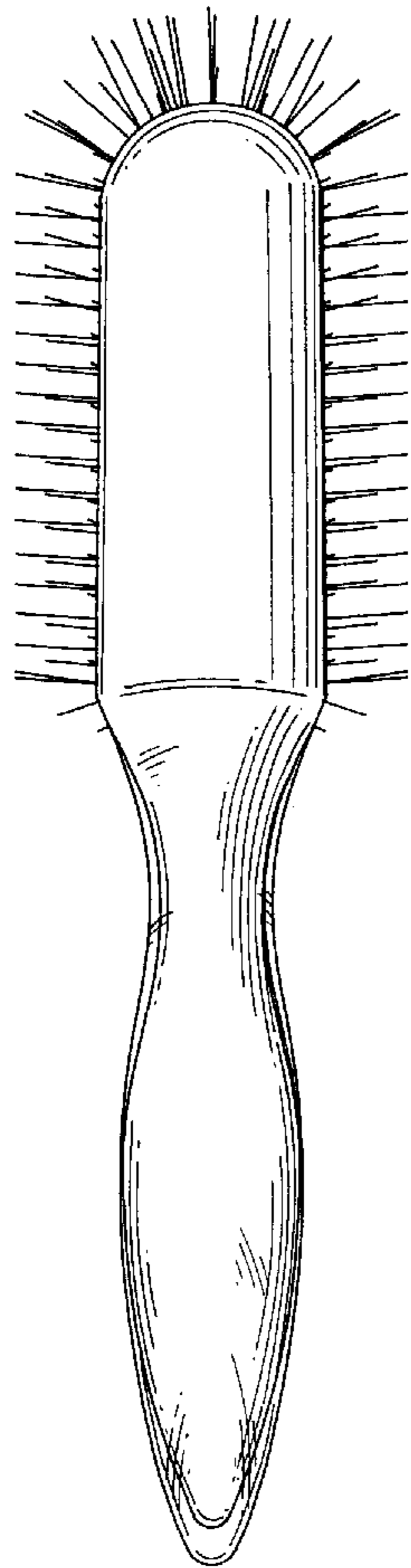

FIG. 3

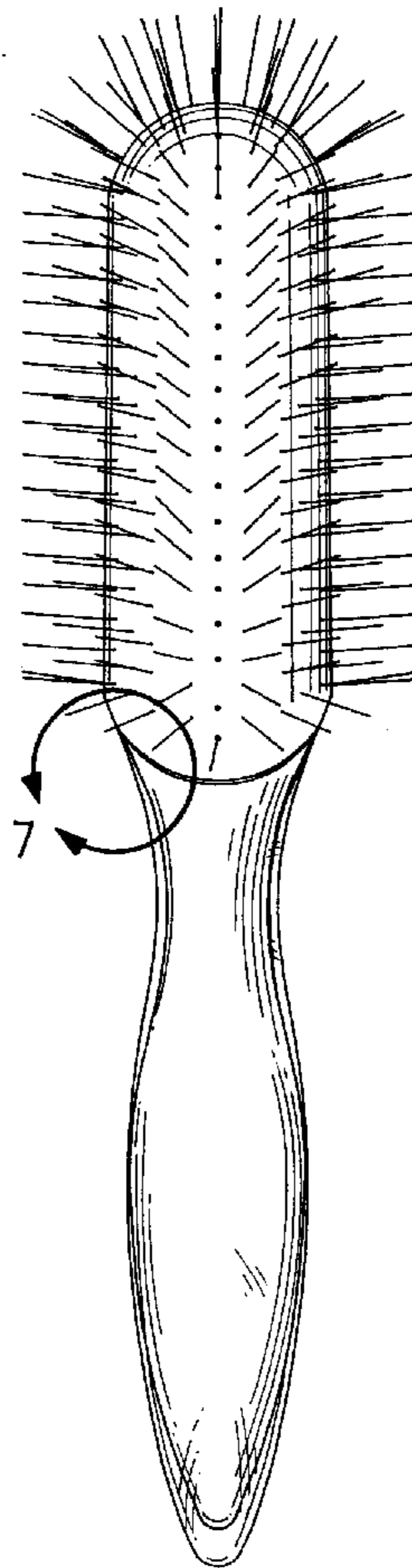

FIG. 2

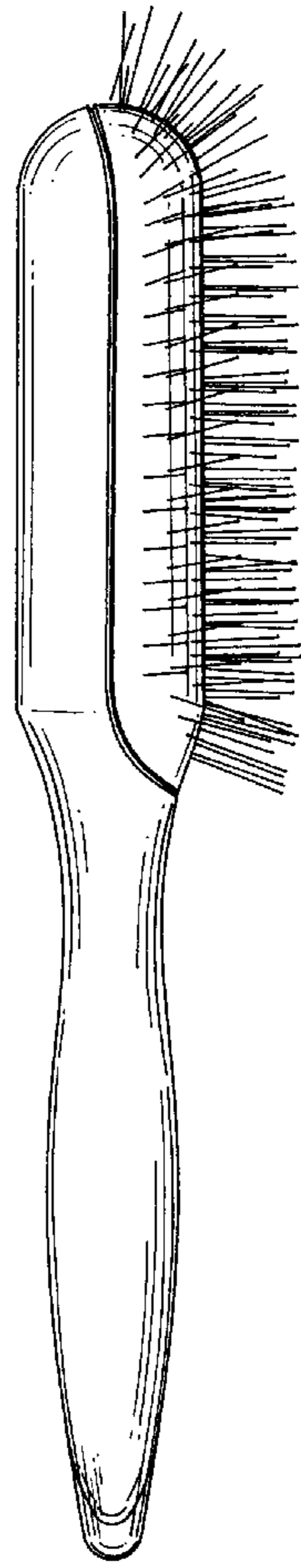

FIG. 4

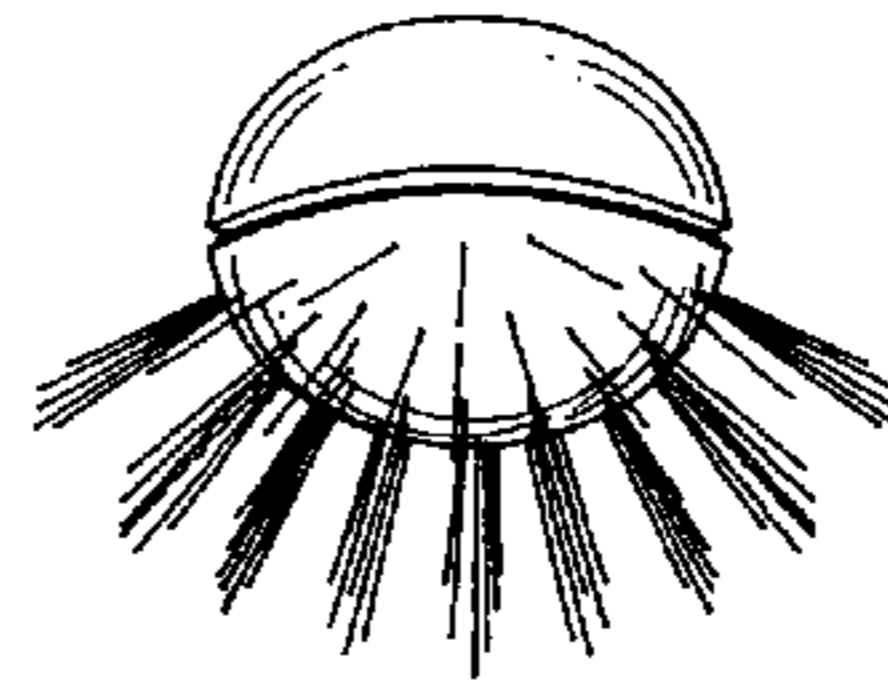

FIG. 5

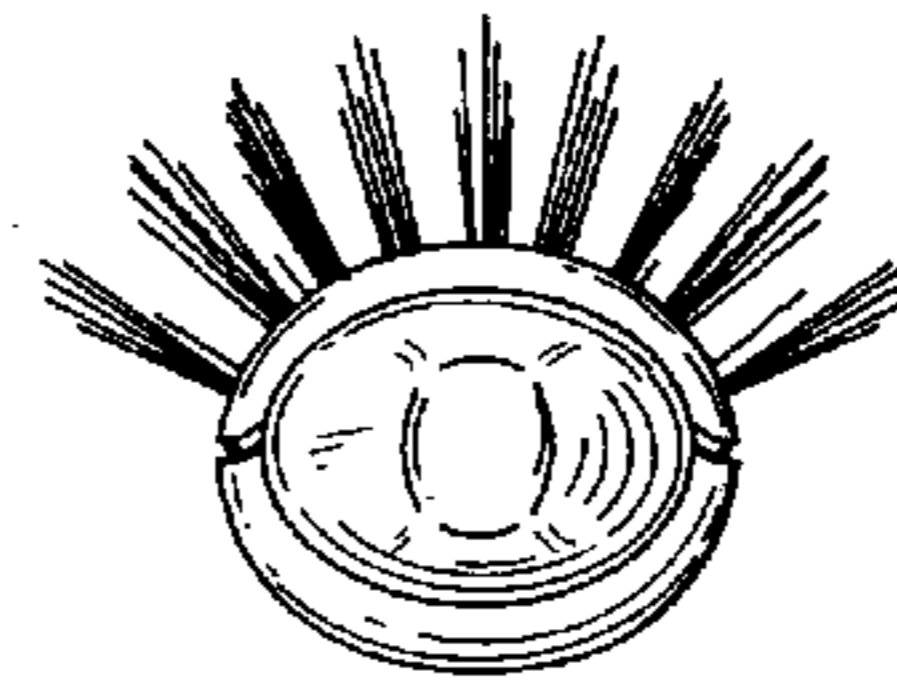

FIG. 6

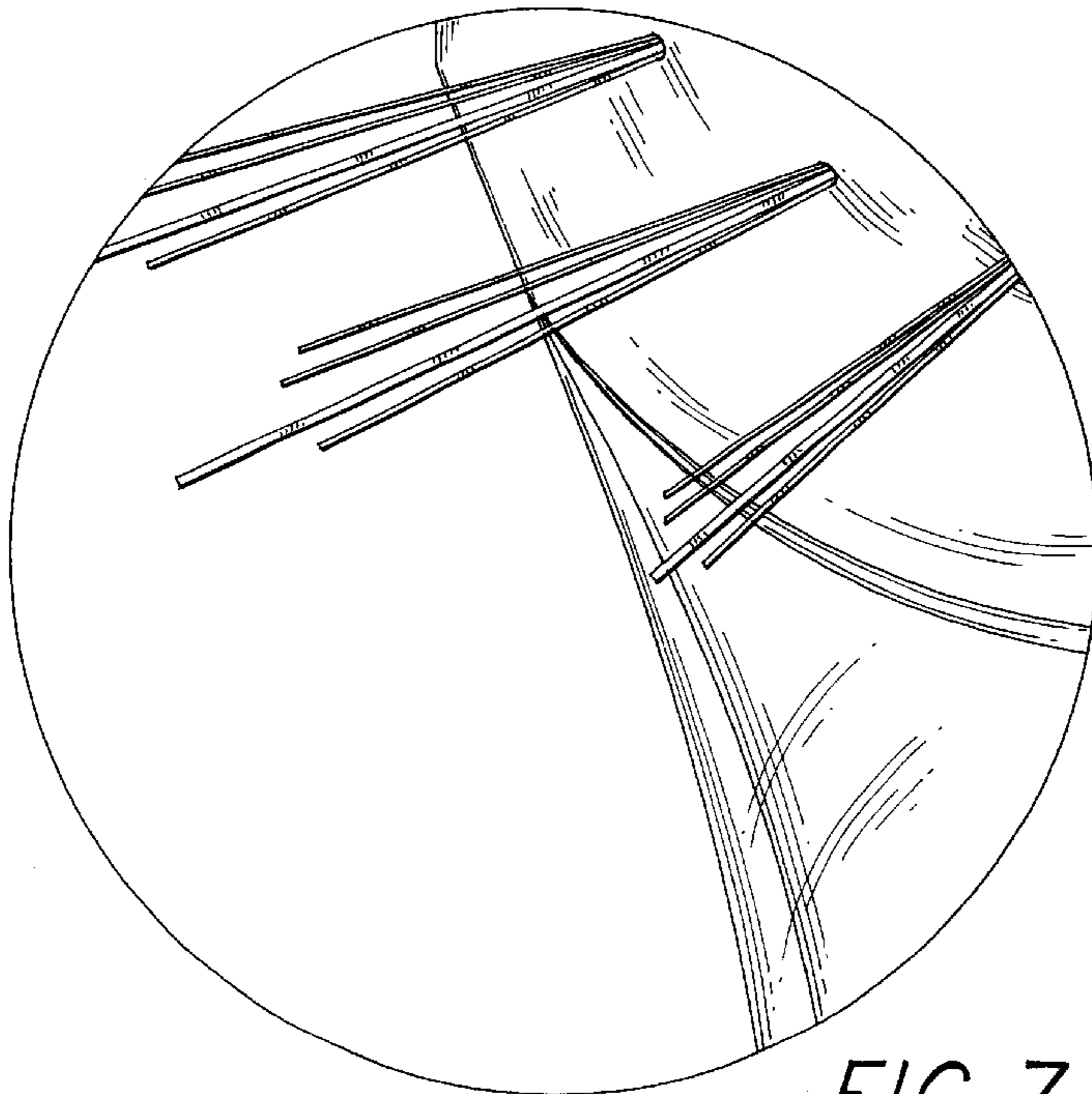

FIG. 7