



US00D483943S

(12) **United States Design Patent**
Ferrara, Jr.

(10) **Patent No.:** **US D483,943 S**

(45) **Date of Patent:** **** Dec. 23, 2003**

(54) **GOLF BAG**

D436,439 S * 1/2001 Dennesen et al. D3/255
D436,440 S * 1/2001 Stokes D3/255
D463,661 S * 10/2002 Mullen D3/255

(75) Inventor: **Daniel A. Ferrara, Jr.**, Morris, CT
(US)

* cited by examiner

(73) Assignee: **Mark Arzoomanian**, Alpine, NJ (US)

Primary Examiner—Philip S. Hyder

(**) Term: **14 Years**

(74) *Attorney, Agent, or Firm*—Cohen, Pontani, Lieberman
& Pavane

(21) Appl. No.: **29/175,757**

(57) **CLAIM**

(22) Filed: **Feb. 10, 2003**

The ornamental design for a golf bag, as shown and described.

(51) **LOC (7) Cl.** **03-01**

(52) **U.S. Cl.** **D3/255**

(58) **Field of Search** D3/254, 255, 279,
D3/282, 273, 276; 206/315.2, 315.3, 315.4,
315.5, 315.6, 315.7; 190/18 A; 280/47.26

DESCRIPTION

(56) **References Cited**

U.S. PATENT DOCUMENTS

D339,227 S * 9/1993 Fritze et al. D3/255
D349,402 S * 8/1994 Fiore D3/255
D360,296 S * 7/1995 Hunsaker D3/255
D375,405 S * 11/1996 Hunsaker D3/255
D385,418 S * 10/1997 Bisson D3/255
D394,950 S * 6/1998 Kite D3/255
D421,838 S * 3/2000 Bradshaw et al. D3/255

FIG. 1 is an elevated perspective view of a golf bag showing my new design;
FIG. 2 is a front view of the golf bag of FIG. 1;
FIG. 3 is a right side view of the golf bag of FIG. 1, the left side view being a mirror image thereof;
FIG. 4 is a rear view of the golf bag of FIG. 1;
FIG. 5 is a top plan view of the golf bag of FIG. 1;
FIG. 6 is a bottom plan view of the golf bag of FIG. 1; and,
FIG. 7 is an elevated perspective view of the golf bag of FIG. 1 showing the bag in the open condition.

1 Claim, 6 Drawing Sheets

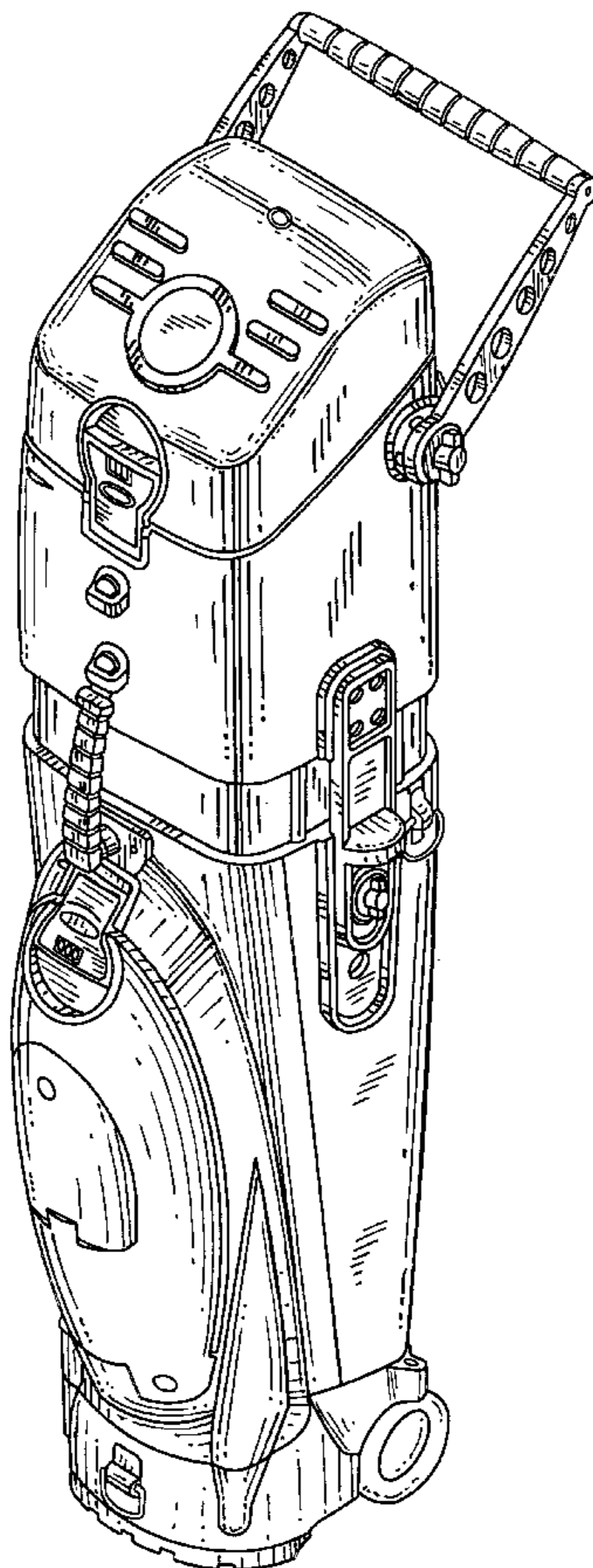

FIG. 1

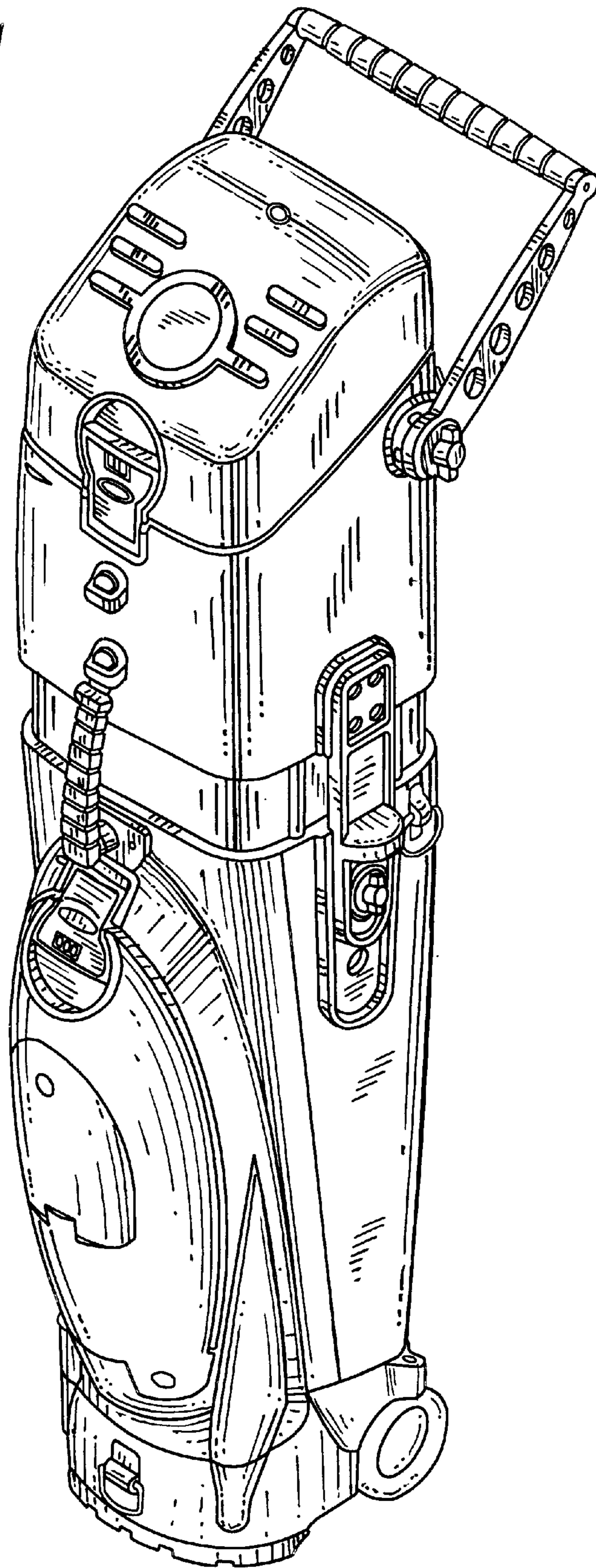

FIG. 2

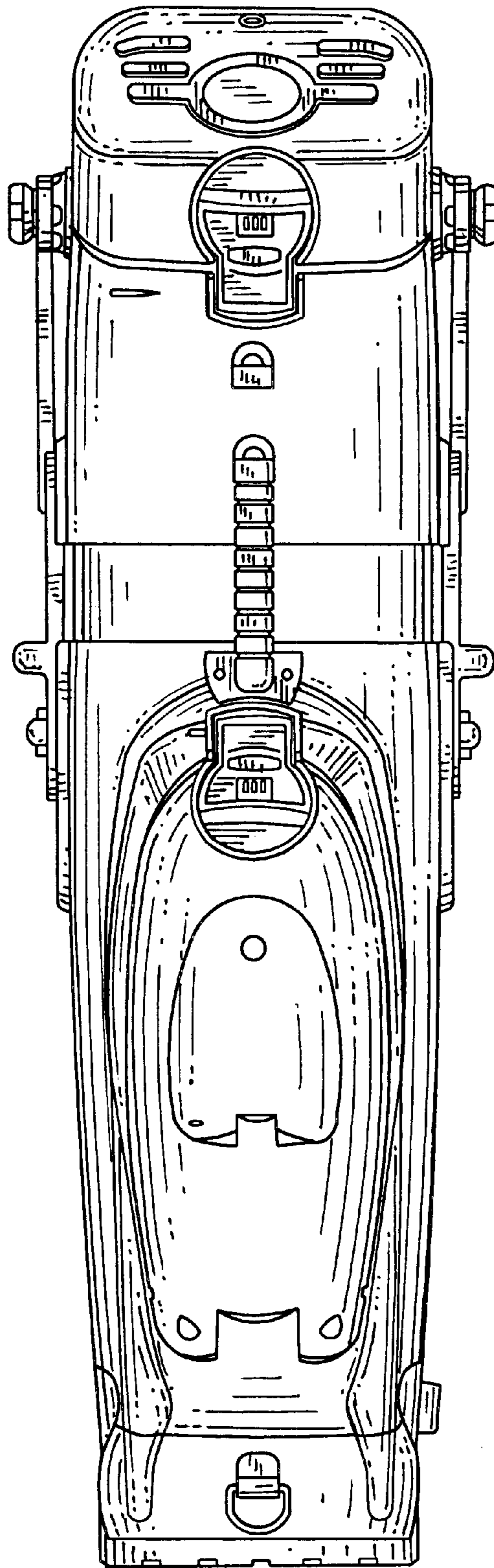

FIG. 3

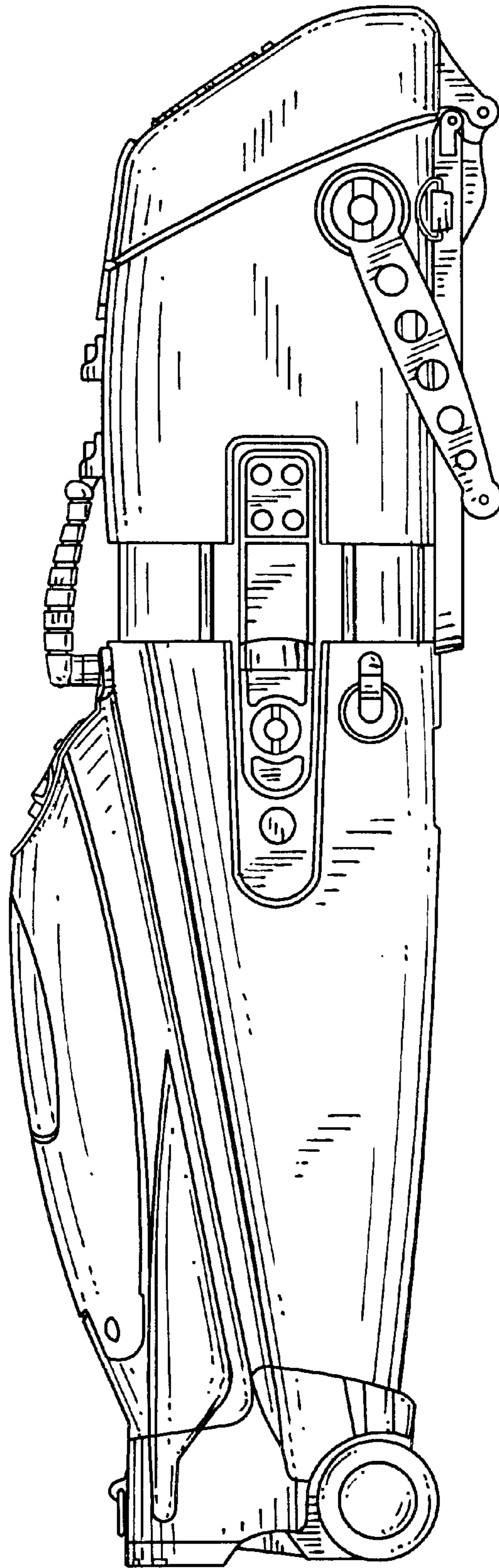
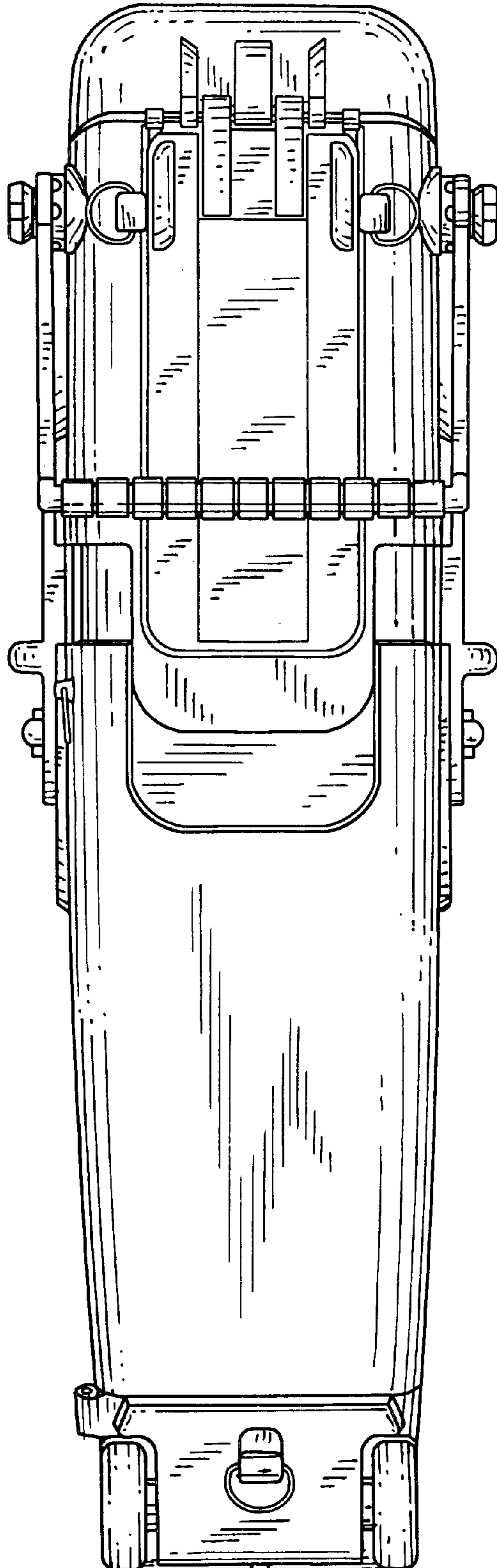

FIG. 4



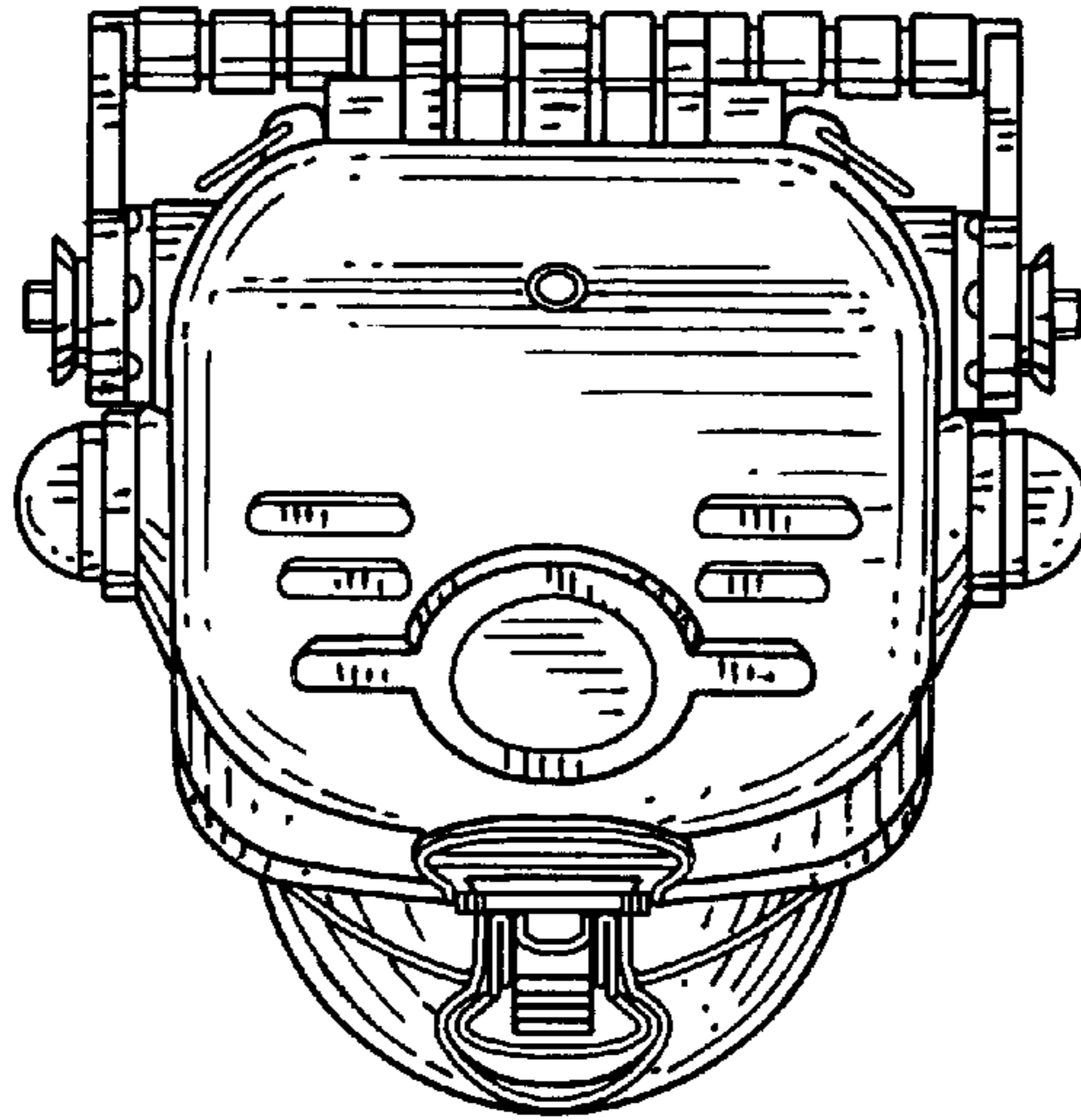

FIG. 5

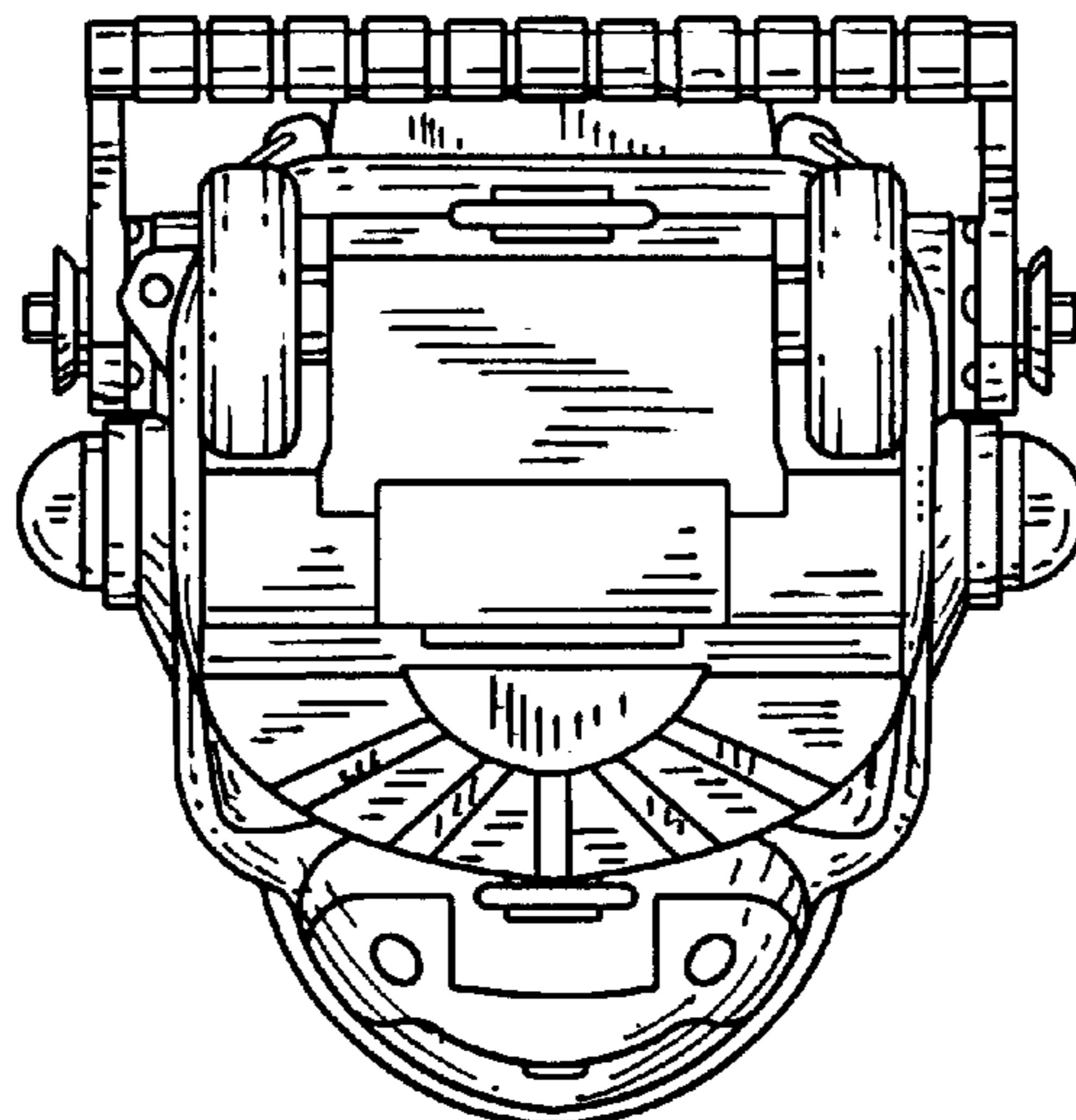

FIG. 6

FIG. 7

