



US00D483927S

(12) **United States Design Patent**
Appleberry

(10) **Patent No.:** **US D483,927 S**

(45) **Date of Patent:** **** Dec. 23, 2003**

(54) **DECORATIVE HAT**

(76) **Inventor:** **James Saiquan Appleberry, 53**
Grafton St., Rochester, NY (US) 14621

(**) **Term:** **14 Years**

(21) **Appl. No.:** **29/154,131**

(22) **Filed:** **Jan. 17, 2002**

(51) **LOC (7) Cl.** **02-03**

(52) **U.S. Cl.** **D2/882**

(58) **Field of Search** D2/865, 866, 872,
D2/874, 875, 876, 877, 879, 881, 882,
893, 894; 2/171, 181, 195.1, 195.2, 195.6,
209.12, 209.7

(56) **References Cited**

U.S. PATENT DOCUMENTS

1,134,515 A *	4/1915	Cphoon, Jr.	2/209.7
D90,101 S *	6/1933	Campbell	D2/882
D366,352 S *	1/1996	Shoemaker et al.	D2/874
D419,750 S *	2/2000	Bazin	D2/876
D424,282 S *	5/2000	Crumpton et al.	D2/876
D452,603 S	1/2002	Bunner, Jr.	
D453,261 S	2/2002	Pisarevsky	
D455,001 S	4/2002	Soergel	

* cited by examiner

Primary Examiner—Doris V. Coles

Assistant Examiner—Mimosa De

(74) *Attorney, Agent, or Firm*—Brian B. Shaw, Esq.; Donna P. Suchy, Esq.; Harter, Secrest & Emery LLP

(57) **CLAIM**

I claim the ornamental design for the decorative hat, as shown and described.

DESCRIPTION

FIG. 1 is a perspective view of a first embodiment of a decorative hat showing my new design;

FIG. 2 is a front elevational view thereof, with the decorative scarf not shown for ease of illustration;

FIG. 3 is a rear elevational view thereof, with the decorative scarf not shown for ease of illustration;

FIG. 4 is a side perspective view of a second embodiment of a decorative hat showing my new design;

FIG. 5 is a front elevational view thereof; with the decorative scarf not shown for ease of illustration; and,

FIG. 6 is a rear elevational view thereof; with the decorative scarf not shown for ease of illustration.

1 Claim, 2 Drawing Sheets

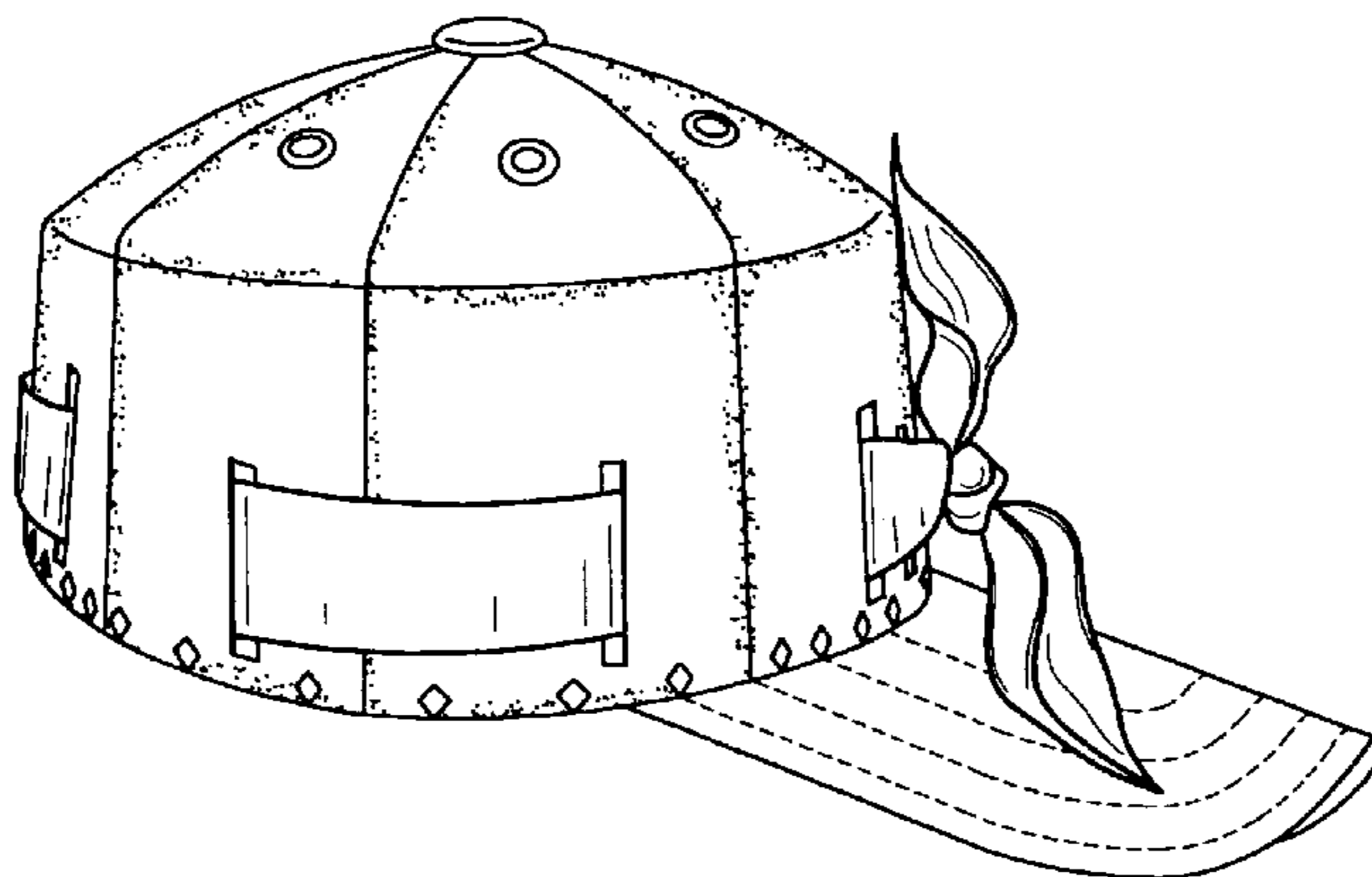
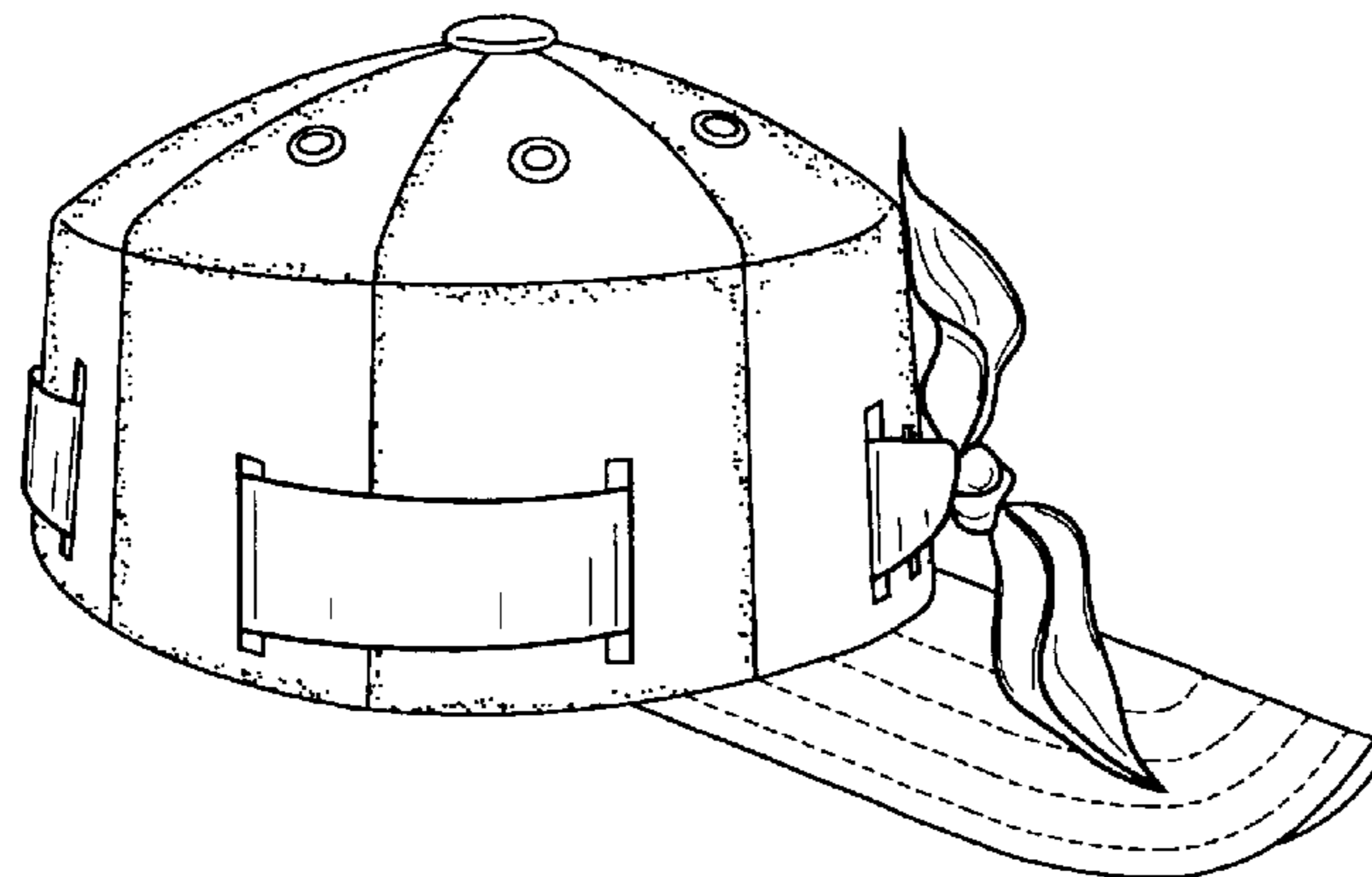

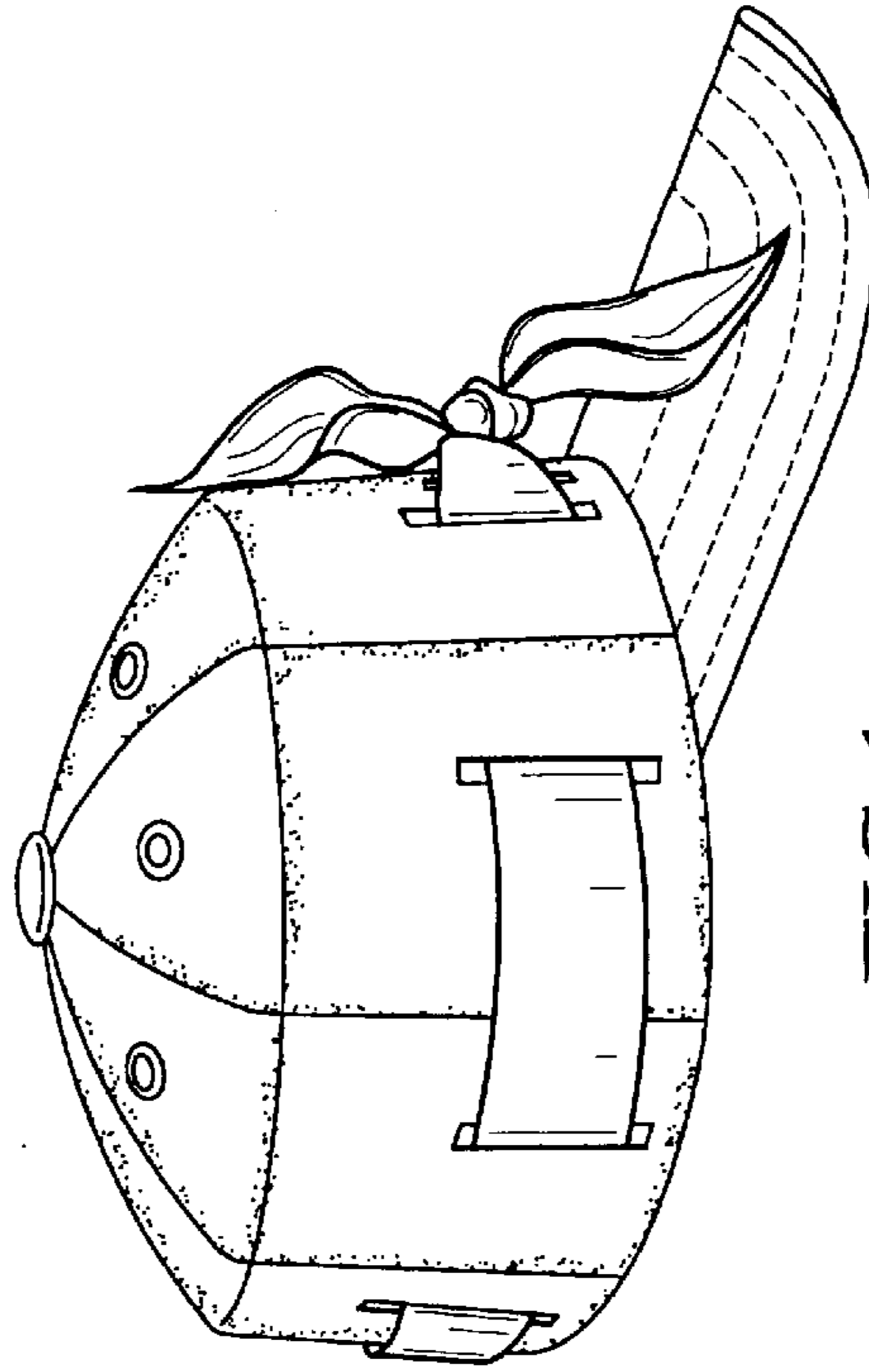

FIG. 1

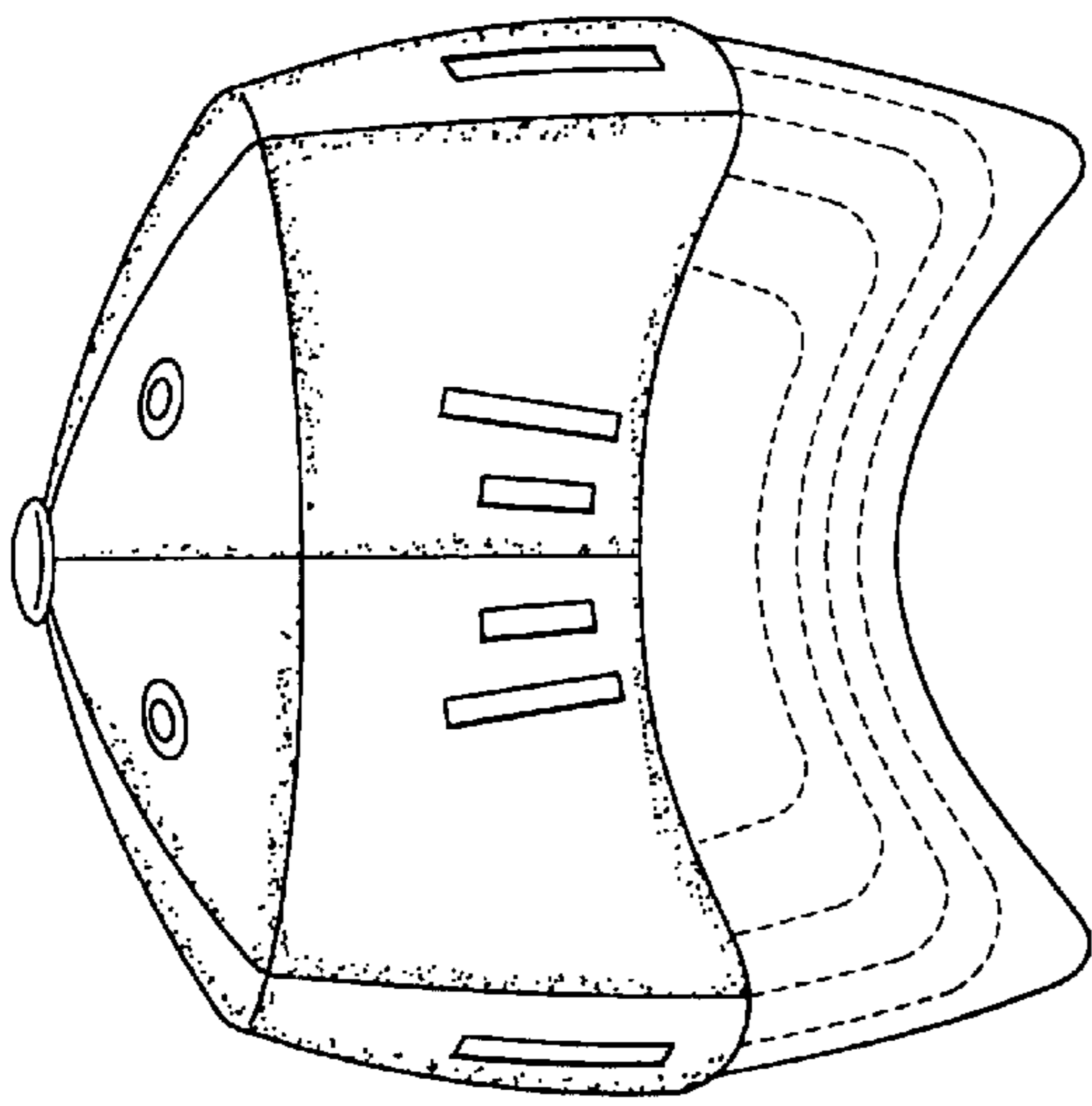

FIG. 2

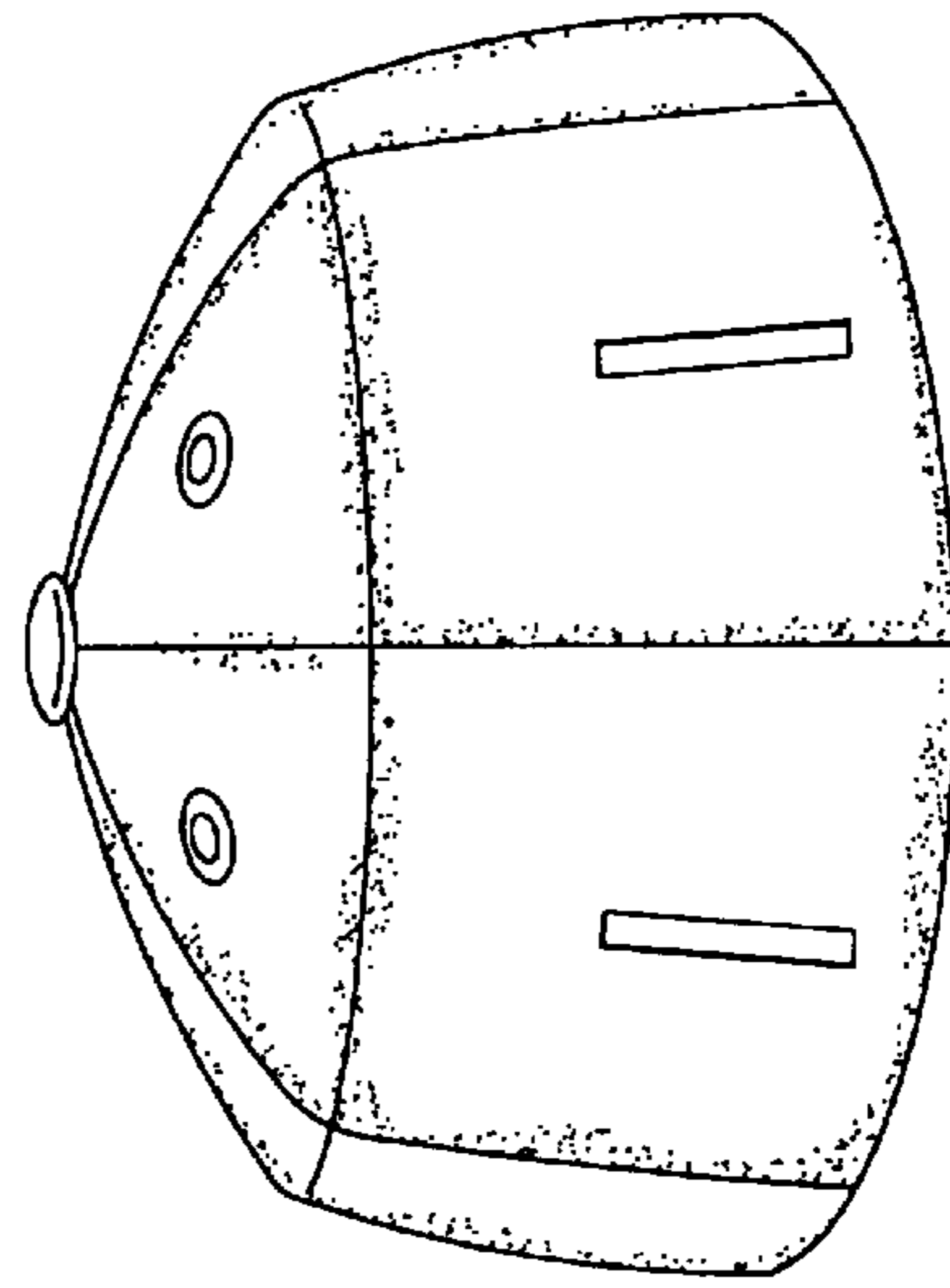

FIG. 3

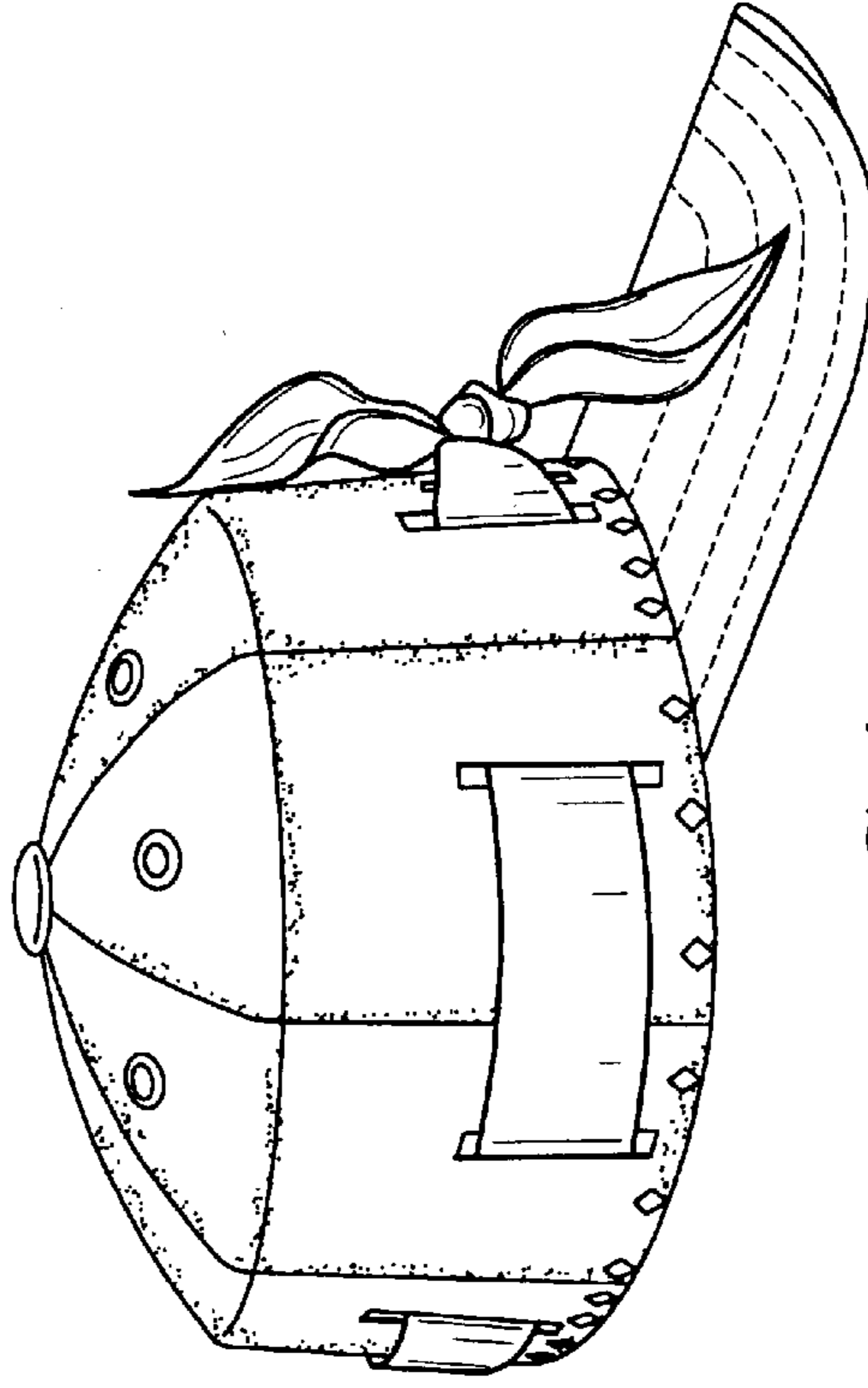

FIG. 4

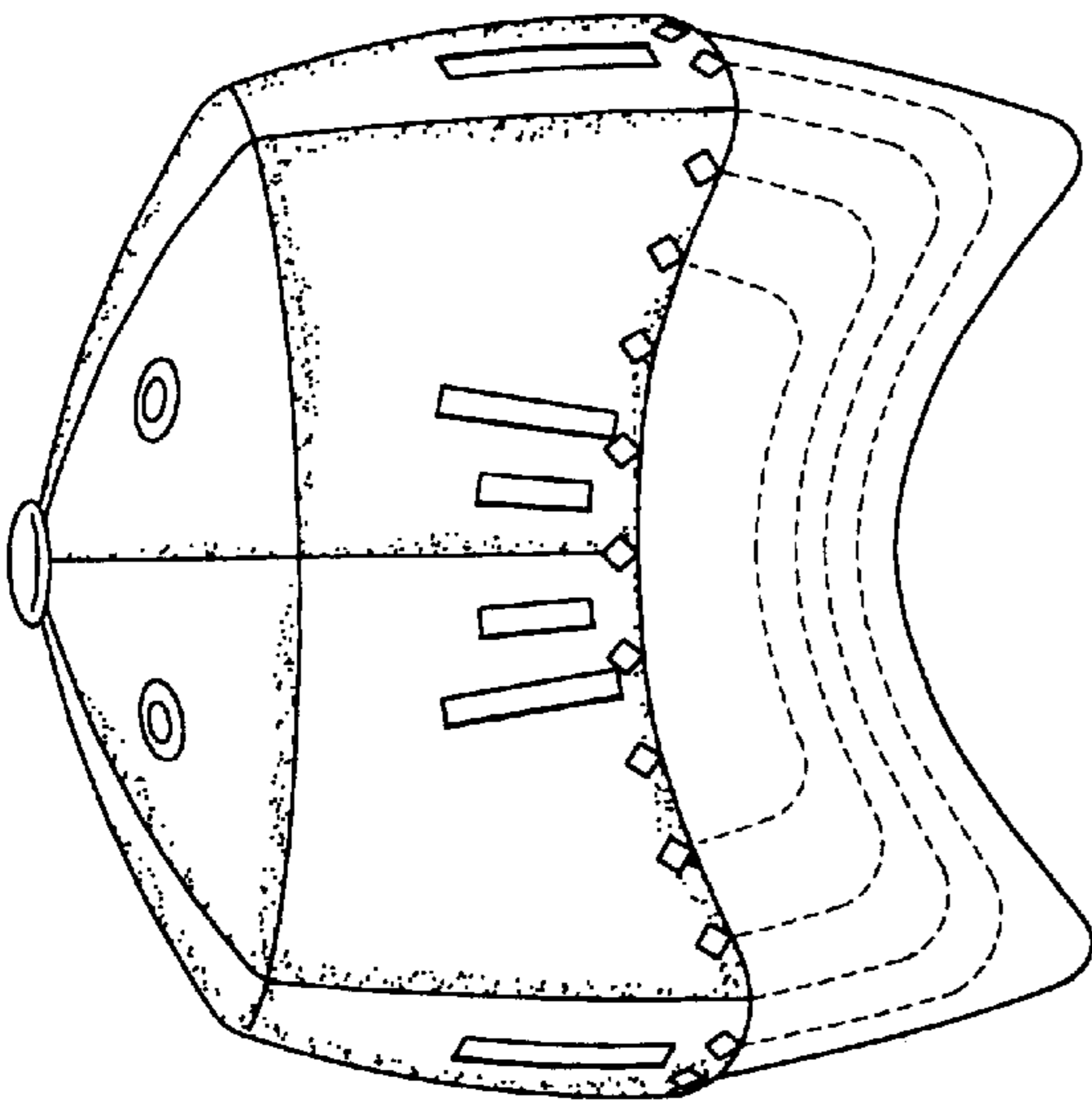

FIG. 5

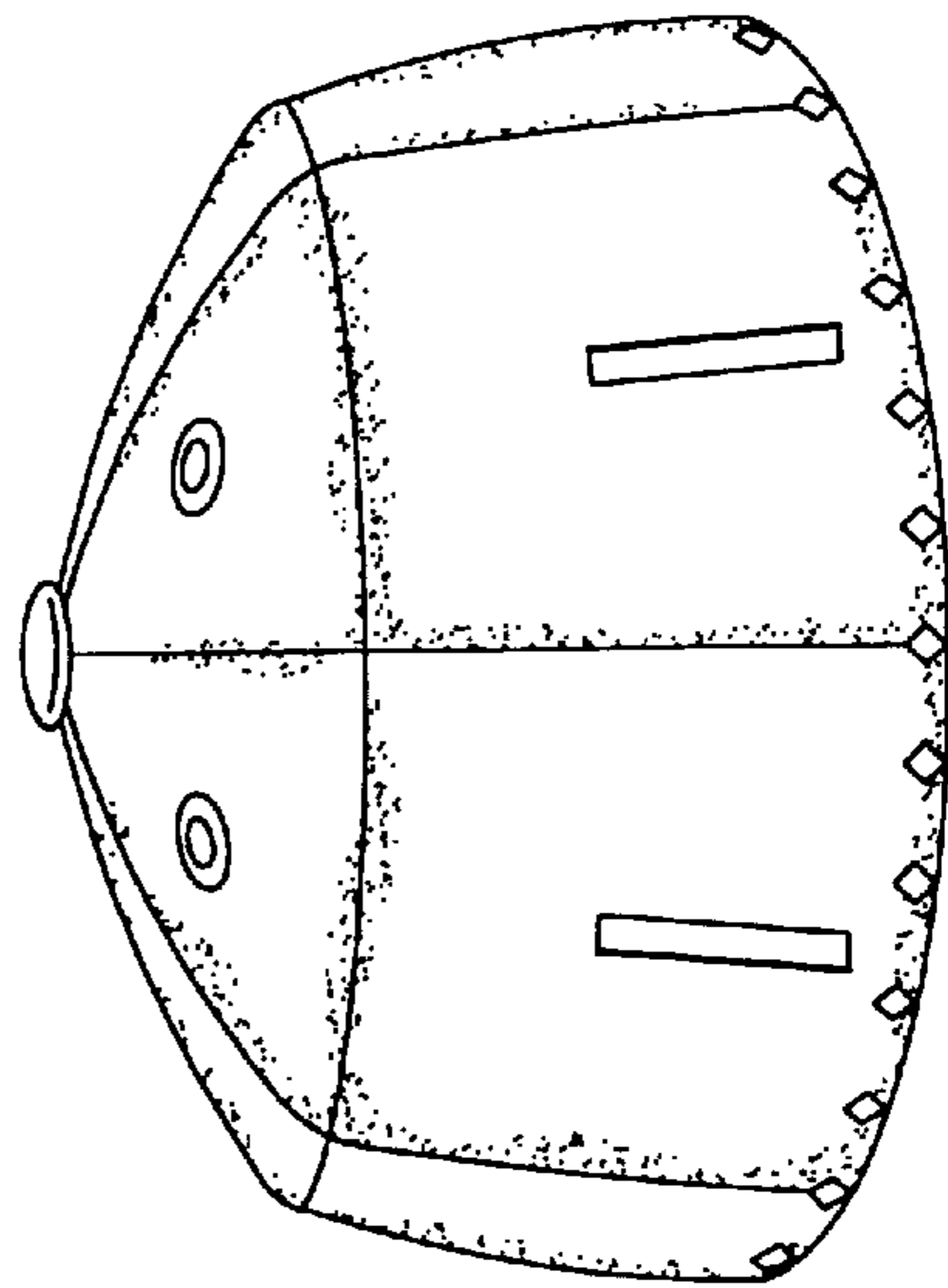

FIG. 6