



US00D483886S

(12) **United States Design Patent**
Horowitz

(10) **Patent No.:** **US D483,886 S**

(45) **Date of Patent:** **** Dec. 16, 2003**

(54) **TAIL LENS ASSEMBLY**

(75) Inventor: **Brian A. Horowitz**, Mission Viejo, CA (US)

(73) Assignee: **American Products Company, Inc.**, Corona, CA (US)

(**) Term: **14 Years**

(21) Appl. No.: **29/171,988**

(22) Filed: **Dec. 3, 2002**

Related U.S. Application Data

(63) Continuation of application No. 29/161,723, filed on Jun. 3, 2002, now Pat. No. Des. 469,554.

(51) **LOC (7) Cl.** **26-06**

(52) **U.S. Cl.** **D26/28**

(58) **Field of Search** D26/28-36, 120,
D26/122; 361/61, 80, 81, 82, 83, 83.4,
267, 269, 275

(56) **References Cited**

U.S. PATENT DOCUMENTS

D183,745 S 10/1958 Kenitz
D388,200 S 12/1997 Tomforde et al.
6,286,984 B1 9/2001 Berg

(List continued on next page.)

OTHER PUBLICATIONS

Photograph of rear view of 2000 Ford F-150; prior to Jun. 3, 2002.

Photograph of rear view of 2000 Ford F-150 Flareside; prior to Jun. 3, 2002.

Advertisement for Z2000 Sportlights; prior to Jun. 3, 2002.

American Products Company, 2001 catalog, pp. 12-13.

(List continued on next page.)

Primary Examiner—Marcus A. Jackson

(74) *Attorney, Agent, or Firm*—Knobbe, Martens, Olson & Bear LLP

(57) **CLAIM**

The ornamental design for a tail lens assembly, as shown and described.

DESCRIPTION

FIG. 1 is a front-right perspective view of a preferred embodiment of the tail lens assembly according to the present design;

FIG. 2 is a front-right perspective view of another preferred embodiment of the tail lens assembly according to the present design;

FIG. 3 is a partially exploded front-right perspective view of the tail lens assembly of FIG. 1, illustrating the cover of the tail lens assembly removed;

FIG. 4 is a partially exploded front-right perspective view of the tail lens assembly of FIG. 2, illustrating the cover of the tail lens assembly removed;

FIG. 5 is a front elevational view of the tail lens assembly of FIG. 1;

FIG. 6 is a front elevational view of the tail lens assembly of FIG. 2;

FIG. 7 is a right-side elevational view of the tail lens assembly of FIG. 1;

FIG. 8 is a right-side elevational view of the tail lens assembly of FIG. 2;

FIG. 9 is a top plan view of the tail lens assembly of FIG. 1;

FIG. 10 is a top plan view of the tail lens assembly of FIG. 2;

FIG. 11 is a front-right perspective view of the tail lens assembly of FIG. 1 showing the lens assembly installed on a vehicle; and,

FIG. 12 is a front-right perspective view of the tail lens assembly of FIG. 2 showing the lens assembly installed on a vehicle.

Phantom lining, where used, is for illustrative purposes only and is not intended to limit the claimed design to the features shown in phantom.

1 Claim, 8 Drawing Sheets

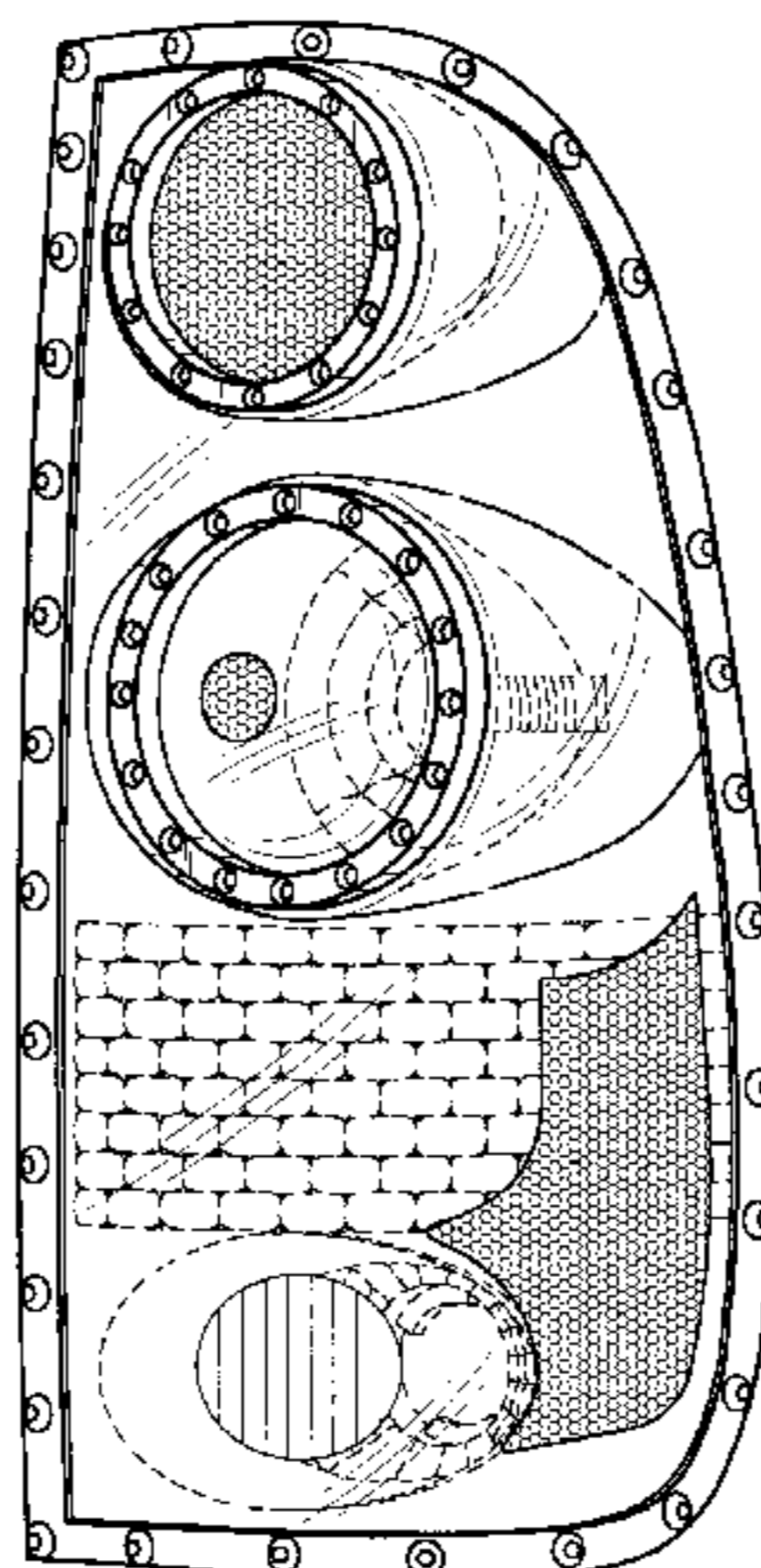

U.S. PATENT DOCUMENTS

D449,898 S 10/2001 Horowitz
6,296,382 B1 10/2001 Hamelbeck
D456,919 S 5/2002 Horowitz
D458,701 S 6/2002 Horowitz
D460,205 S 7/2002 Horowitz
D460,833 S 7/2002 Horowitz
D467,019 S * 12/2002 Horowitz D26/28
D472,996 S * 4/2003 Horowitz D26/28
D473,666 S * 4/2003 Horowitz D26/28

OTHER PUBLICATIONS

CaliforniaStylin.com Advertisement, Mini Trucking maga-
zine, Nov. 2001.
Toucan Industries, Inc., 2001–2002 catalog, p. 27.
Hiper Industries, 2002 catalog, p. 4.
Advertisement for Stillen Sports Cars, from Sport Compact
Car, vol. 13, No. 03, pp. 58–59, Mar. 2001.
* cited by examiner

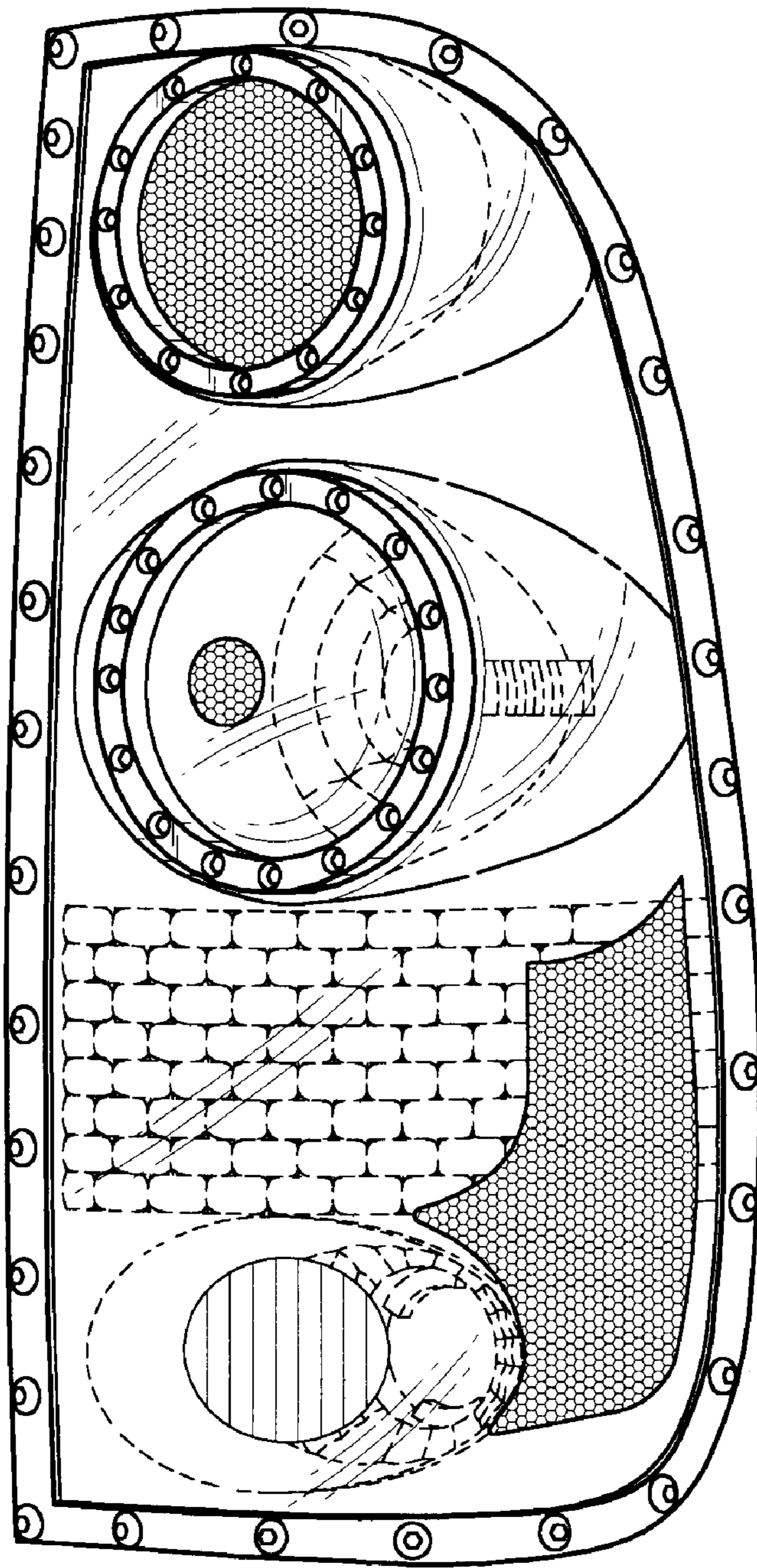

FIG. 1

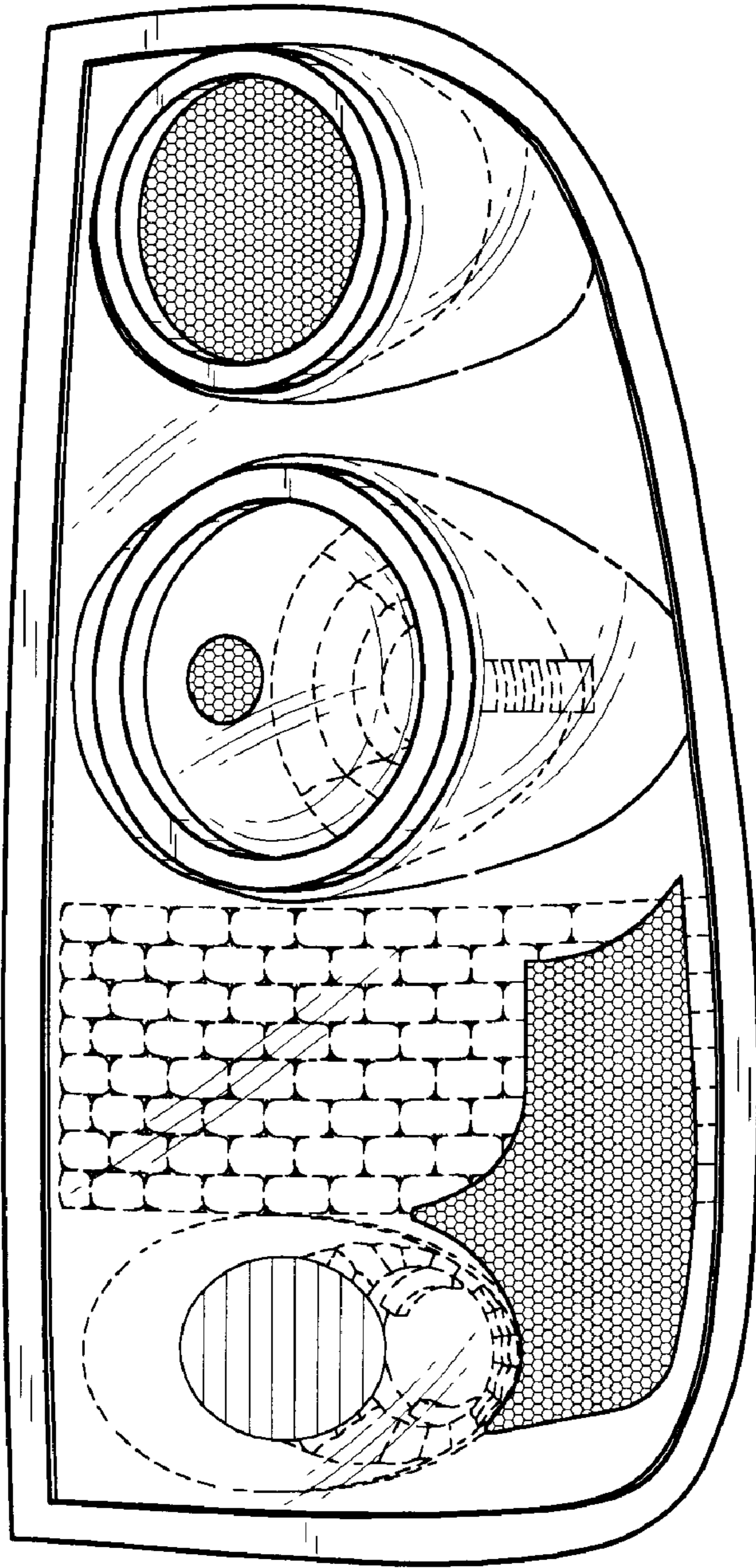

FIG. 2

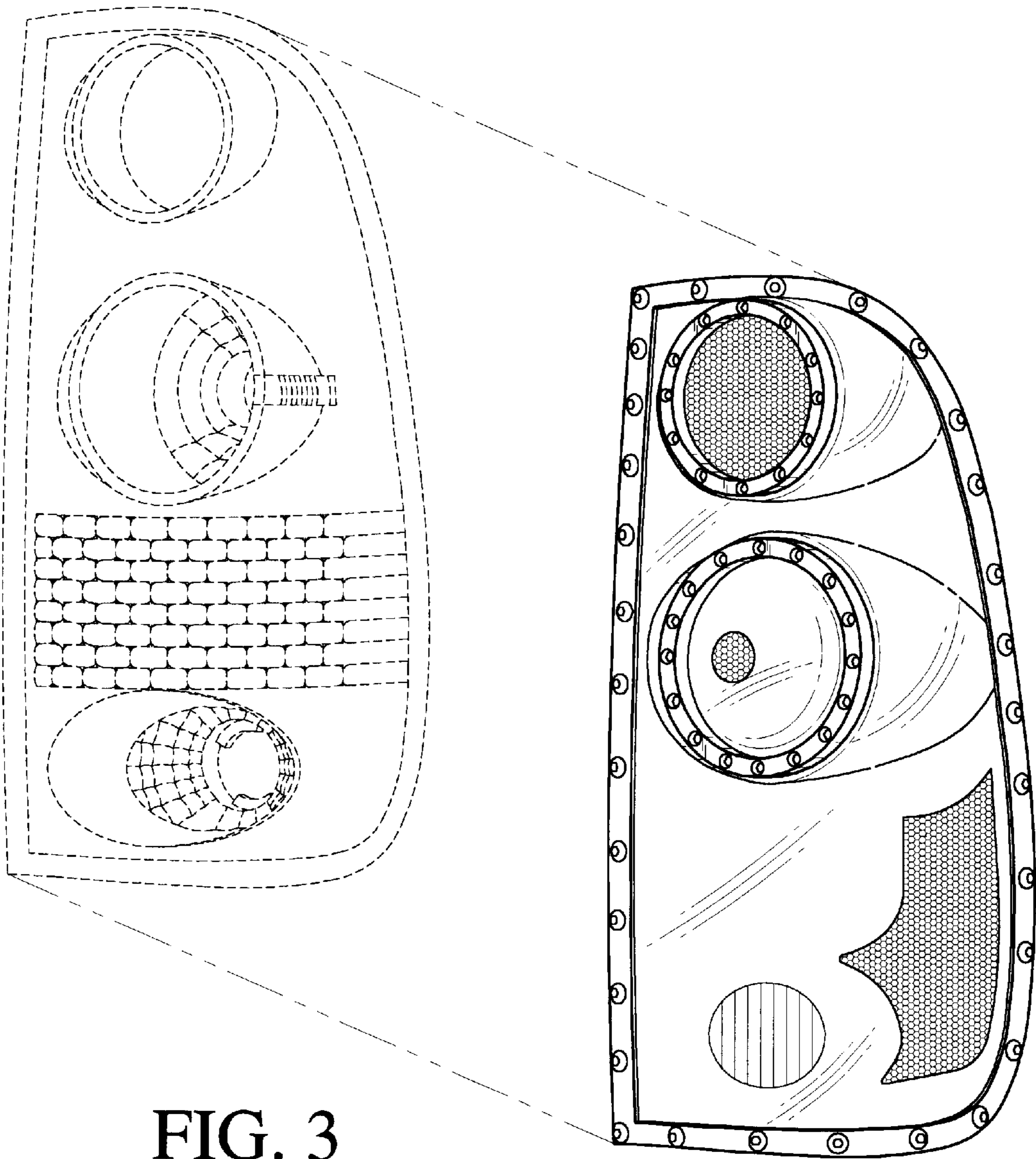

FIG. 3

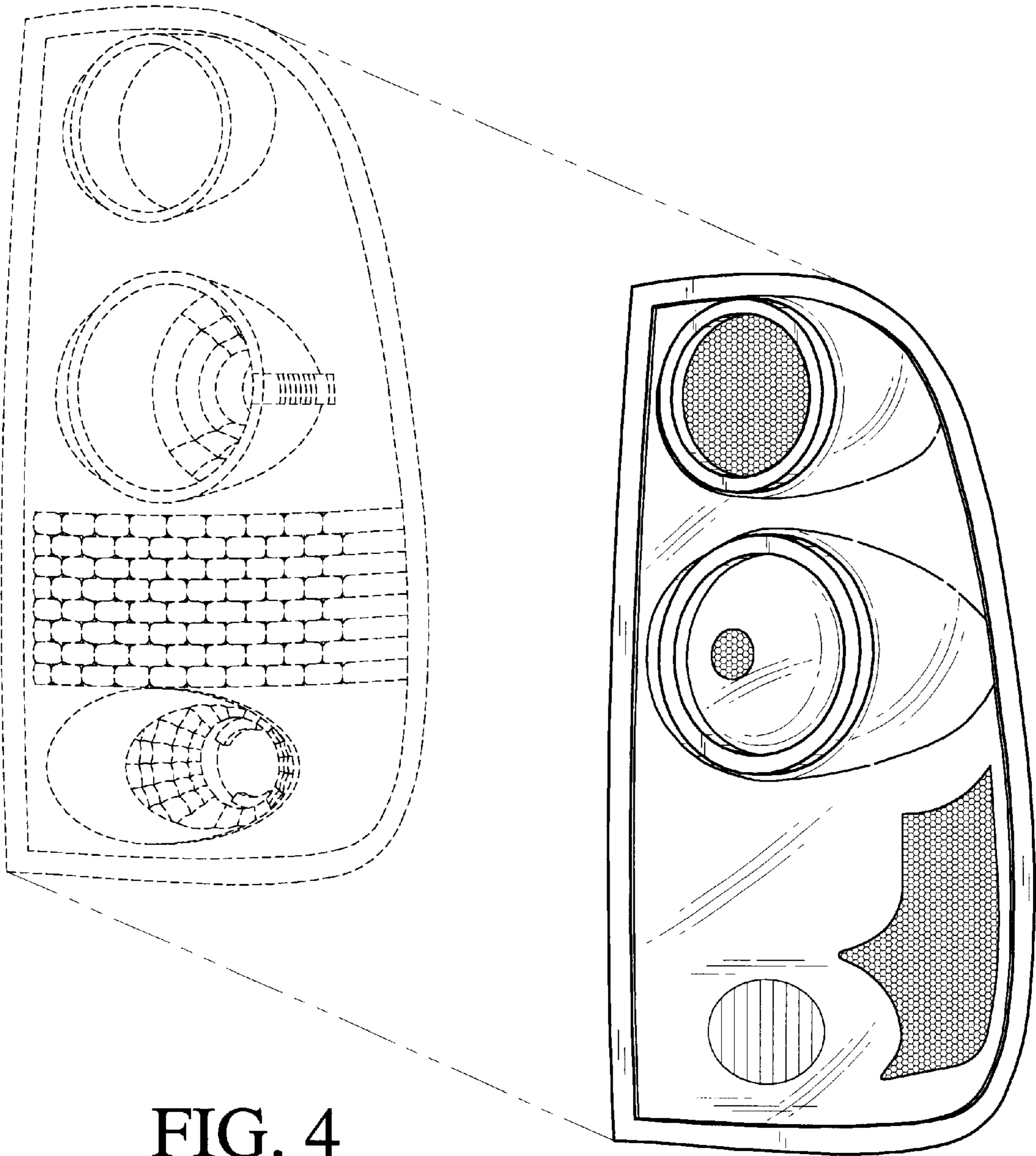

FIG. 4

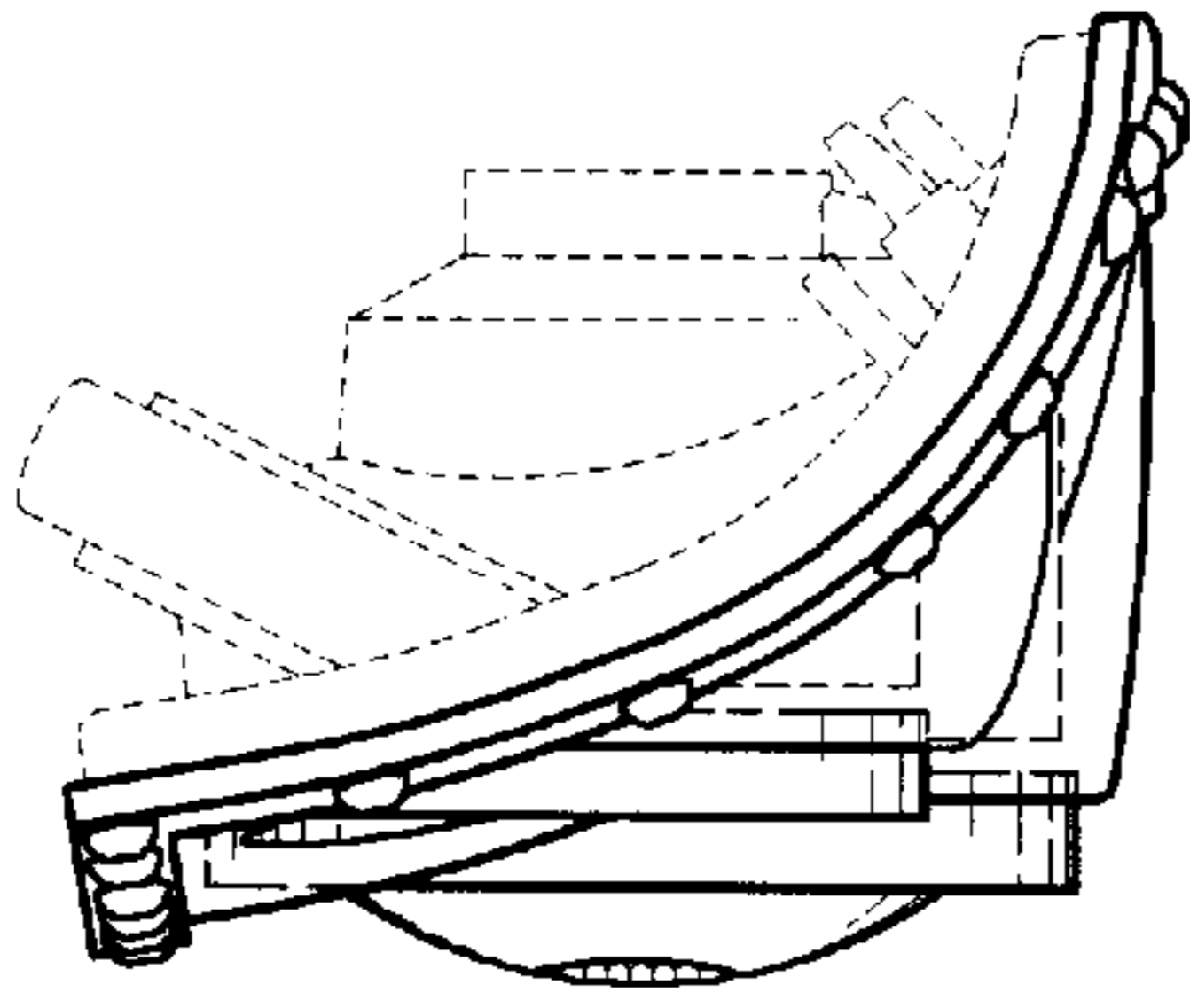

FIG. 9

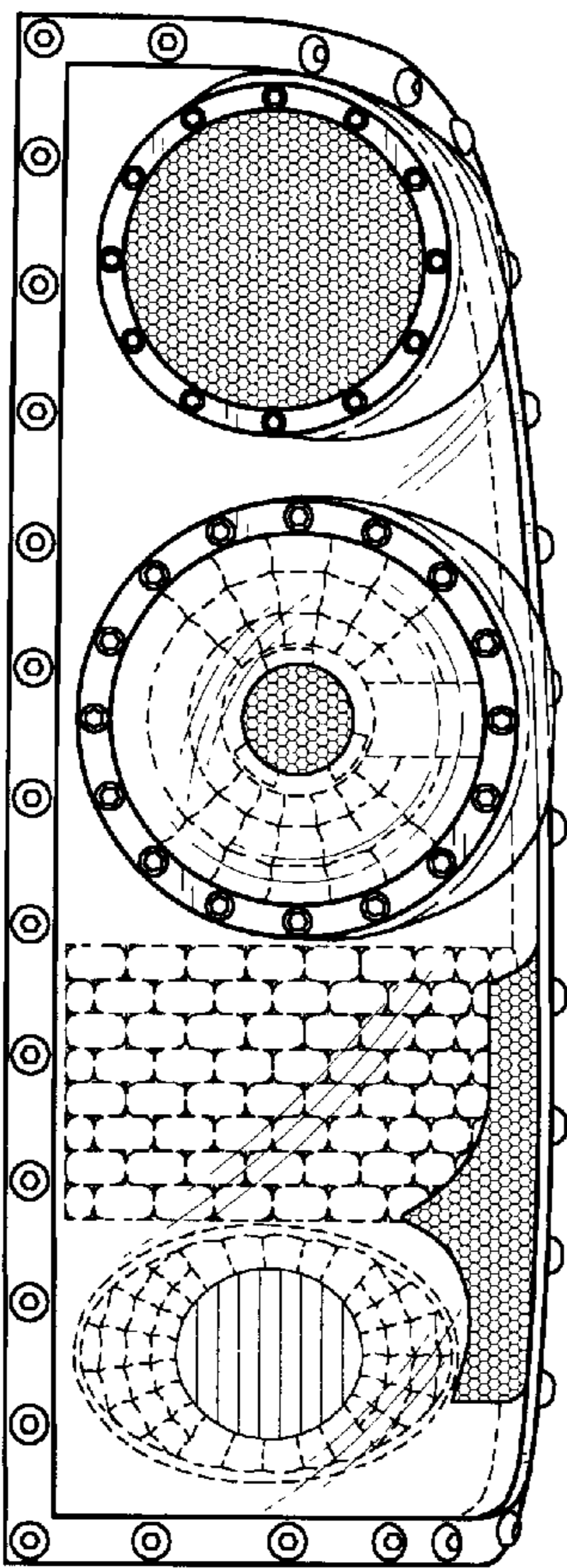

FIG. 5

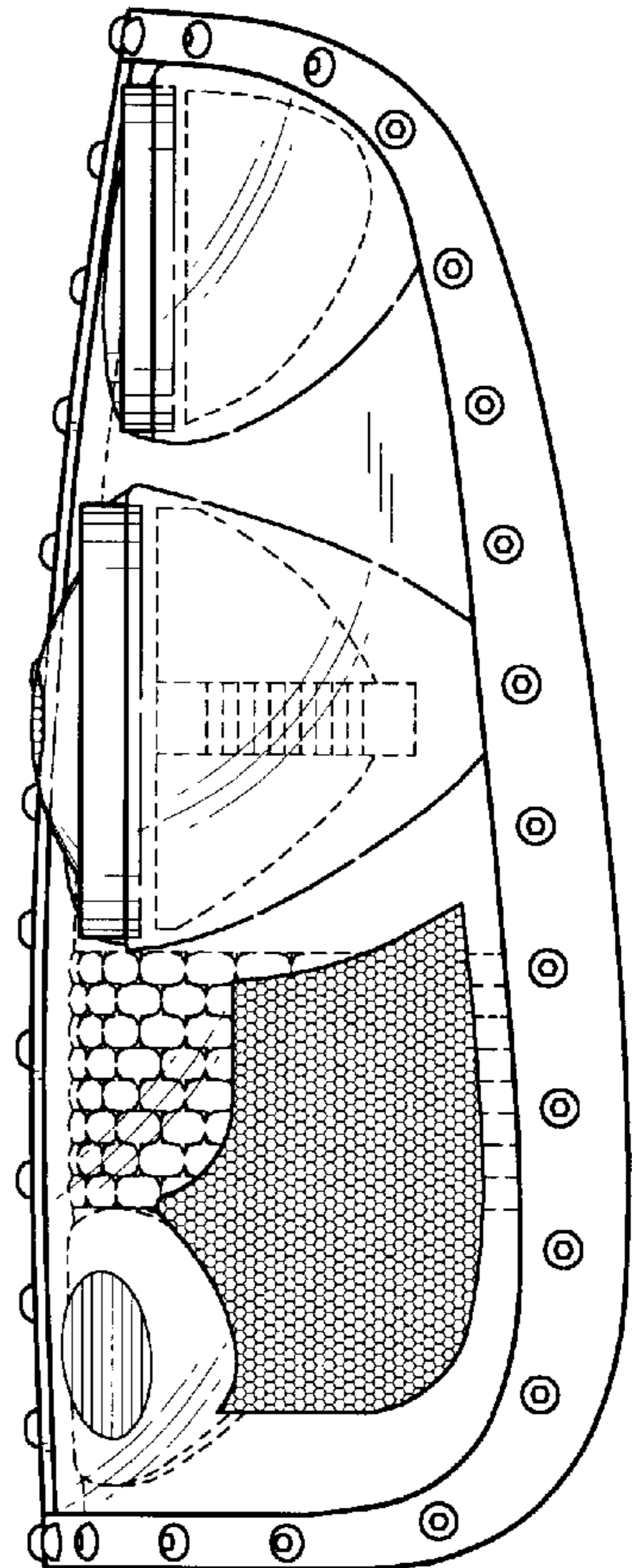

FIG. 7

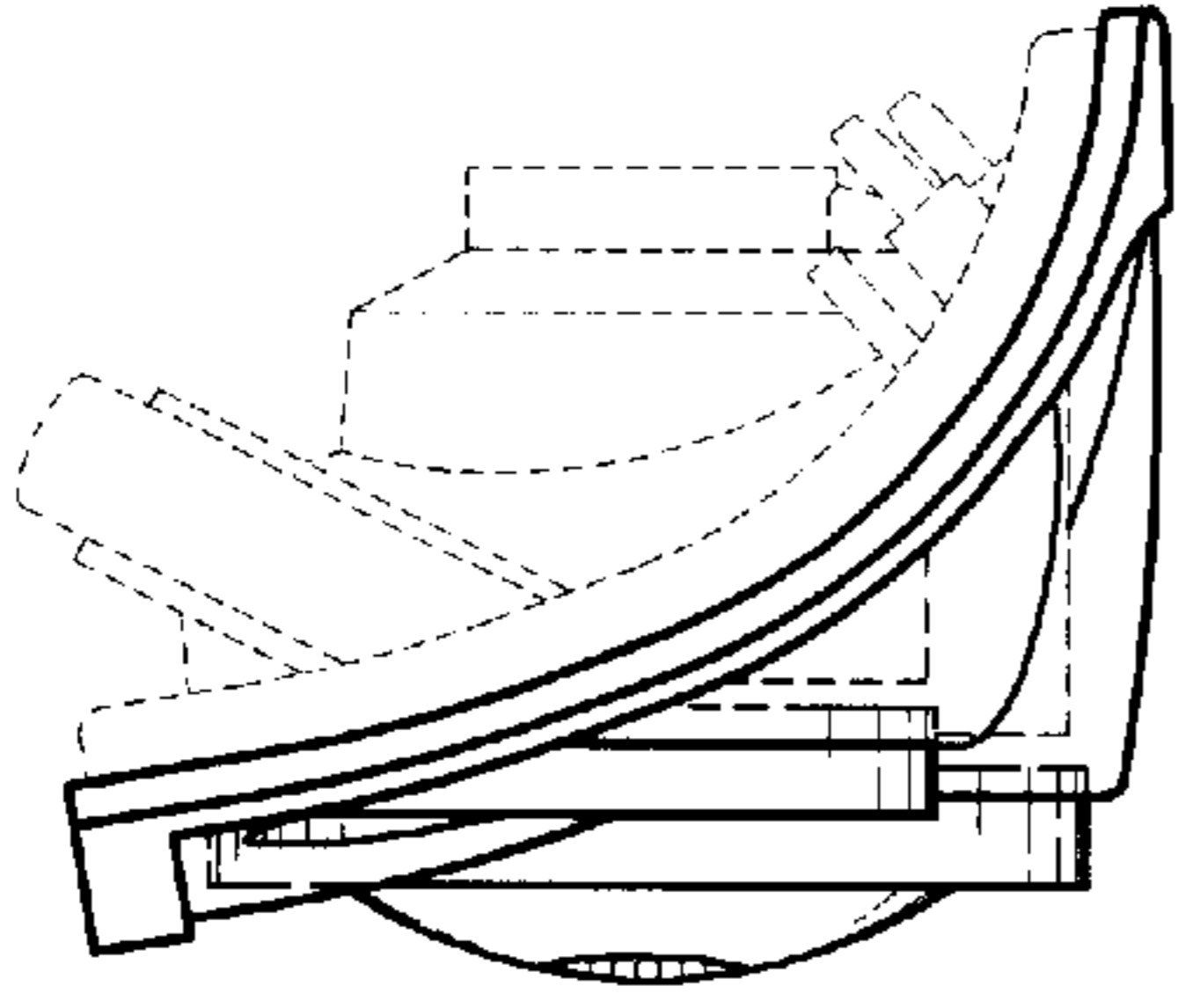

FIG. 10

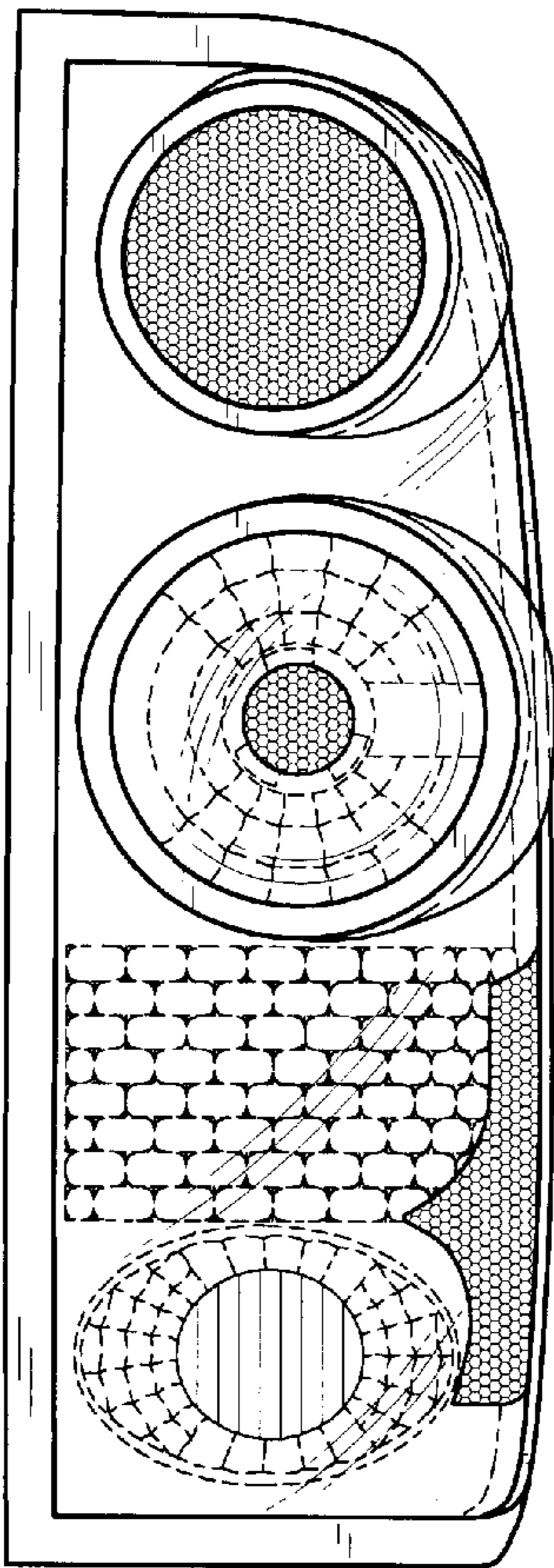

FIG. 6

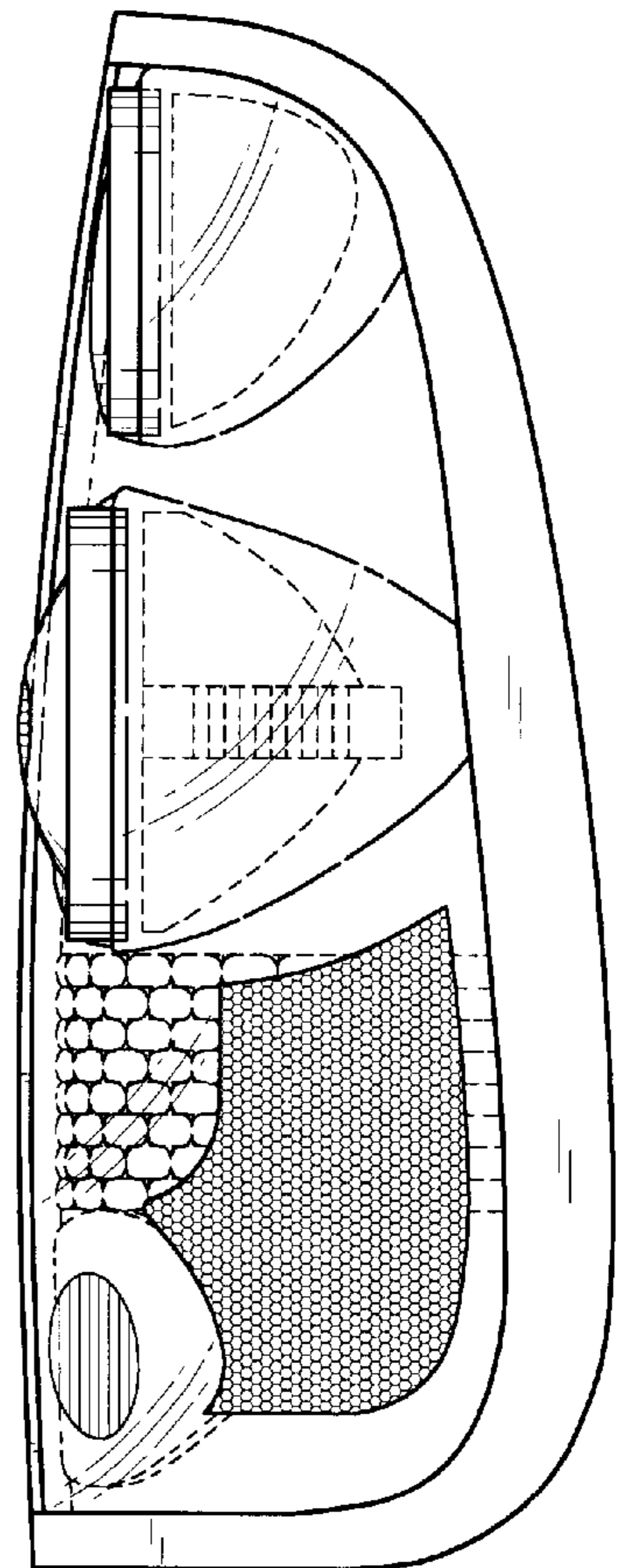

FIG. 8

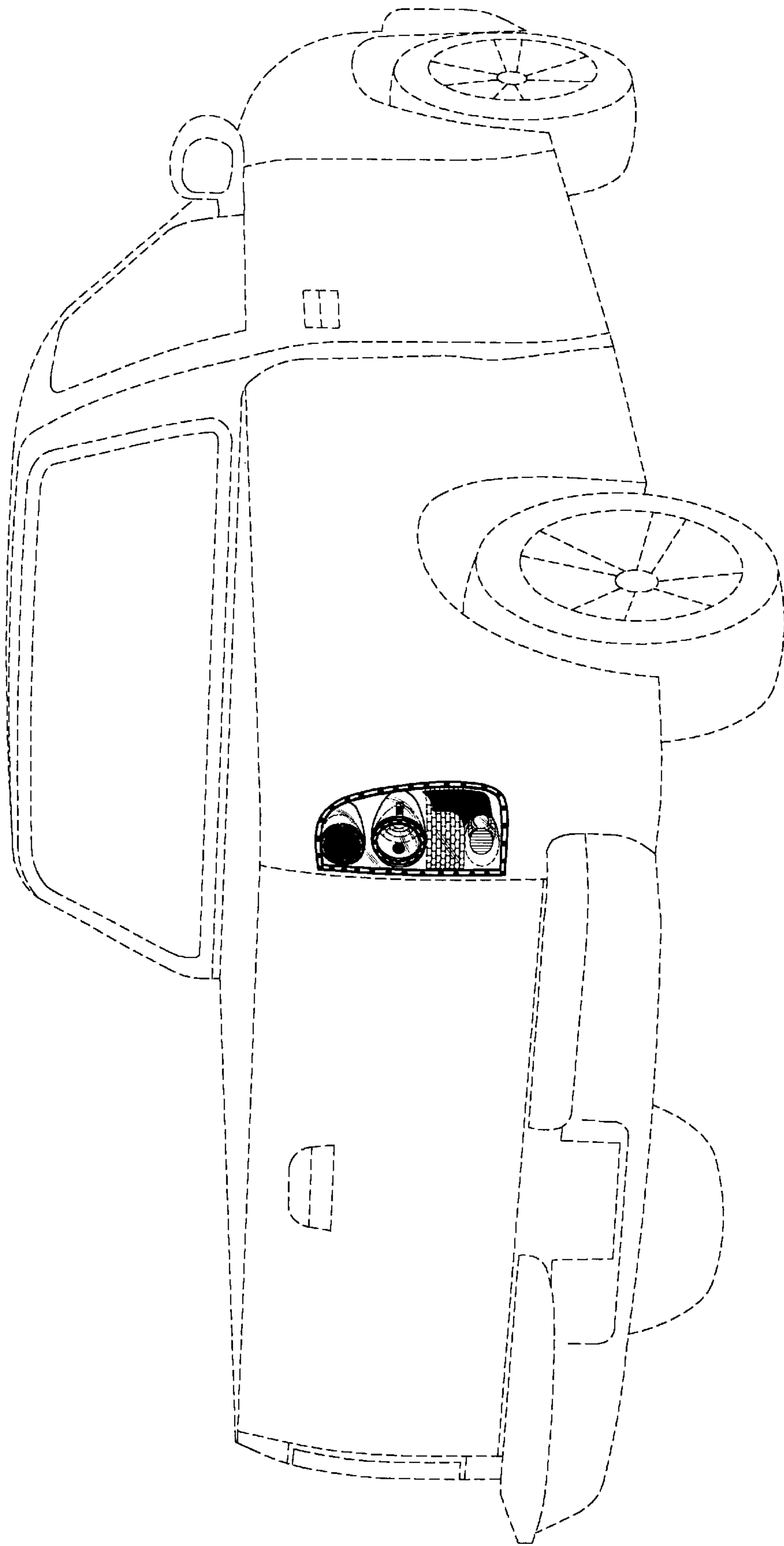

FIG. 11

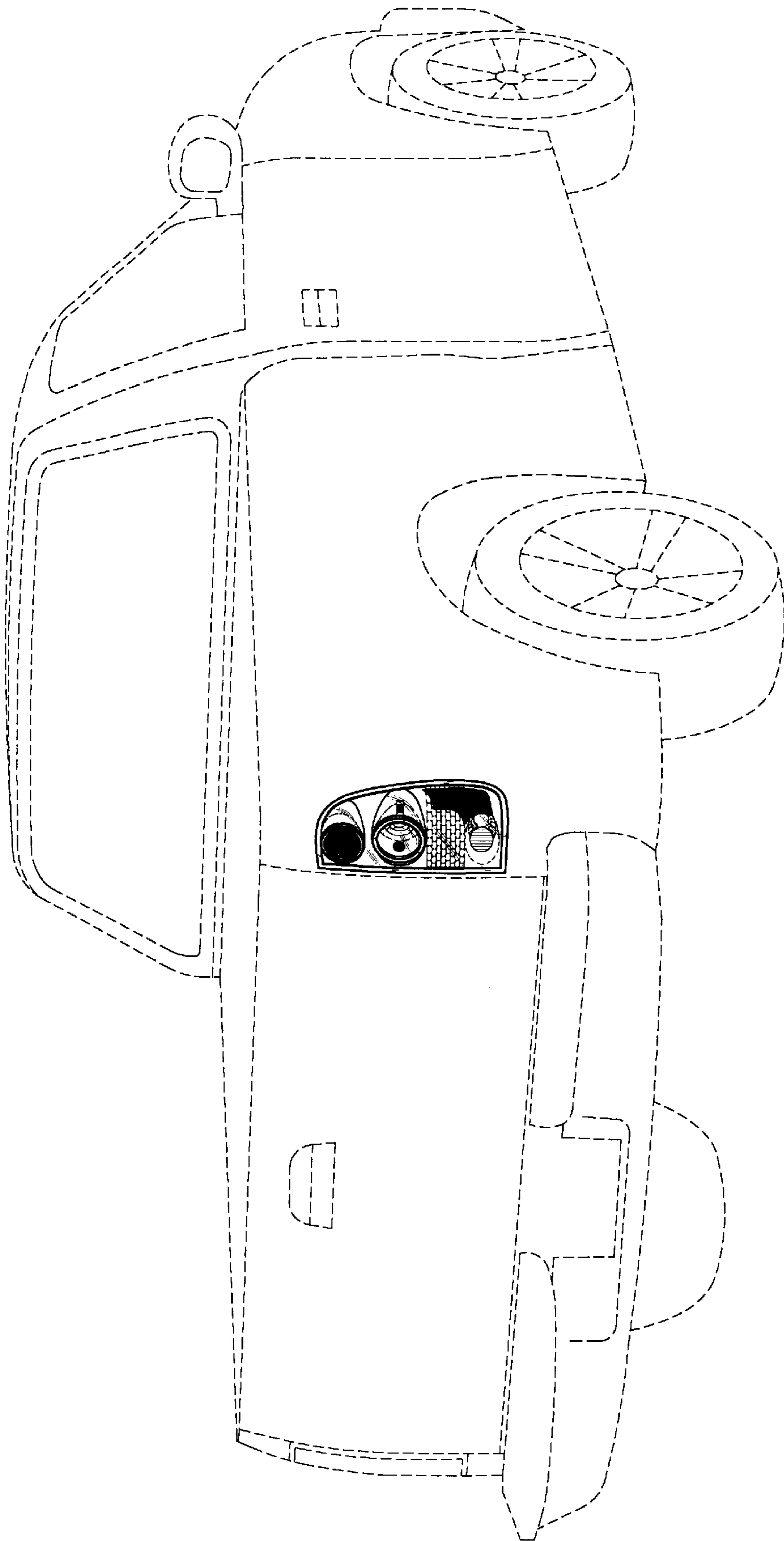

FIG. 12