



US00D483640S

(12) **United States Design Patent**
Jimenez

(10) **Patent No.:** **US D483,640 S**

(45) **Date of Patent:** **** Dec. 16, 2003**

(54) **SAW HANDLE**

(75) Inventor: **Eduardo J. Jimenez**, Manalapan, NJ
(US)

(73) Assignee: **KC Holdings, LLC**

(**) Term: **14 Years**

(21) Appl. No.: **29/174,344**

(22) Filed: **Jan. 17, 2003**

(51) **LOC (7) Cl.** **08-03**

(52) **U.S. Cl.** **D8/97**

(58) **Field of Search** D8/95, 96, 97,
D8/107; 30/505, 506, 507, 511, 513, 515,
517; 81/489

(56) **References Cited**

U.S. PATENT DOCUMENTS

| | | | | | |
|------------|---|---------|-----------------|-------|-------|
| D251,825 S | * | 5/1979 | Breger | | D8/97 |
| D260,072 S | * | 8/1981 | Covey | | D8/97 |
| D269,848 S | * | 7/1983 | Covey | | D8/97 |
| D317,395 S | * | 6/1991 | Landahl | | D8/97 |
| D395,218 S | * | 6/1998 | Martin | | D8/97 |
| D395,588 S | * | 6/1998 | Davis et al. | | D8/97 |
| D405,673 S | * | 2/1999 | Bidstrup et al. | | D8/97 |
| D417,379 S | * | 12/1999 | Bidstrup et al. | | D8/97 |
| D440,856 S | | 4/2001 | Jimenez | | D8/97 |
| D442,458 S | | 5/2001 | Jimenez | | D8/97 |
| D463,966 S | * | 10/2002 | Juhlin | | D8/97 |

* cited by examiner

Primary Examiner—Philip S. Hyder

(74) *Attorney, Agent, or Firm*—Wolff Law Offices, PLLC;
Kevin Alan Wolff

(57) **CLAIM**

The ornamental design for a saw handle, as shown and described.

DESCRIPTION

FIG. 1 is a perspective view of the saw handle showing my new design looking downwardly at a rear and left side thereof, and showing a saw blade in broken lines attached to the saw handle;

FIG. 2 is a perspective view of the saw handle showing my new design looking upward at the front and left side thereof, and showing a saw blade in broken lines attached to the saw handle;

FIG. 3 is a left elevation view of the saw handle and a portion of the attached saw blade in broken lines;

FIG. 4 is a front elevation view of the saw handle and the saw blade in broken lines;

FIG. 5 is a rear elevation view of the saw handle with the saw blade in broken lines;

FIG. 6 is a top plan view of the saw handle and a portion of the saw blade in broken lines; and,

FIG. 7 is a bottom plan view of the saw handle and a portion of the saw blade in broken lines.

The broken lines showing the saw blade and the means for mounting the saw handle to the saw blade are for illustrative purposes only and forms no part of the claimed design. A right side elevation view of the saw blade is a mirror image of the left side elevation view.

1 Claim, 5 Drawing Sheets

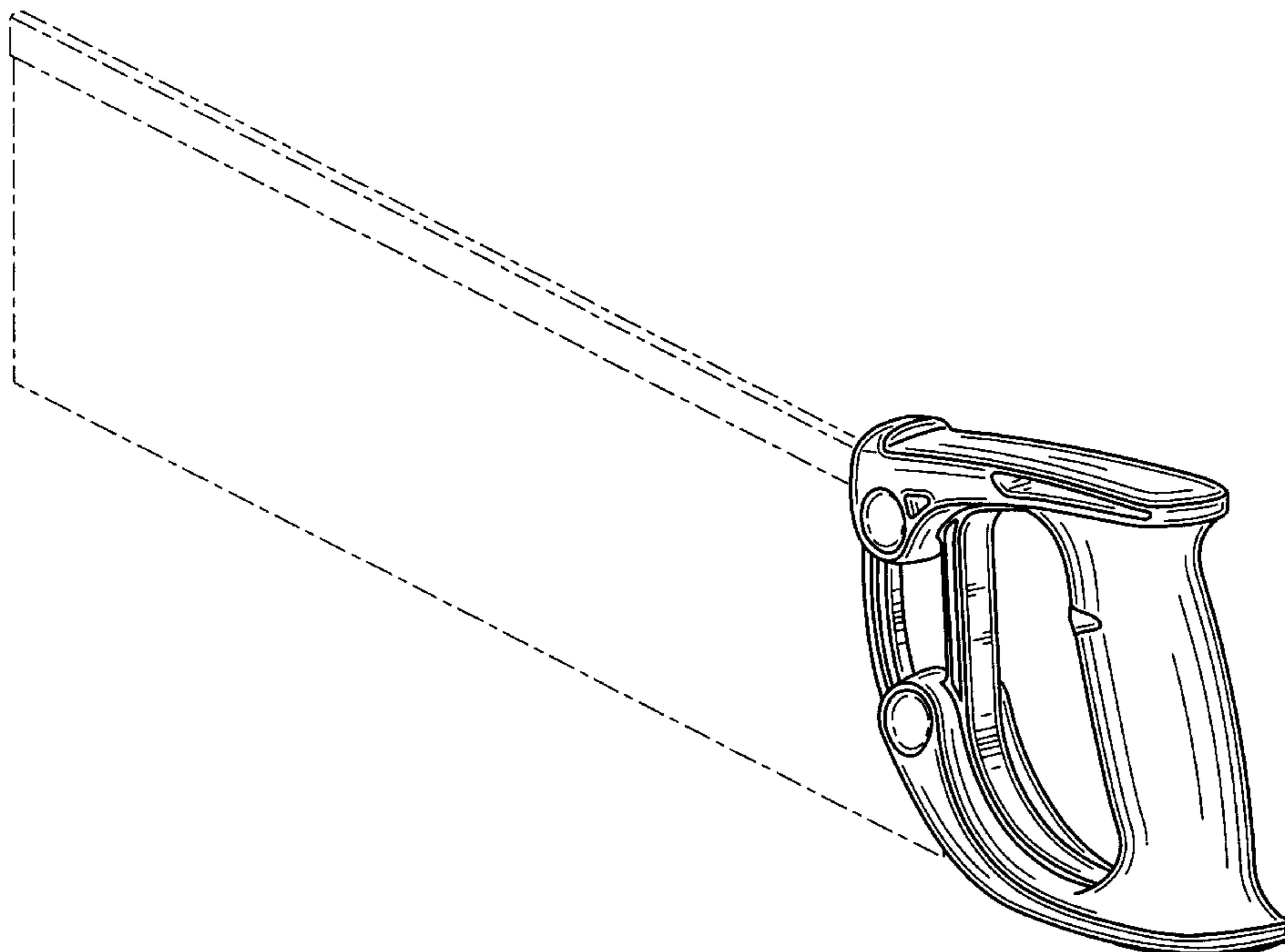

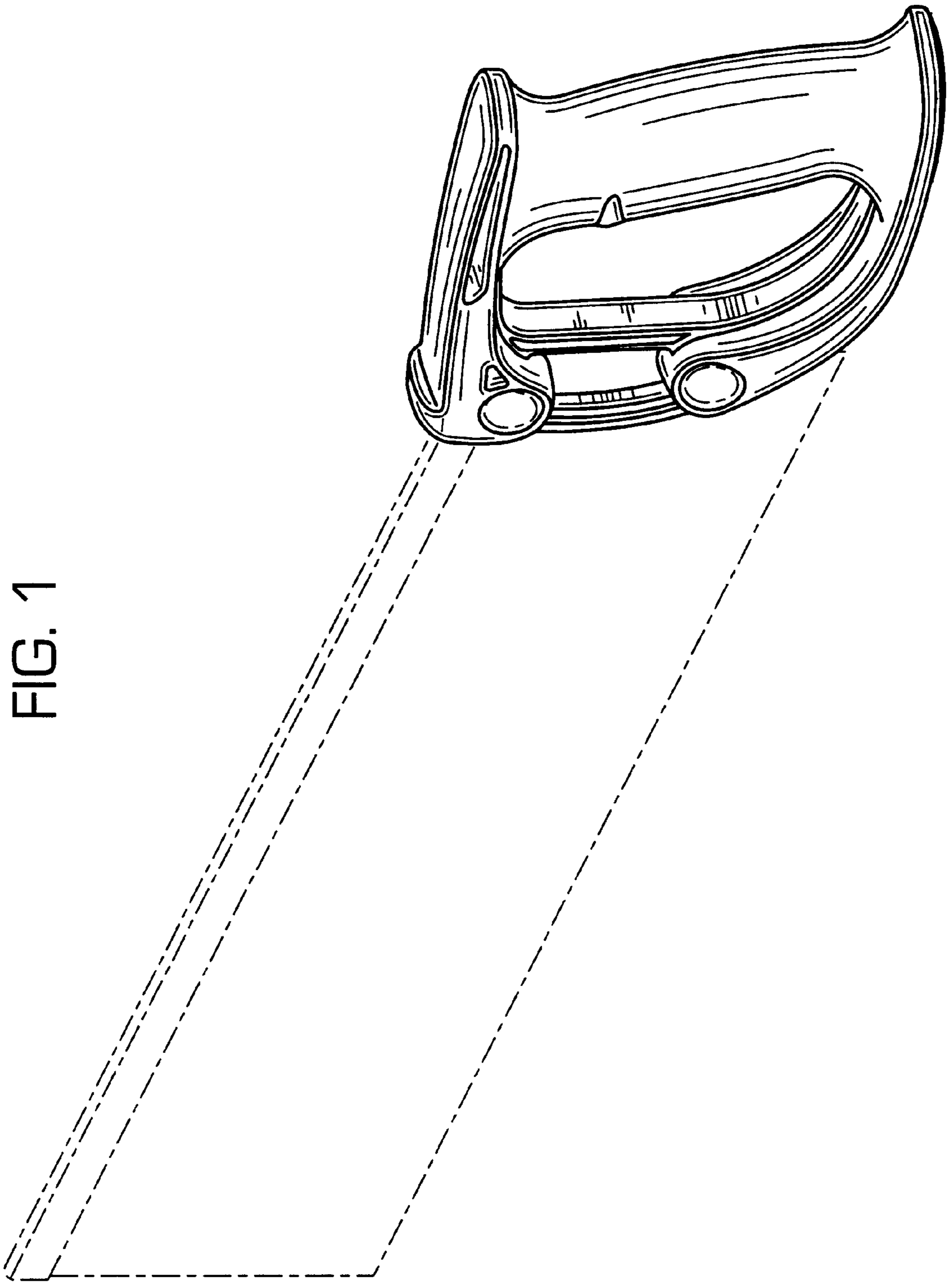

FIG. 1

FIG. 2

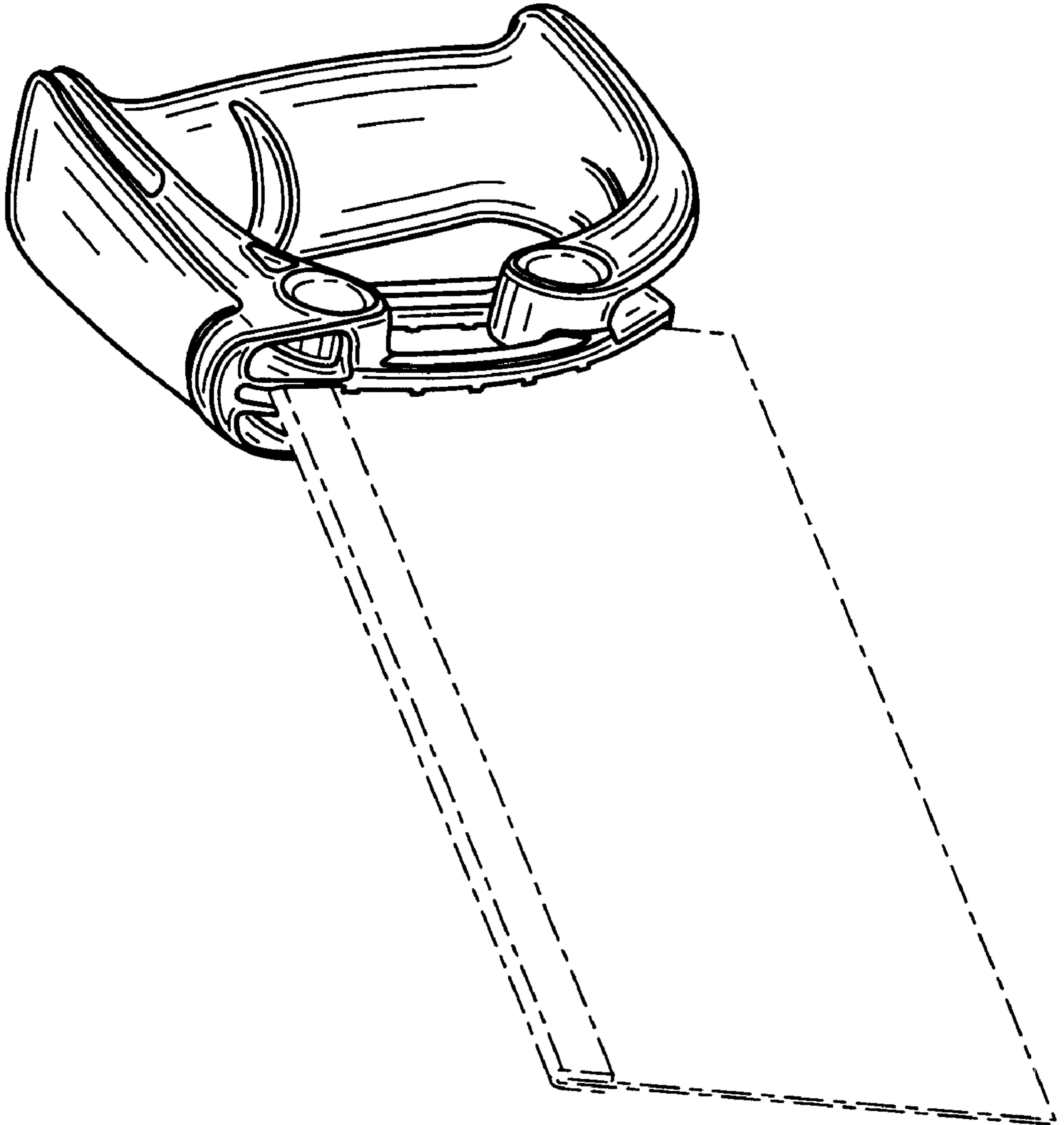

FIG. 3

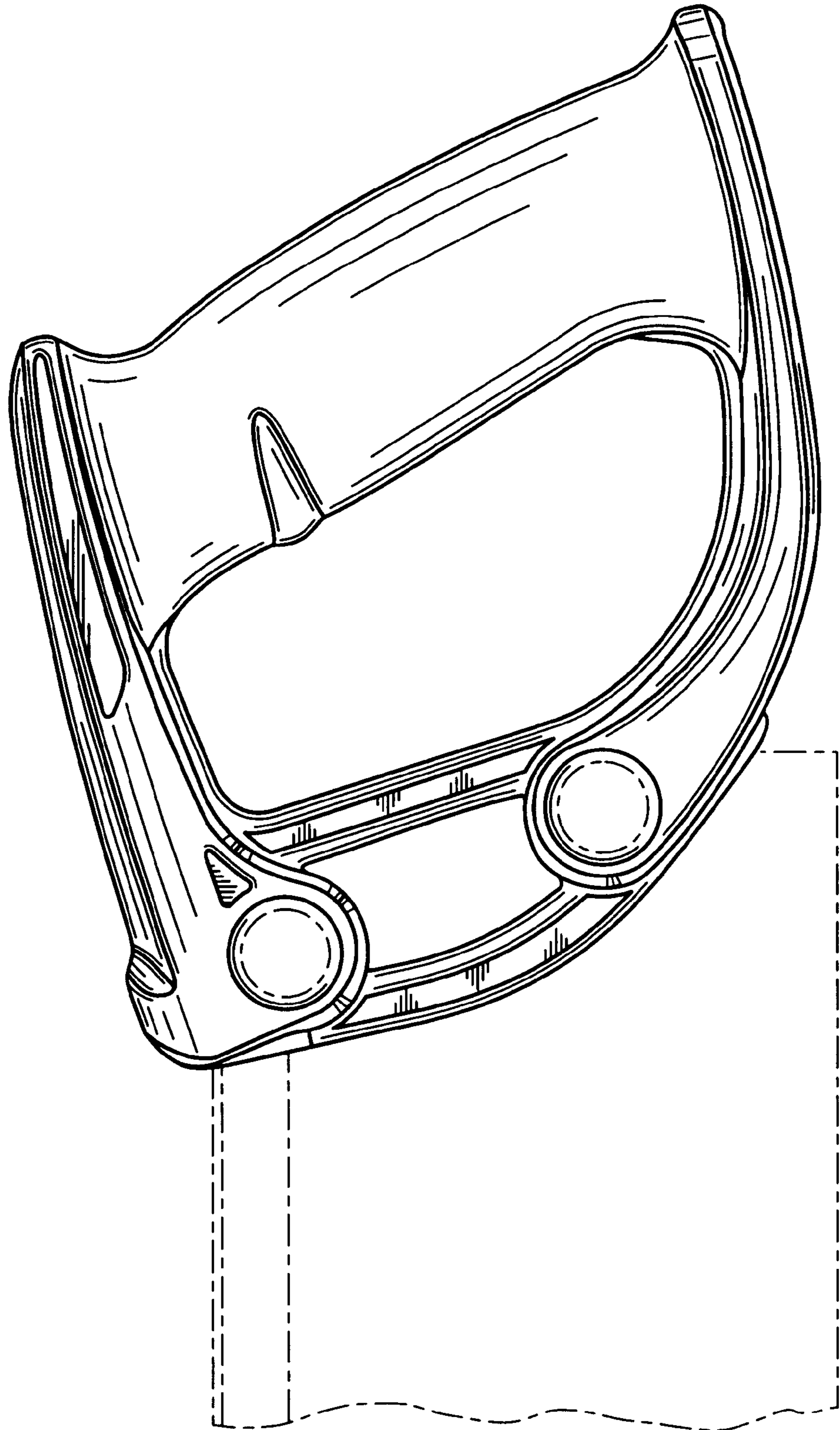

FIG. 4

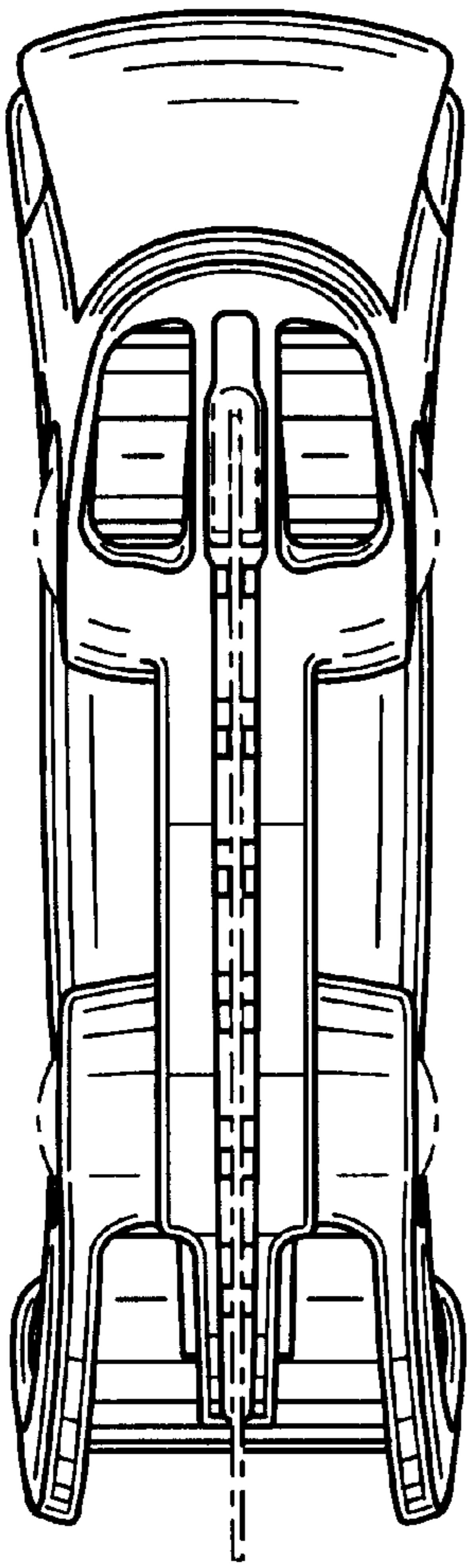

FIG. 5

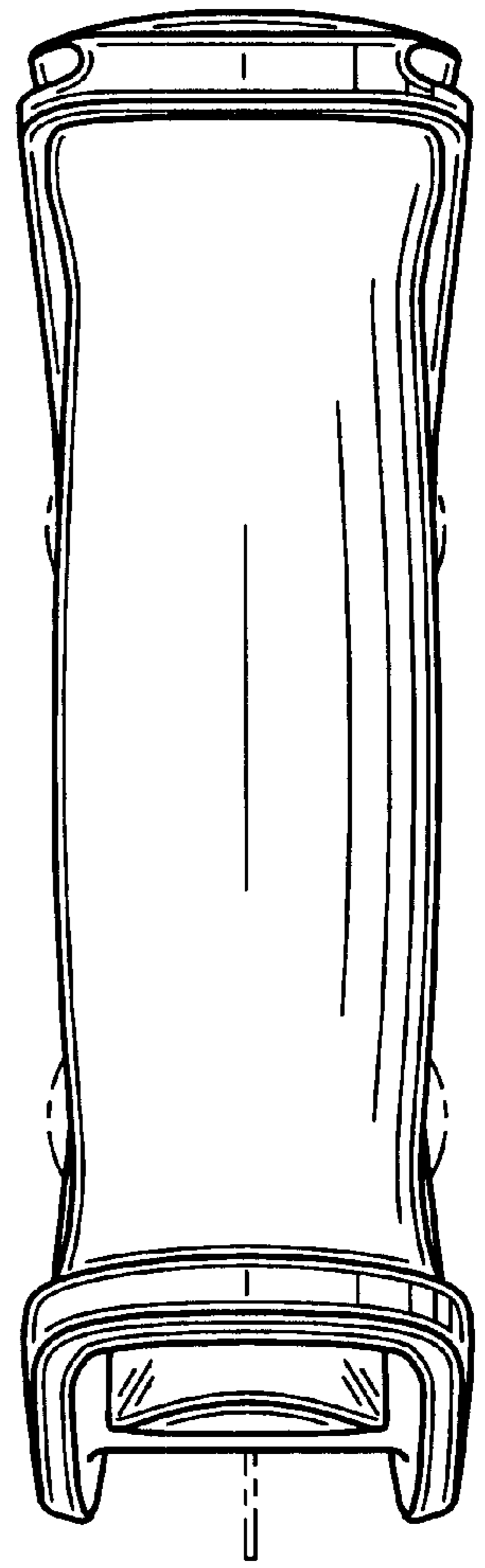

FIG. 6

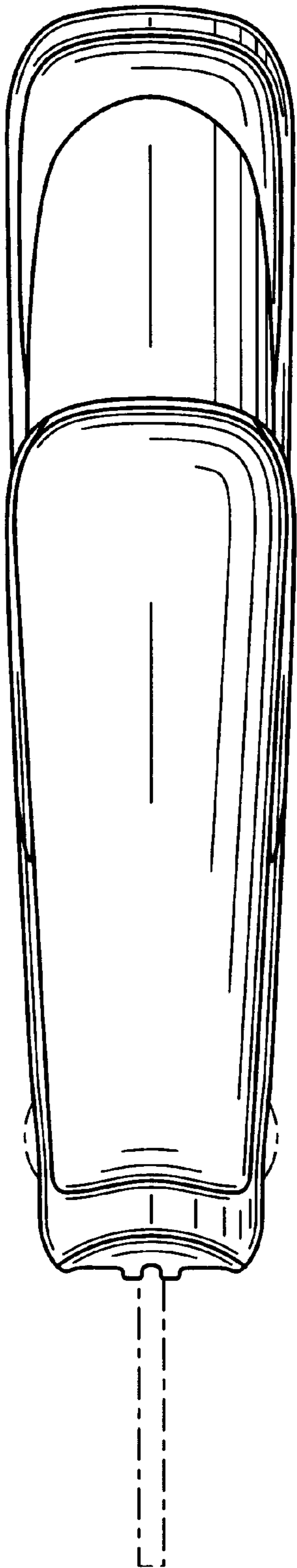

FIG. 7

