



US00D483627S

(12) **United States Design Patent**
Ronan et al.

(10) **Patent No.:** **US D483,627 S**

(45) **Date of Patent:** **** Dec. 16, 2003**

(54) **HANDHELD KITCHEN SCISSORS AND KNIFE COMBINATION APPLIANCE**

D424,392 S * 5/2000 Mock D8/57

* cited by examiner

(76) Inventors: **John S. Ronan**, Ronan Tools, Inc.,
1290 S. Santa Fe Ave., San Jacinto, CA
(US) 92583; **Richard A. Kluender**,
Ronan Tools, Inc., 1290 S. Santa Fe
Ave., San Jacinto, CA (US) 92583

Primary Examiner—Clare E. Heflin

(74) *Attorney, Agent, or Firm*—Loyal McKinley Hanson

(**) Term: **14 Years**

(57) **CLAIM**

I claim the ornamental design for a handheld kitchen scissor and knife combination appliance, as shown.

(21) Appl. No.: **29/172,058**

DESCRIPTION

(22) Filed: **Dec. 5, 2002**

FIG. 1 of the drawings is a perspective view showing the front, top, and one side of a handheld kitchen scissor and knife combination appliance embodying the design of my invention;

(51) **LOC (7) Cl.** **07-06**

(52) **U.S. Cl.** **D7/693; D8/57; D8/55**

FIG. 2 is a left side elevation view;

(58) **Field of Search** **D8/5, 56-58; D7/669,**

D7/693; 30/120, 145, 194, 229, 230, 232,

248, 252-254, 257, 260-262, 298, 279.2;

7/125, 129, 132-135

FIG. 3 is a top plan view;

FIG. 4 is a front elevation view;

FIG. 5 is a right side elevation view;

FIG. 6 is a back elevation view;

FIG. 7 is a bottom plan view; and,

FIG. 8 is a perspective view similar to FIG. 1, but with the handheld kitchen scissor and knife combination appliance in an open configuration.

(56) **References Cited**

U.S. PATENT DOCUMENTS

D273,172 S * 3/1984 Yamagishi D8/57

5,463,814 A * 11/1995 Stowell et al. 30/232

D383,958 S * 9/1997 An et al. D8/57

1 Claim, 3 Drawing Sheets

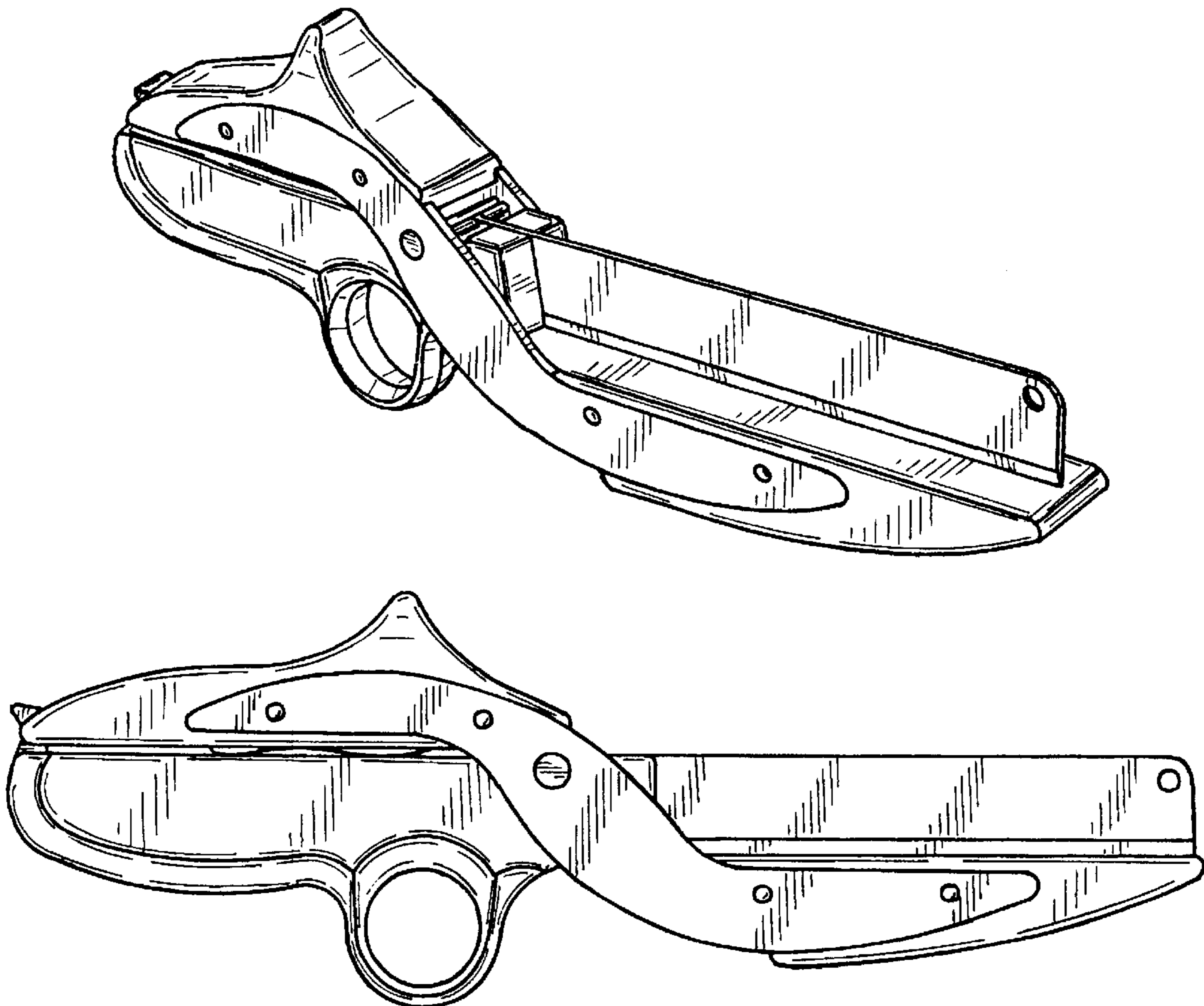

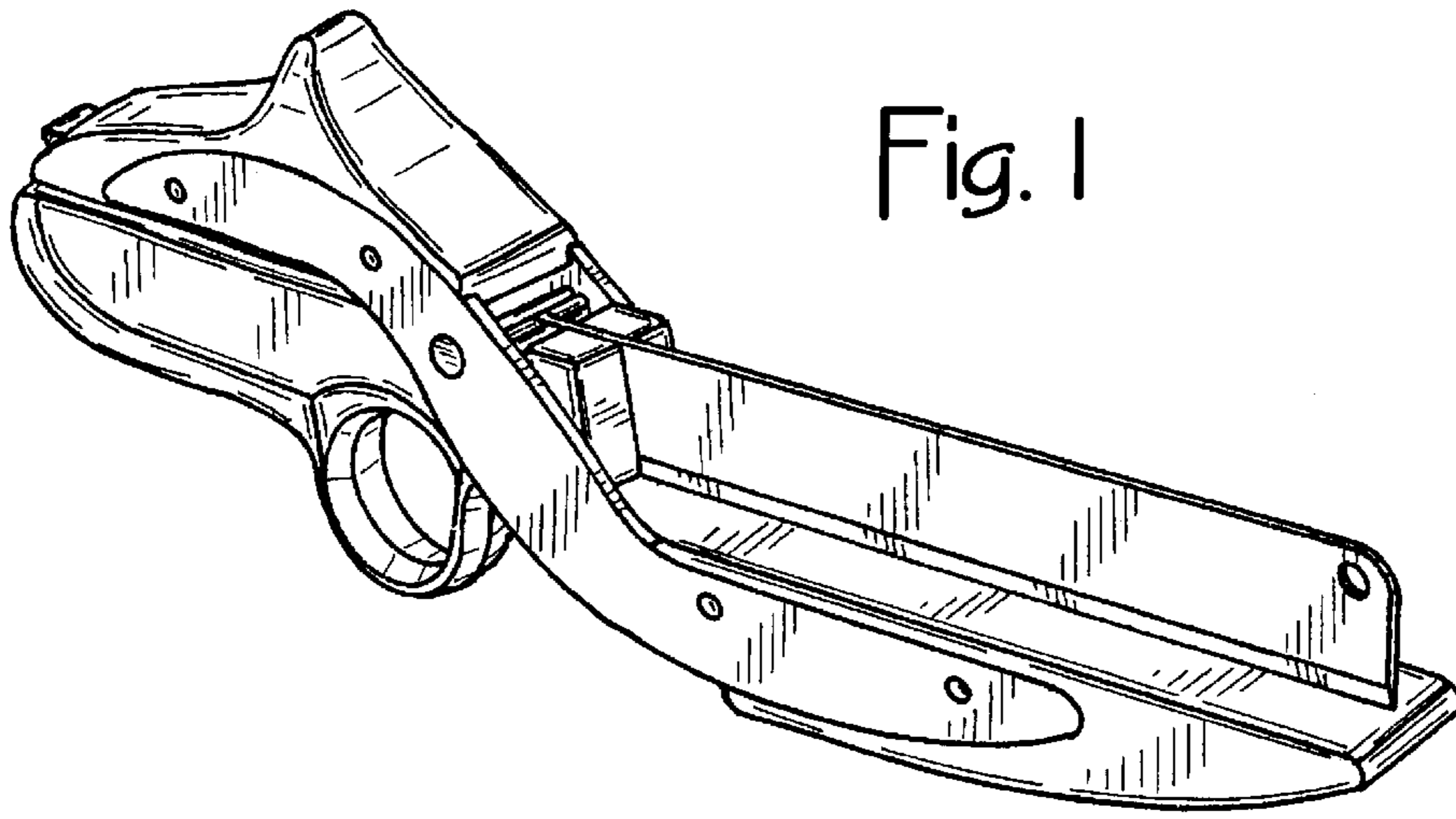

Fig. 1

Fig. 2

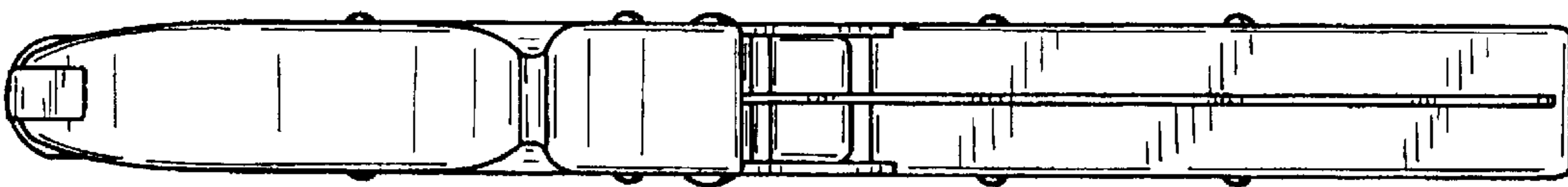
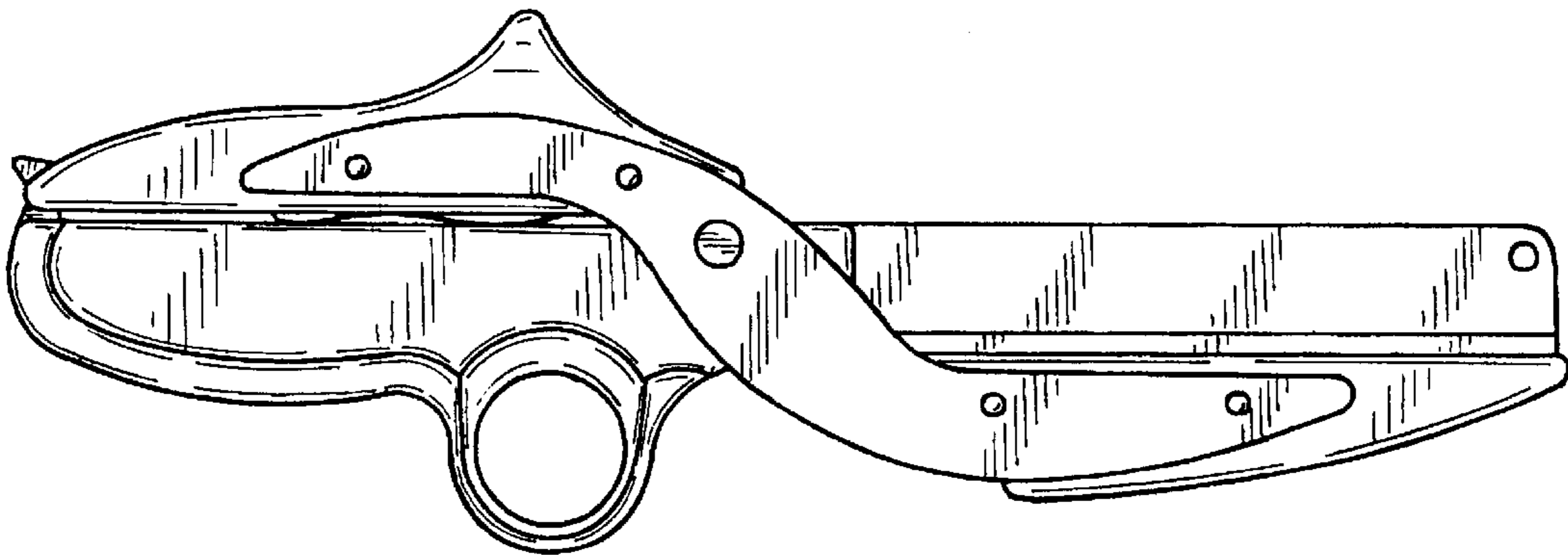

Fig. 3

Fig. 5

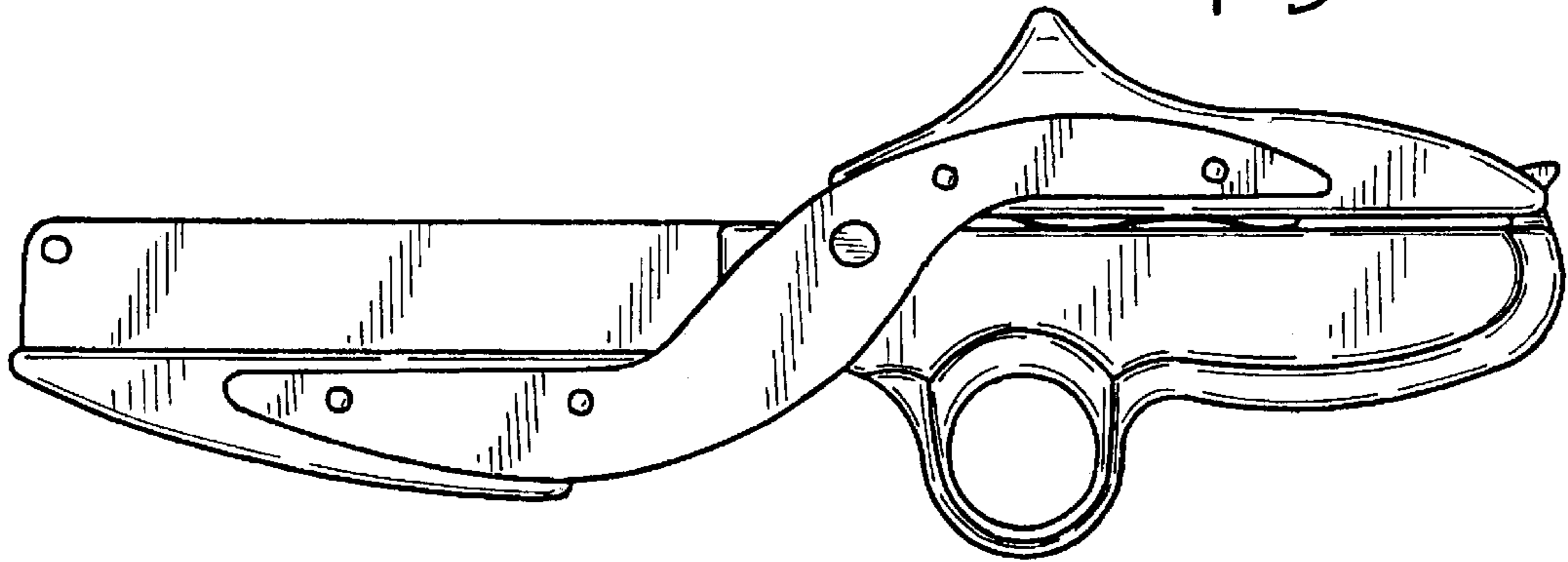

Fig. 4

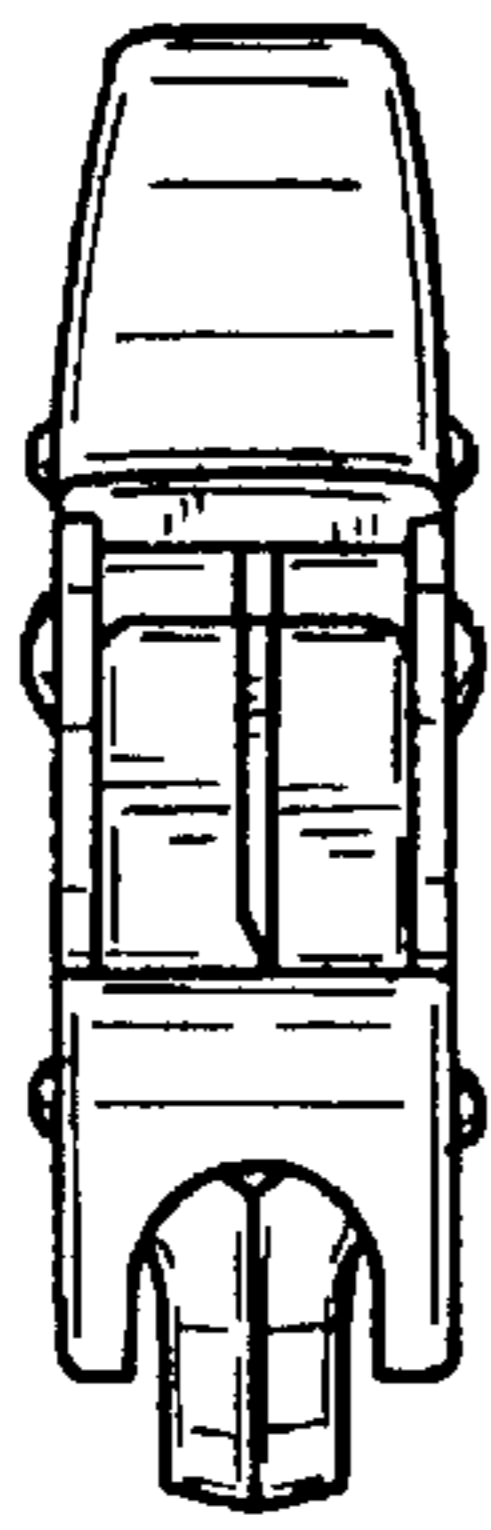

Fig. 6

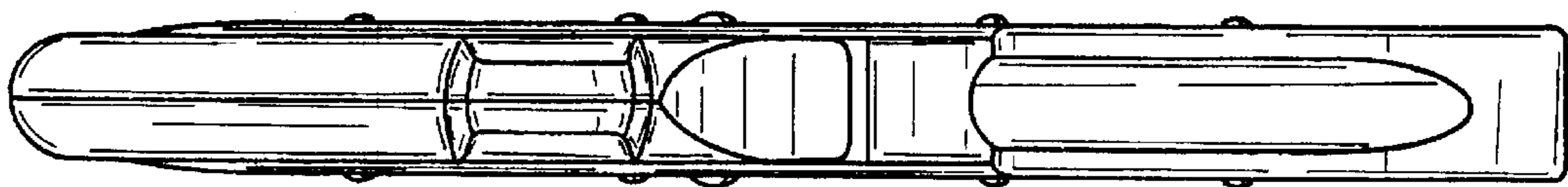
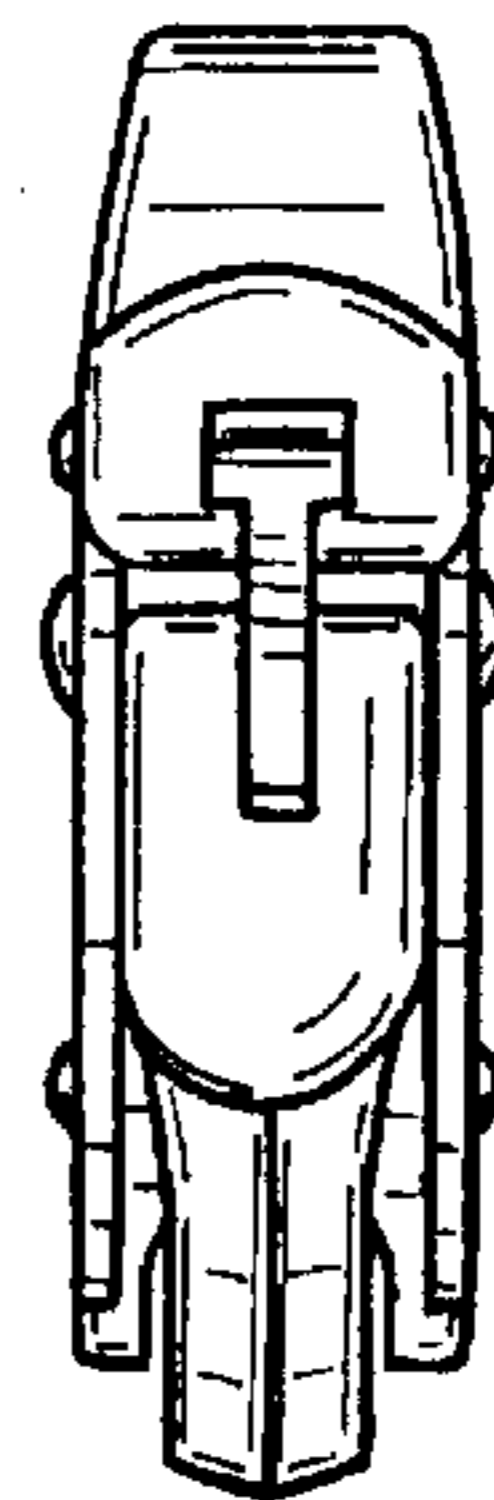

Fig. 7

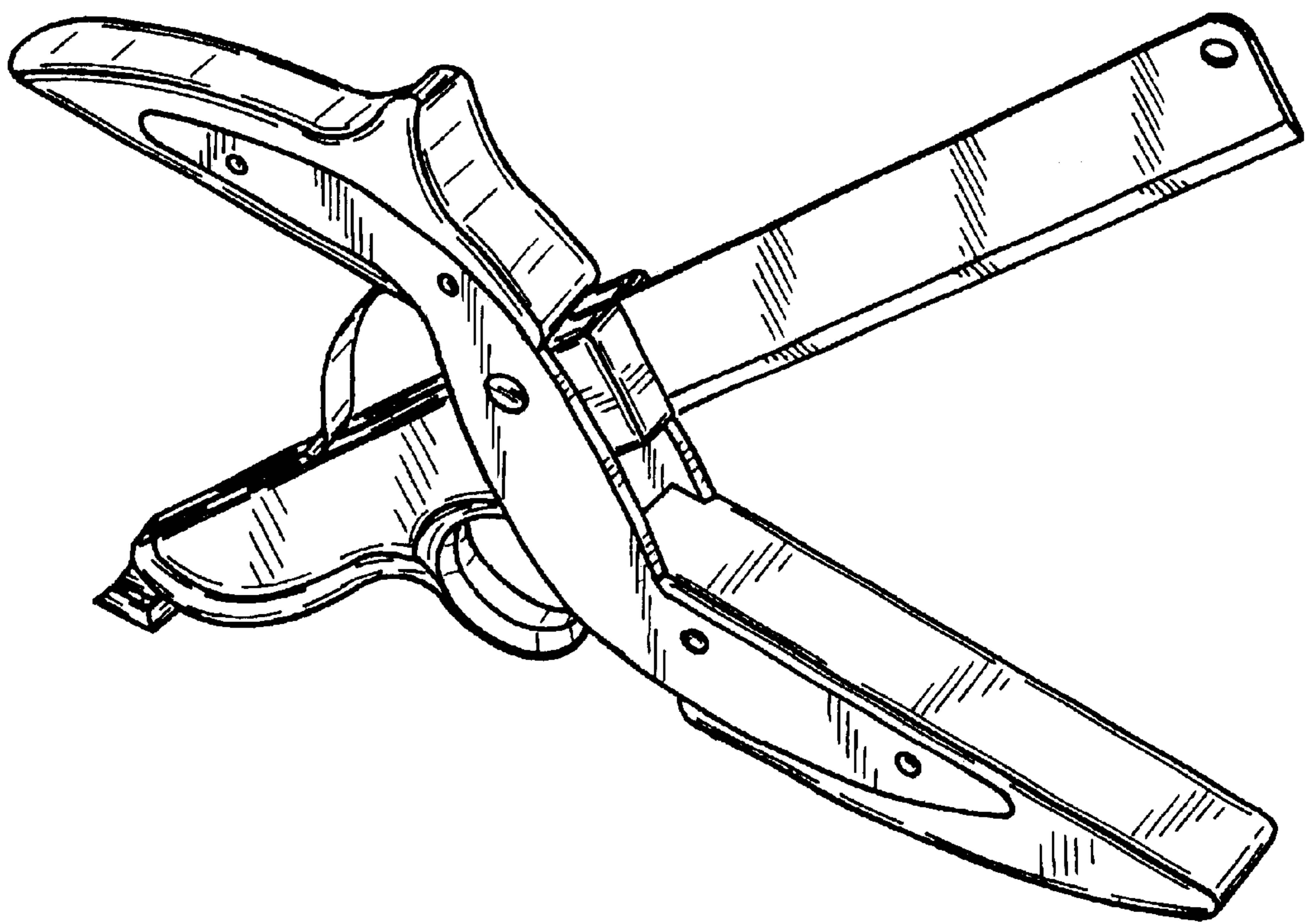

Fig. 8