



US00D483403S

(12) **United States Design Patent**
Hollands et al.

(10) **Patent No.:** **US D483,403 S**

(45) **Date of Patent:** **** Dec. 9, 2003**

(54) **INKBALL WITH A HOLE**

(75) Inventors: **Peter Joseph Hollands**, Baarlo (NL);
Wilhelmus Antonius Maria Schreurs,
Tegelen (NL); **Guido Gerardus**
Willems, Venlo (NL); **Antonius**
Johannes Jozef Van Gerven,
Grubbenvorst (NL); **Reinier Jan**
Ramekers, Oostrum (NL)

(73) Assignee: **Océ-Technologies B.V.**, Venlo (NL)

(**) Term: **14 Years**

(21) Appl. No.: **29/143,690**

(22) Filed: **Jun. 19, 2001**

(30) **Foreign Application Priority Data**

Dec. 19, 2000 (WO) DM/057 757

(51) **LOC (7) Cl.** **18-02**

(52) **U.S. Cl.** **D18/56**; 347/88; 106/31.29

(58) **Field of Search** D18/43, 56, 12;
347/54, 88, 99, 86, 87; 106/31.29, 31.61;
107/31.29, 31.61; 119/706-711; D21/713;
473/596, 603, 604; 40/327

(56) **References Cited**

U.S. PATENT DOCUMENTS

2,115,926 A * 5/1938 Hatton 473/596

2,625,398 A	*	1/1953	Robinson	473/603
3,185,476 A	*	5/1965	Fechner	473/596
3,401,935 A	*	9/1968	Dietz	473/596
D225,876 S	*	1/1973	Massapequa	D21/713
3,924,856 A	*	12/1975	Dekan et al.	473/594
4,714,937 A	*	12/1987	Kaplinsky	347/86
5,270,739 A	*	12/1993	Kitani et al.	347/87
5,988,805 A	*	11/1999	Meinhardt	347/88
6,059,916 A	*	5/2000	Betschon	156/256

* cited by examiner

Primary Examiner—Cathy Anne MacCormac

(74) *Attorney, Agent, or Firm*—Birch, Stewart, Kolasch & Birch, LLP

(57) **CLAIM**

The ornamental design for an inkball with a hole, as shown and described.

DESCRIPTION

FIG. 1 is a top plan view of an inkball with a hole showing our new design;
FIG. 2 is a front right perspective view thereof;
FIG. 3 is a bottom plan view thereof;
FIG. 4 is a right side view thereof, the left side, front and rear views being identical thereof;
FIG. 5 is a sectional view thereof, taken along line 5—5 of FIG. 1; and,
FIG. 6 is a sectional view thereof, taken along line 6—6 of FIG. 1.

1 Claim, 1 Drawing Sheet

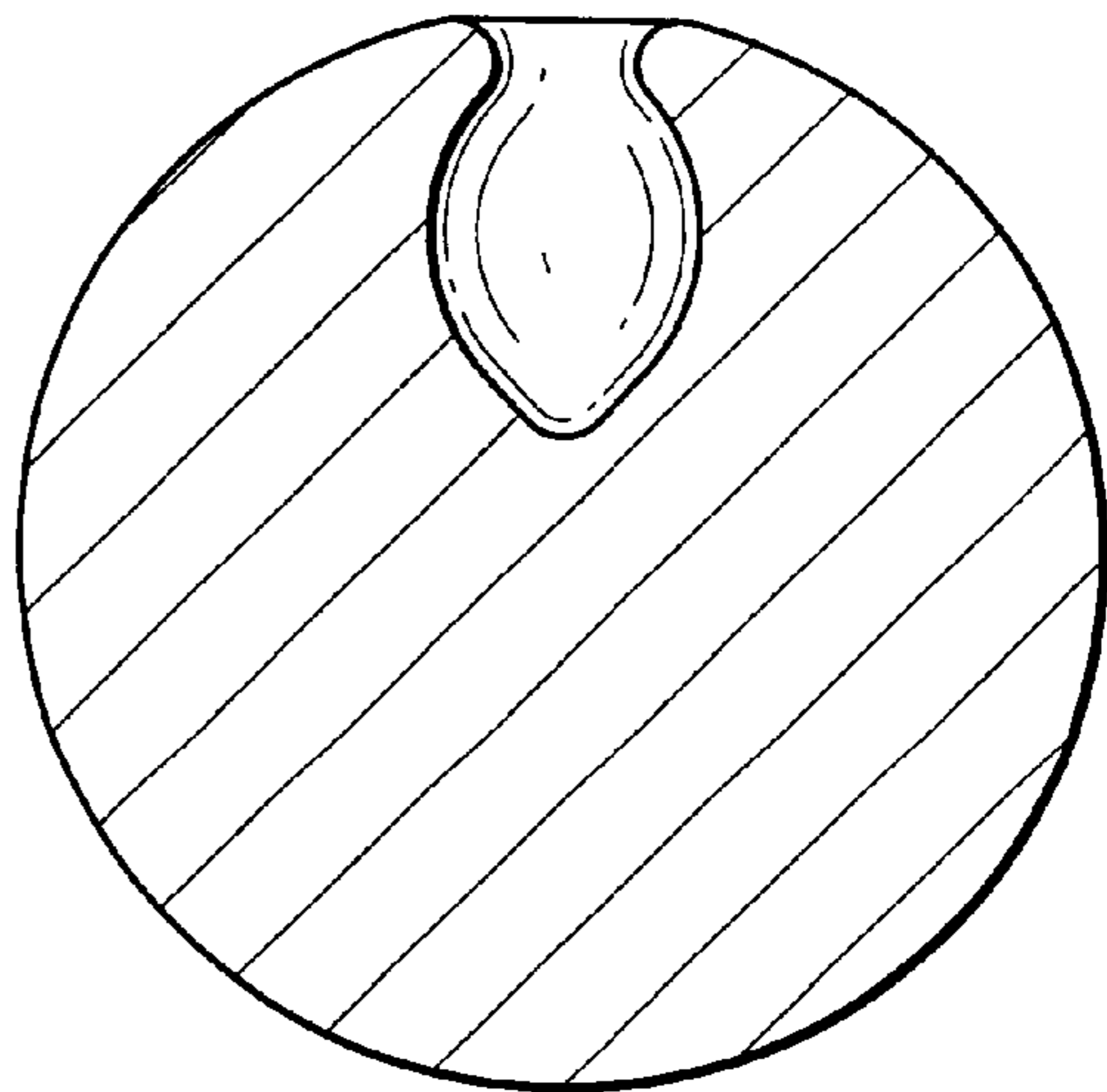
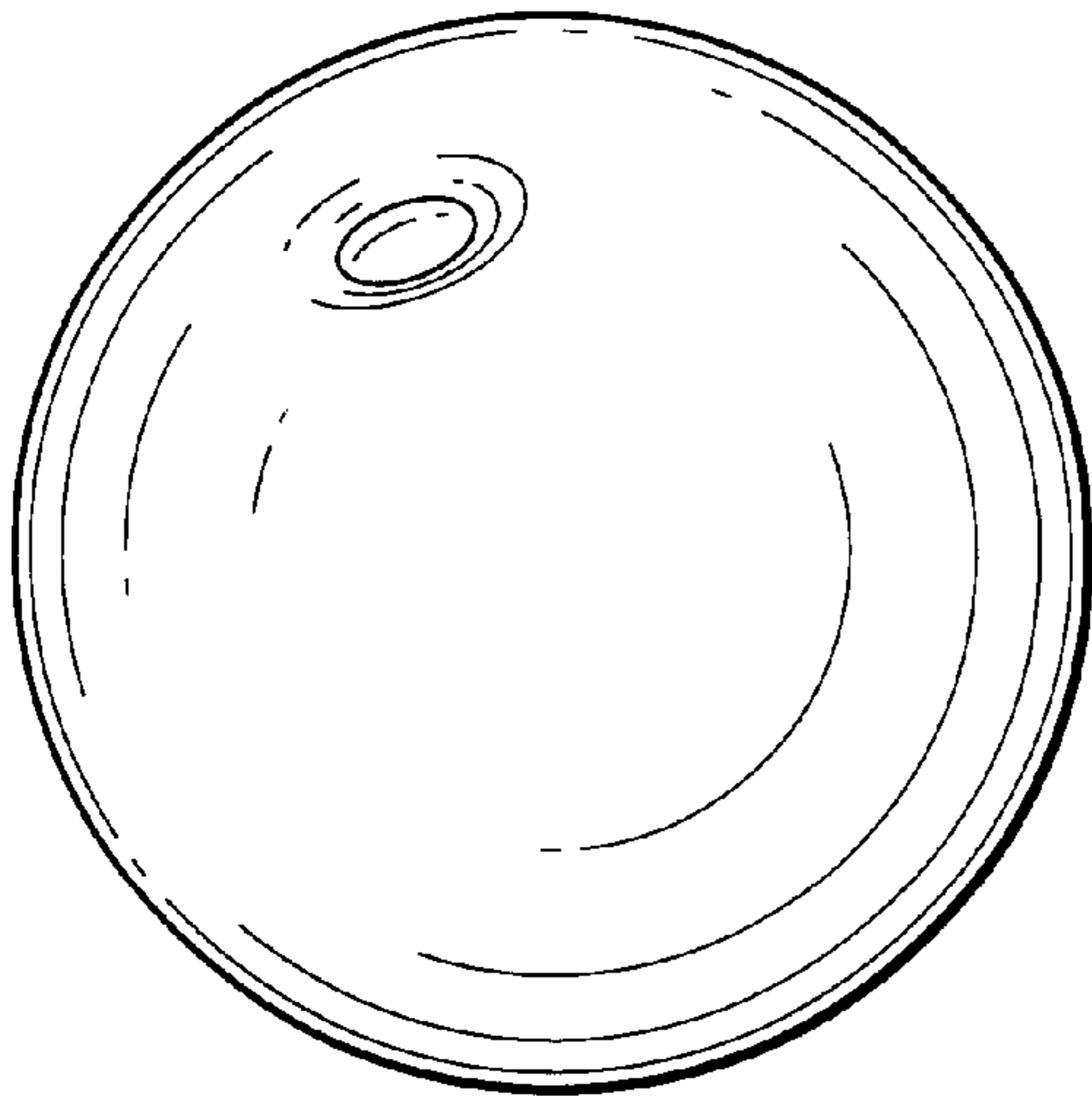

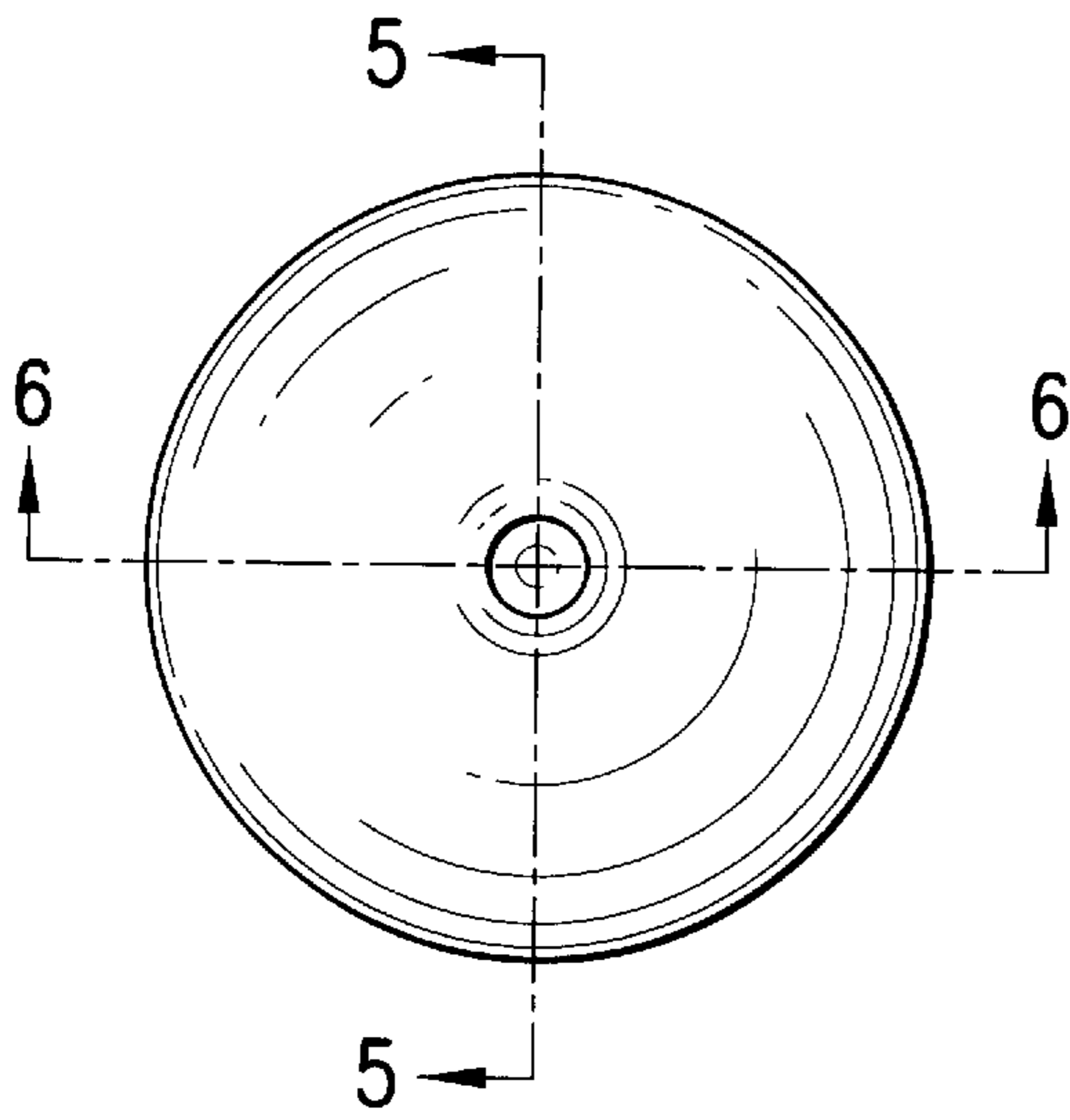

FIG. 1

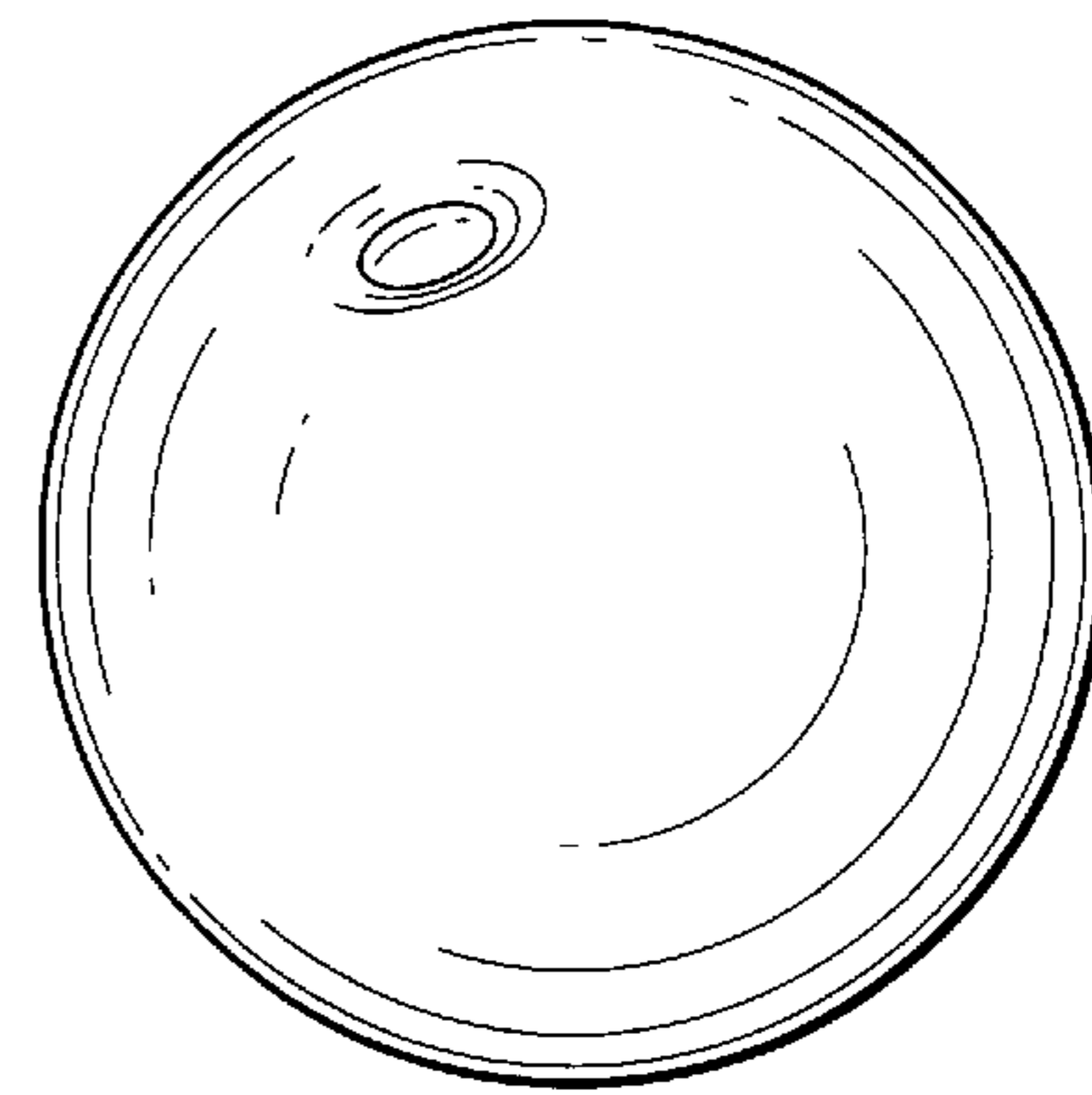

FIG. 2

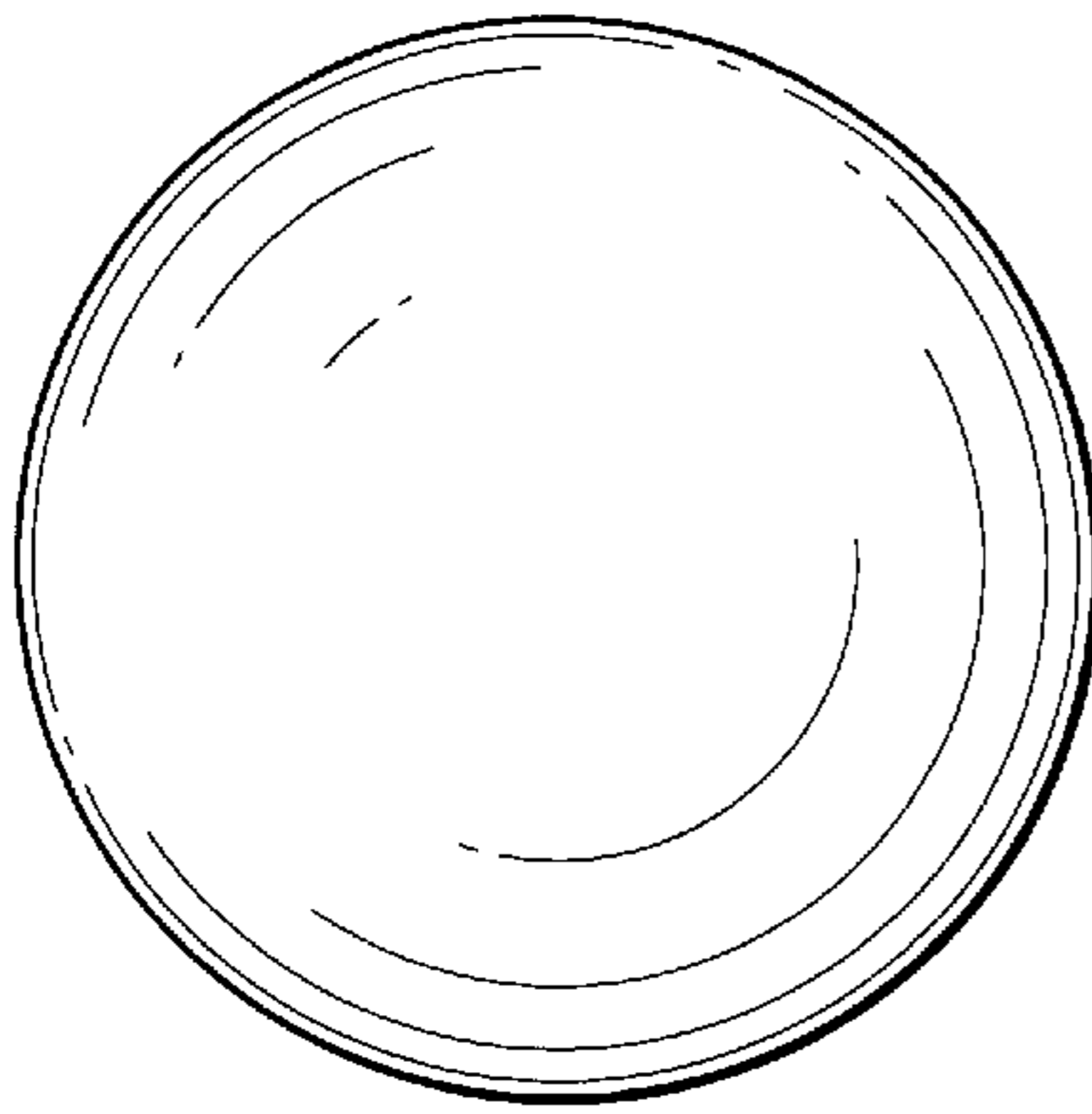

FIG. 3

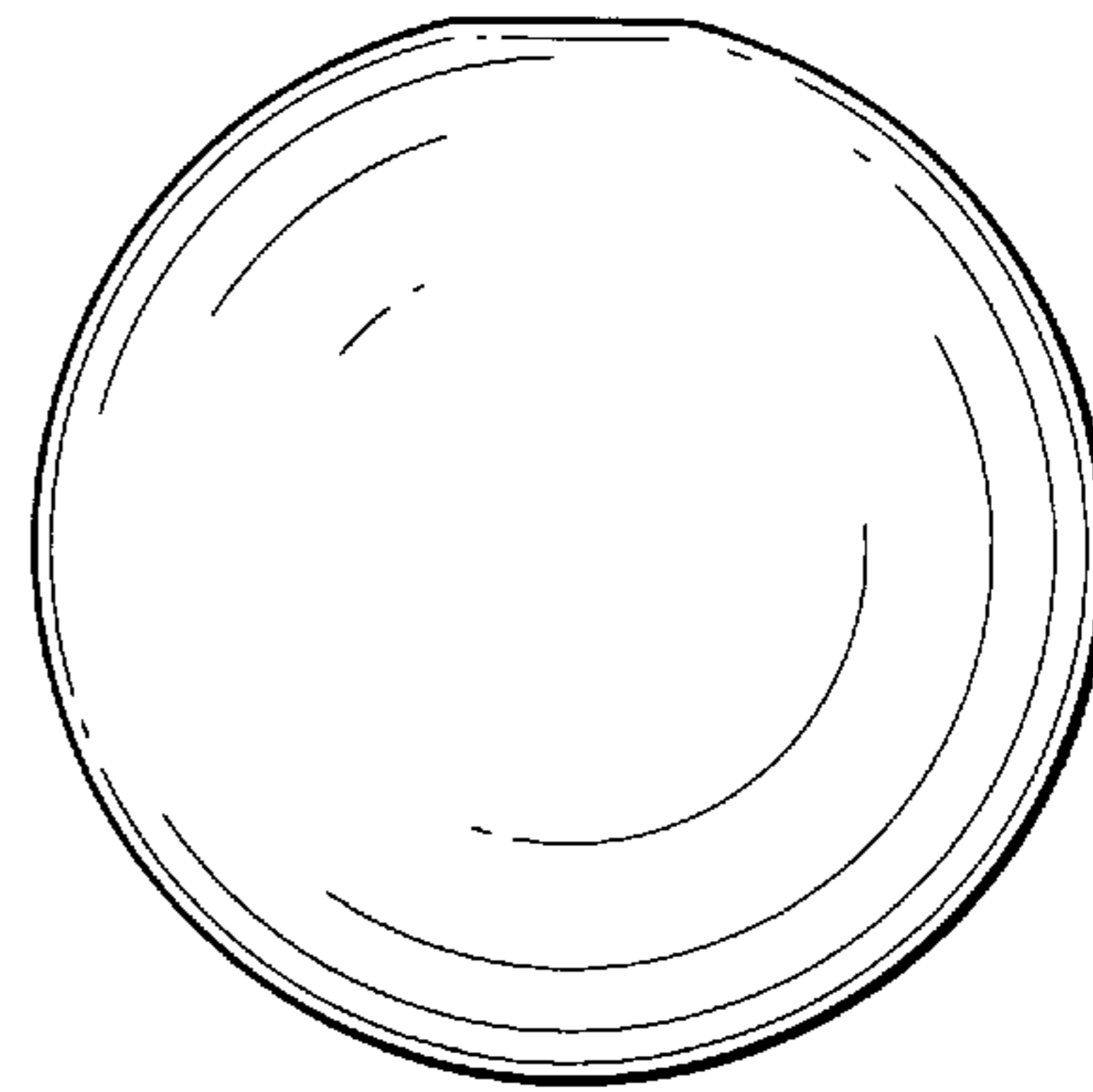

FIG. 4

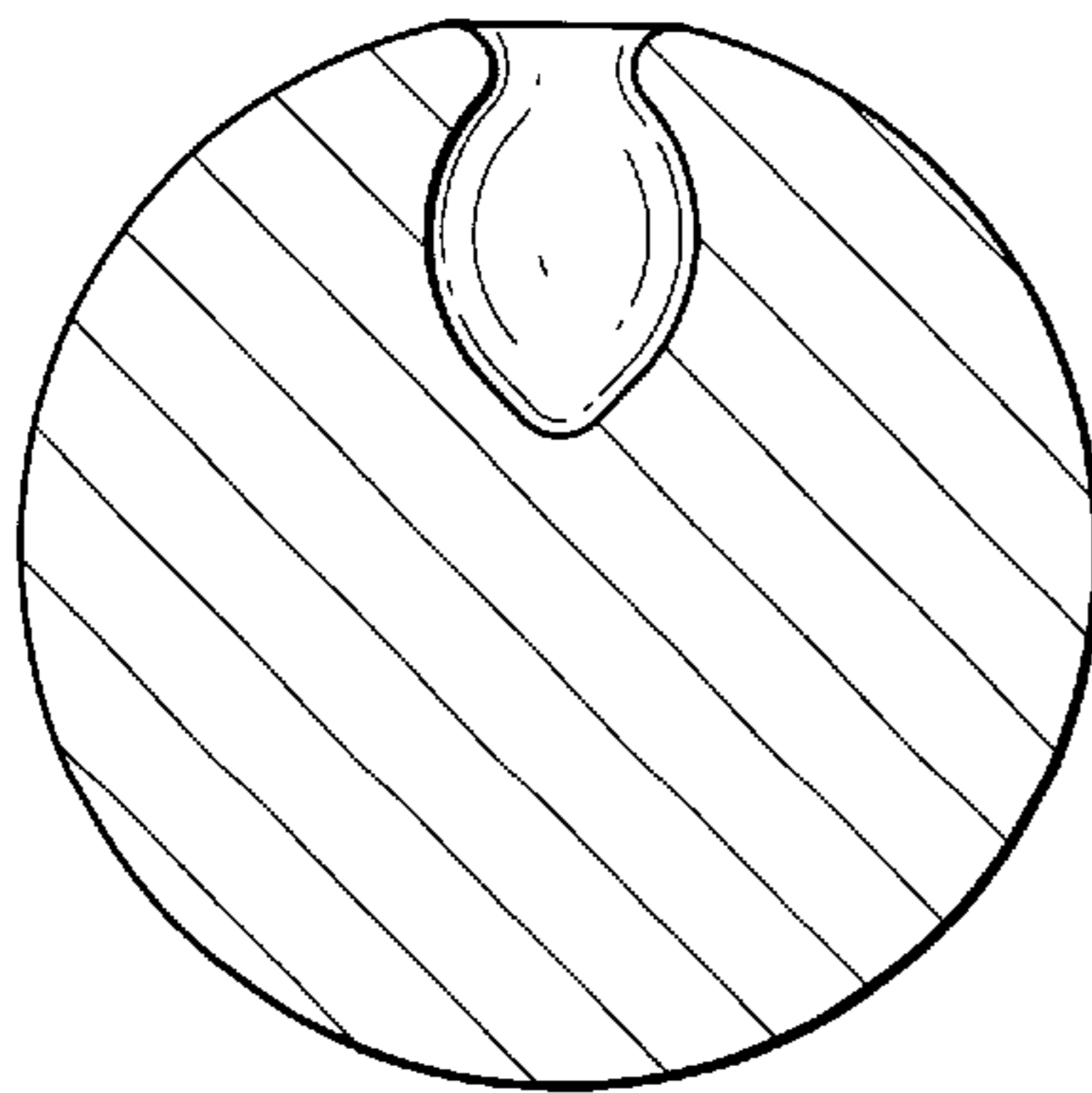

FIG. 5

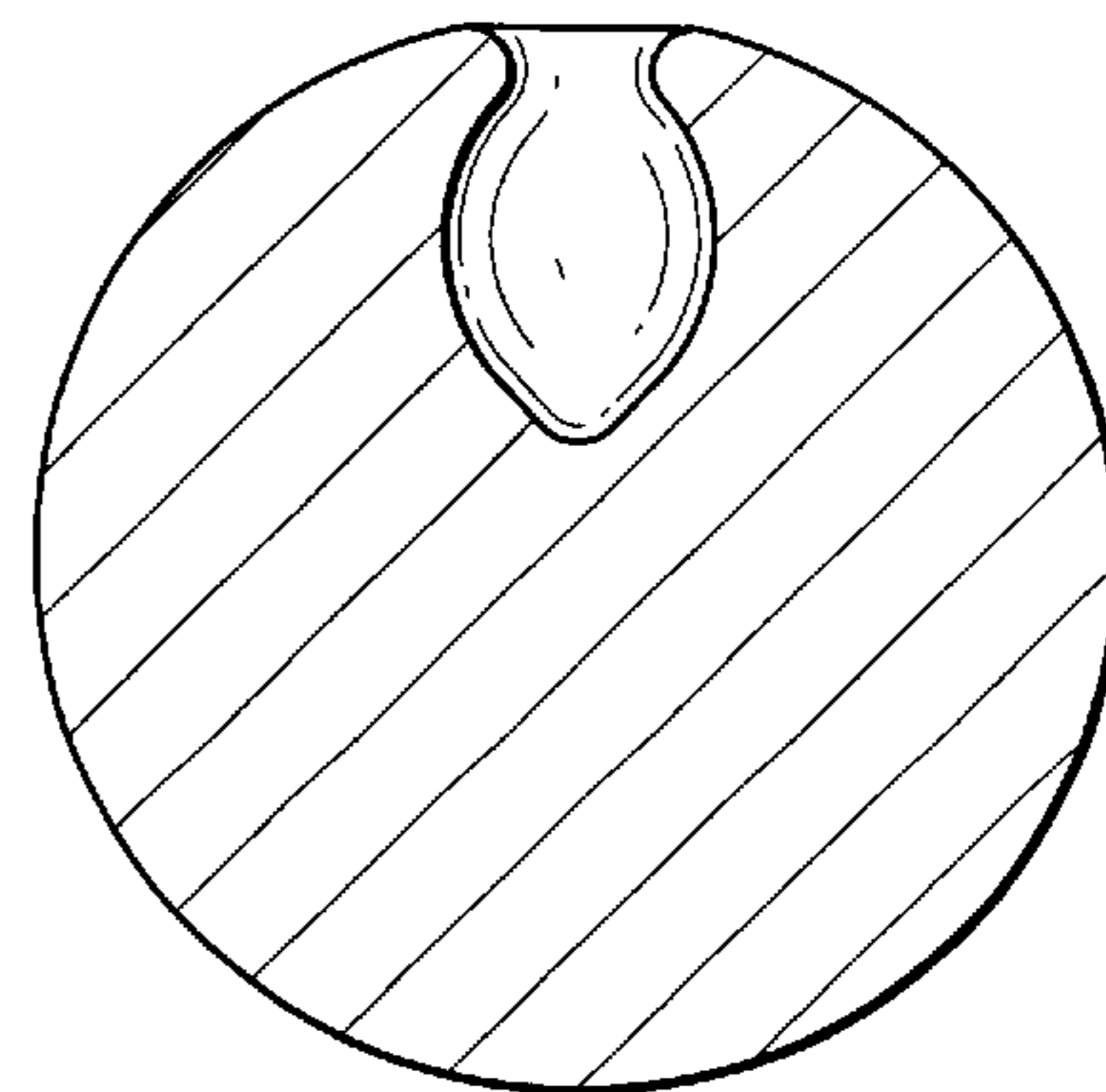

FIG. 6