



US00D483349S

(12) **United States Design Patent**  
**Murakami**

(10) **Patent No.:** **US D483,349 S**

(45) **Date of Patent:** **\*\* Dec. 9, 2003**

(54) **SPEAKER BOX**

(75) Inventor: **Tomonari Murakami**, Tokyo (JP)

(73) Assignee: **Sony Corporation**, Tokyo (JP)

(\*\*) Term: **14 Years**

(21) Appl. No.: **29/169,911**

(22) Filed: **Oct. 29, 2002**

(51) **LOC (7) Cl.** ..... **14-01**

(52) **U.S. Cl.** ..... **D14/215**

(58) **Field of Search** ..... D14/156, 167-168,  
D14/172, 188, 193-198, 204, 207, 209-216,  
356; 181/143-145, 147-148, 150, 153,  
157, 198-199; 369/75.1-75.2, 77.1-77.2;  
381/300-302, 306, 333, 345, 361-364,  
386-388

(56) **References Cited**

**U.S. PATENT DOCUMENTS**

4,582,162	A	*	4/1986	Katsuno	.....	181/150
4,942,939	A	*	7/1990	Harrison	.....	181/150
D359,285	S	*	6/1995	Niblett	.....	D14/170
D384,350	S	*	9/1997	Nuevo et al.	.....	D14/168
D440,556	S		4/2001	Kobayashi et al.		
D442,574	S	*	5/2001	Ishii	.....	D14/168
D442,943	S	*	5/2001	Chang	.....	D14/215

**OTHER PUBLICATIONS**

Web page "Yodobashi.com:LCR60S3 B" wysiwyg://18/http://www.yodobashi.com/shopping/i.jsp?oid=32907, 1 sheet, Yodobashi Camera (Jul. 2002).

Web page "Sony Drive" wysiwyg://31/http://www.sony.jp/products/Models/Library/SRS-T55\_JE.html, 1 sheet, Sony Marketing (Japan) Inc. (Jul. 2002).

\* cited by examiner

*Primary Examiner*—Nanda Bondade

(74) *Attorney, Agent, or Firm*—Rader, Fishman & Grauer PLLC

(57) **CLAIM**

The ornamental design for a speaker box, as shown.

**DESCRIPTION**

FIG. 1 is a perspective view of a speaker box showing my new design;

FIG. 2 is a front elevational view thereof;

FIG. 3 is a rear elevational view thereof;

FIG. 4 is a left side elevational view thereof;

FIG. 5 is a right side elevational view thereof;

FIG. 6 is a top plan view thereof; and,

FIG. 7 is a bottom plan view thereof.

**1 Claim, 4 Drawing Sheets**

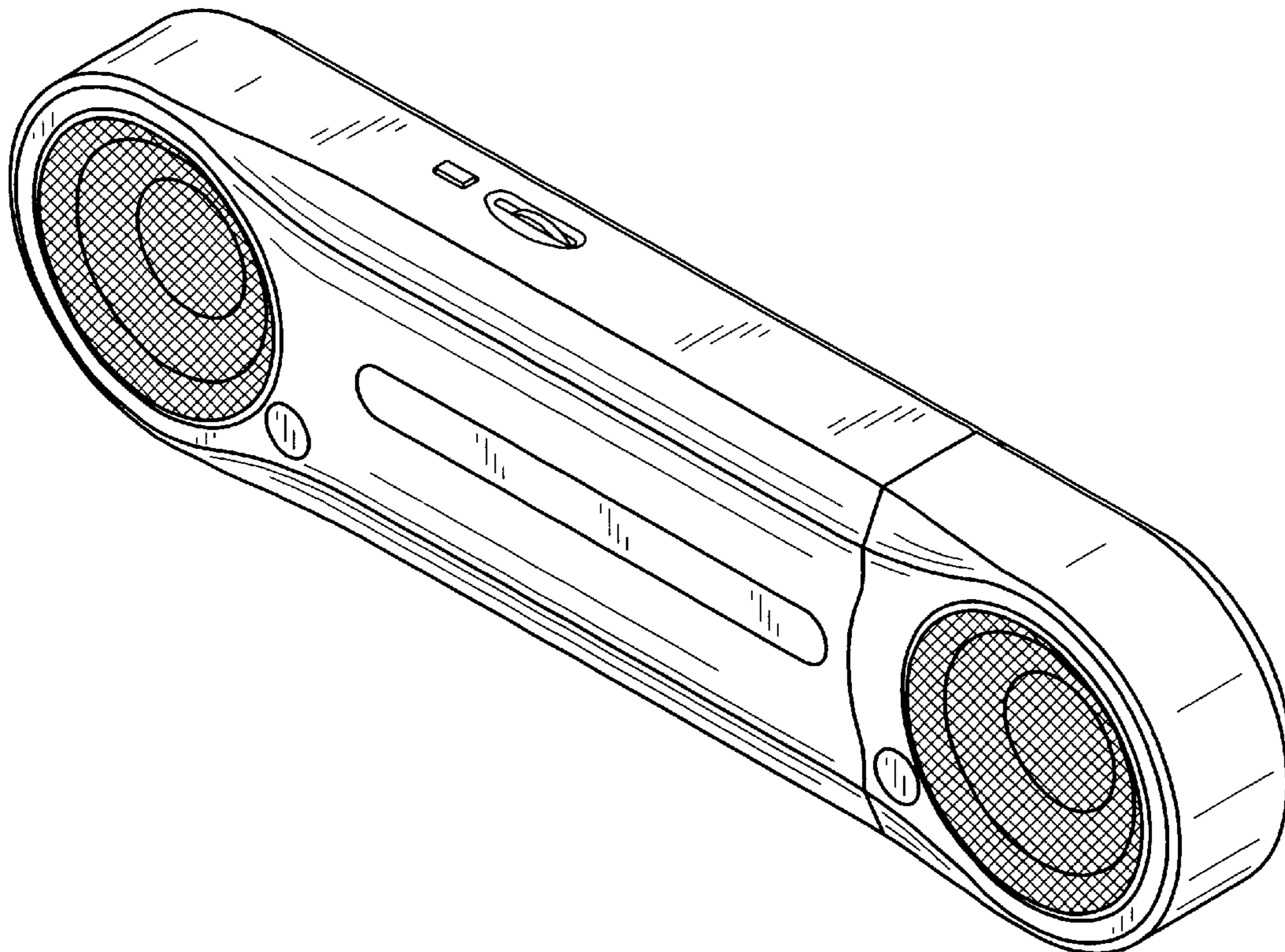

FIG. 1

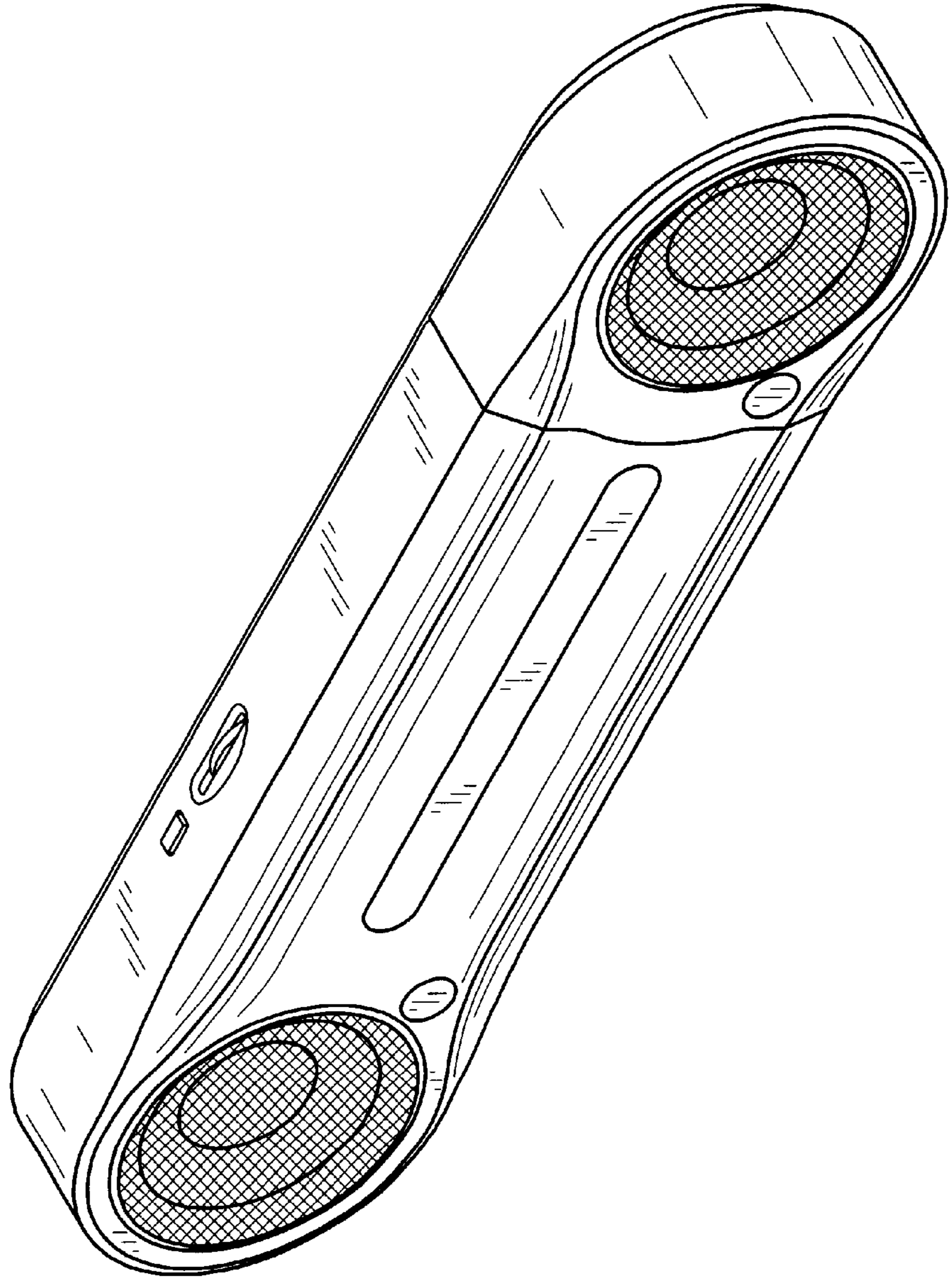

FIG. 2

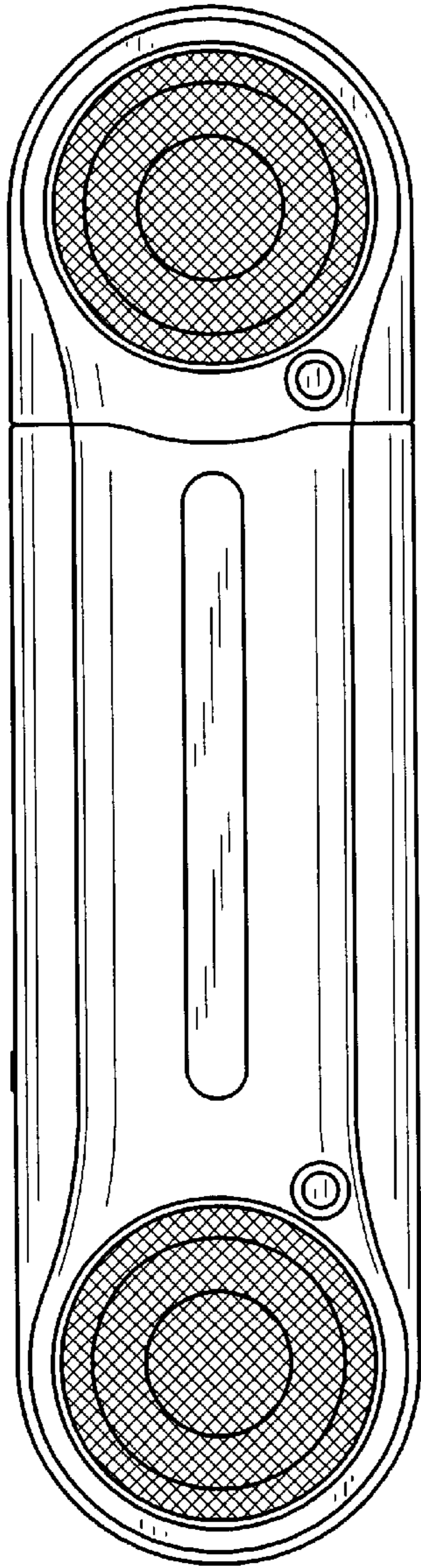

FIG. 3

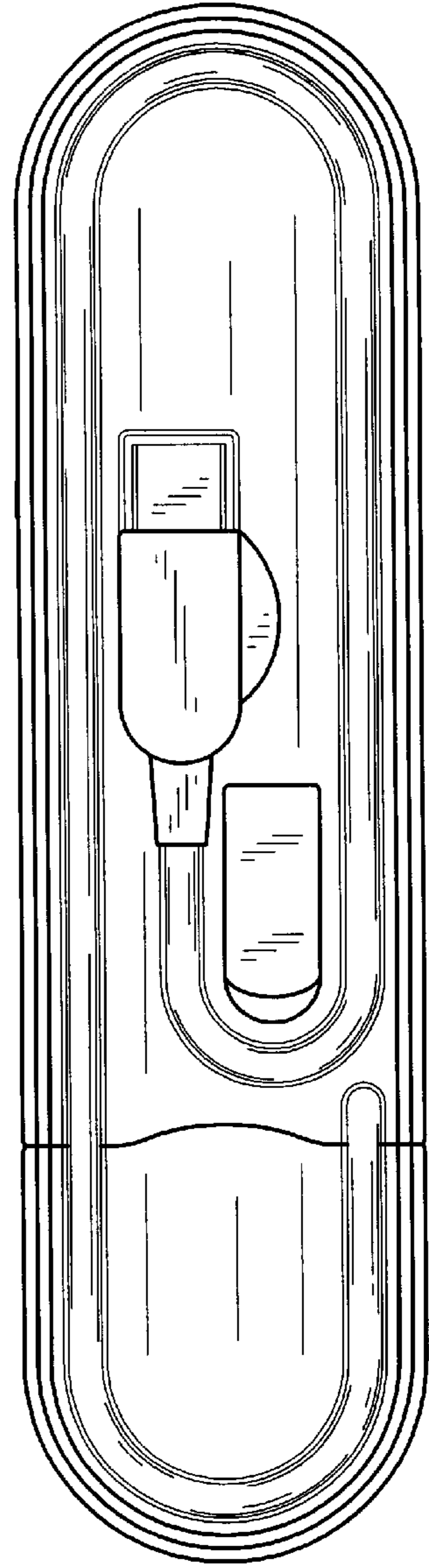

FIG. 4

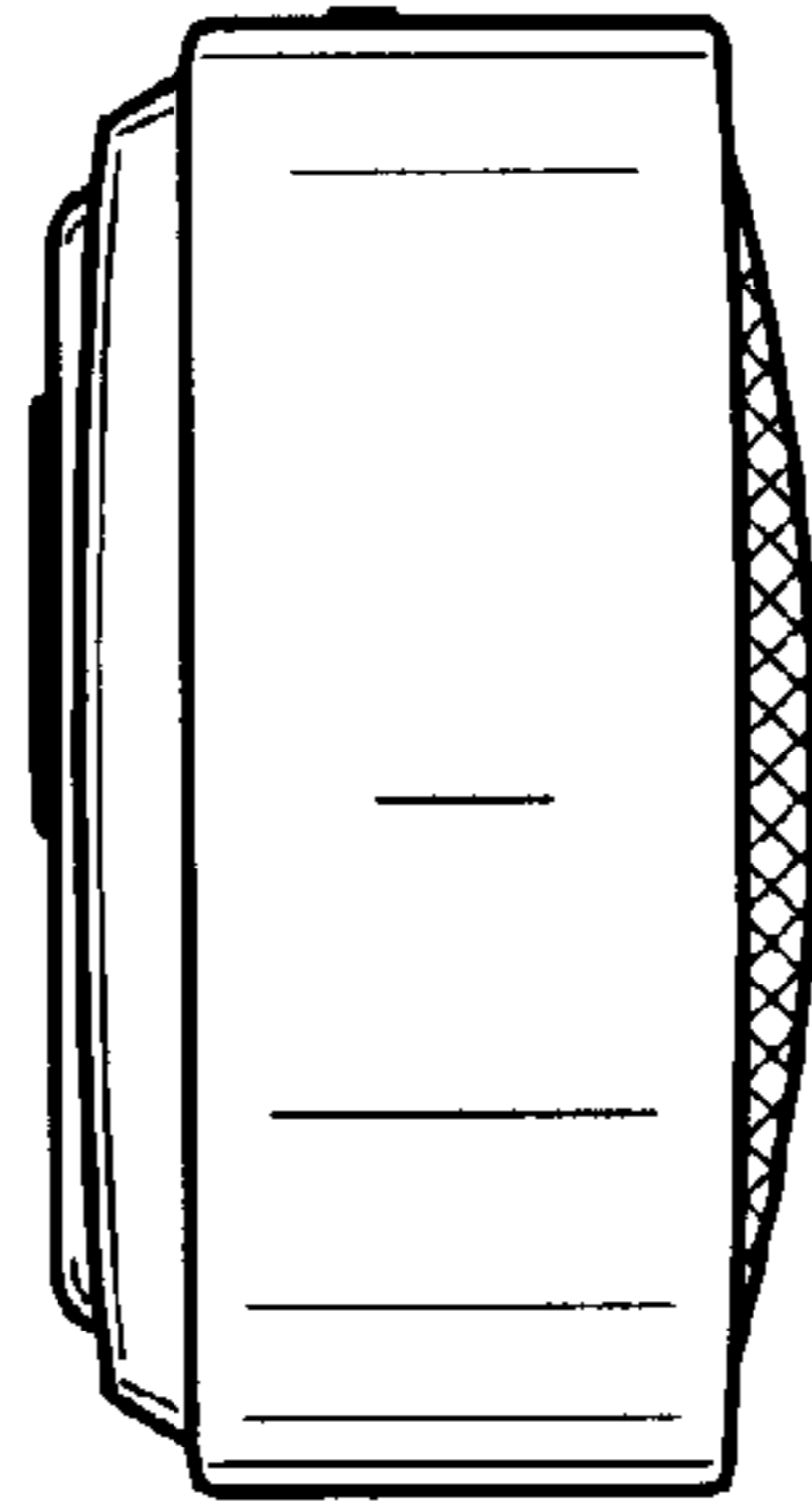

FIG. 5

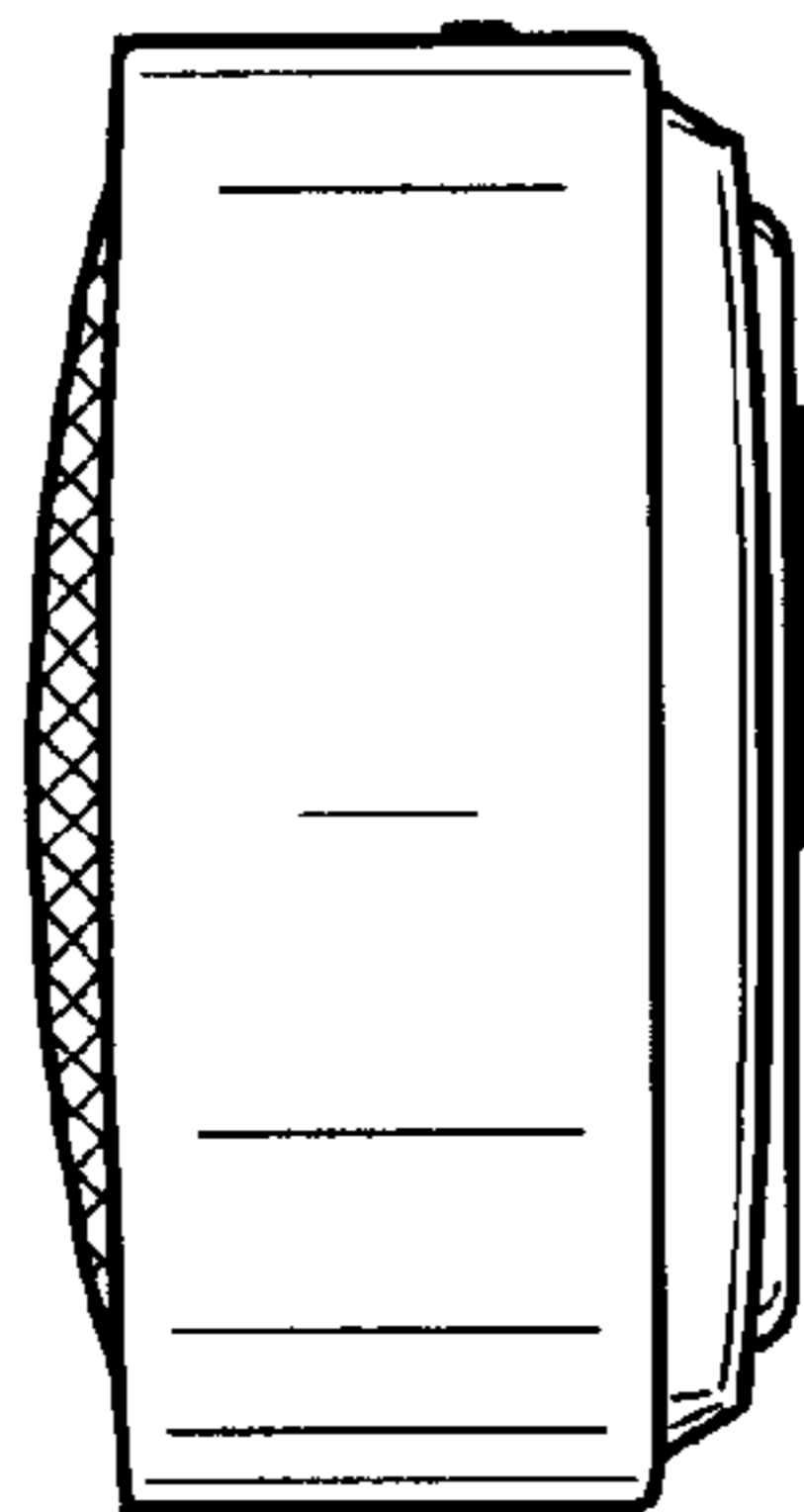

FIG. 6

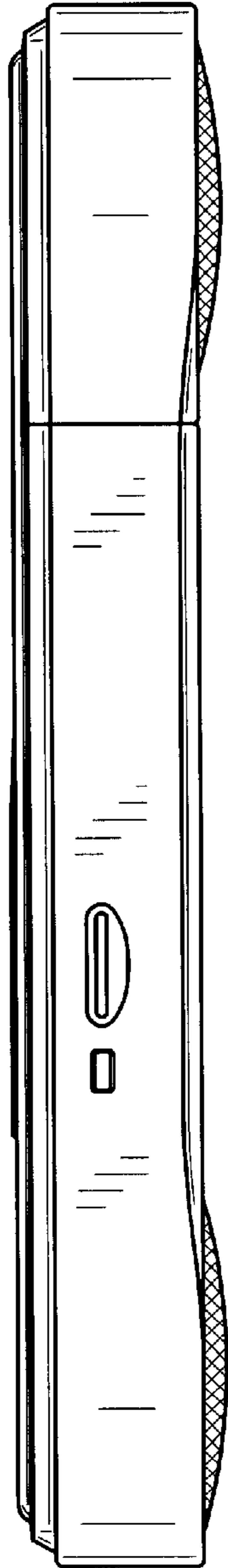

FIG. 7

