



US00D483345S

(12) **United States Design Patent**
Murakami

(10) **Patent No.:** **US D483,345 S**

(45) **Date of Patent:** **** Dec. 9, 2003**

(54) **COMBINED DISC RECORDER, RADIO RECEIVER AND TAPE RECORDER**

(75) Inventor: **Tomonari Murakami**, Tokyo (JP)

(73) Assignee: **Sony Corporation**, Tokyo (JP)

(**) Term: **14 Years**

(21) Appl. No.: **29/172,450**

(22) Filed: **Dec. 12, 2002**

(51) **LOC (7) Cl.** **14-01**

(52) **U.S. Cl.** **D14/168**

(58) **Field of Search** D14/135-136,
D14/156-157, 160-165, 167-168, 188,
193-198; 369/75.1, 75.2, 77.1, 77.2; 381/86,
120; 455/344, 346-351

(56) **References Cited**

U.S. PATENT DOCUMENTS

D425,062 S	*	5/2000	Kokkinis	D14/168
D440,550 S	*	4/2001	Nakano	D14/168
D452,963 S		1/2002	Suzuki		
D460,956 S		7/2002	Zeitman		
D463,782 S	*	10/2002	Chan	D14/196

OTHER PUBLICATIONS

Catalog "Sony Drive", 1 sheet, Sony (Jul. 2002).
Web page "Yodobashi.com: CSD-A555(L)" <http://www8.yodobashi.com/shopping/i.jsp?oid=2765690>, 1 sheet, Yodobashi Camera (Aug. 2002).

* cited by examiner

Primary Examiner—Nanda Bondade

(74) *Attorney, Agent, or Firm*—Rader, Fishman & Grauer PLLC

(57) **CLAIM**

The ornamental design for a combined disc recorder, radio receiver and tape recorder, as shown.

DESCRIPTION

FIG. 1 is a perspective view of a combined disc recorder, radio receiver and tape recorder showing my new design; FIG. 2 is a front elevational view thereof; FIG. 3 is a rear elevational view thereof; FIG. 4 is a left side elevational view thereof; FIG. 5 is a right side elevational view thereof; FIG. 6 is a top plan view thereof; and, FIG. 7 is a bottom plan view thereof.

1 Claim, 5 Drawing Sheets

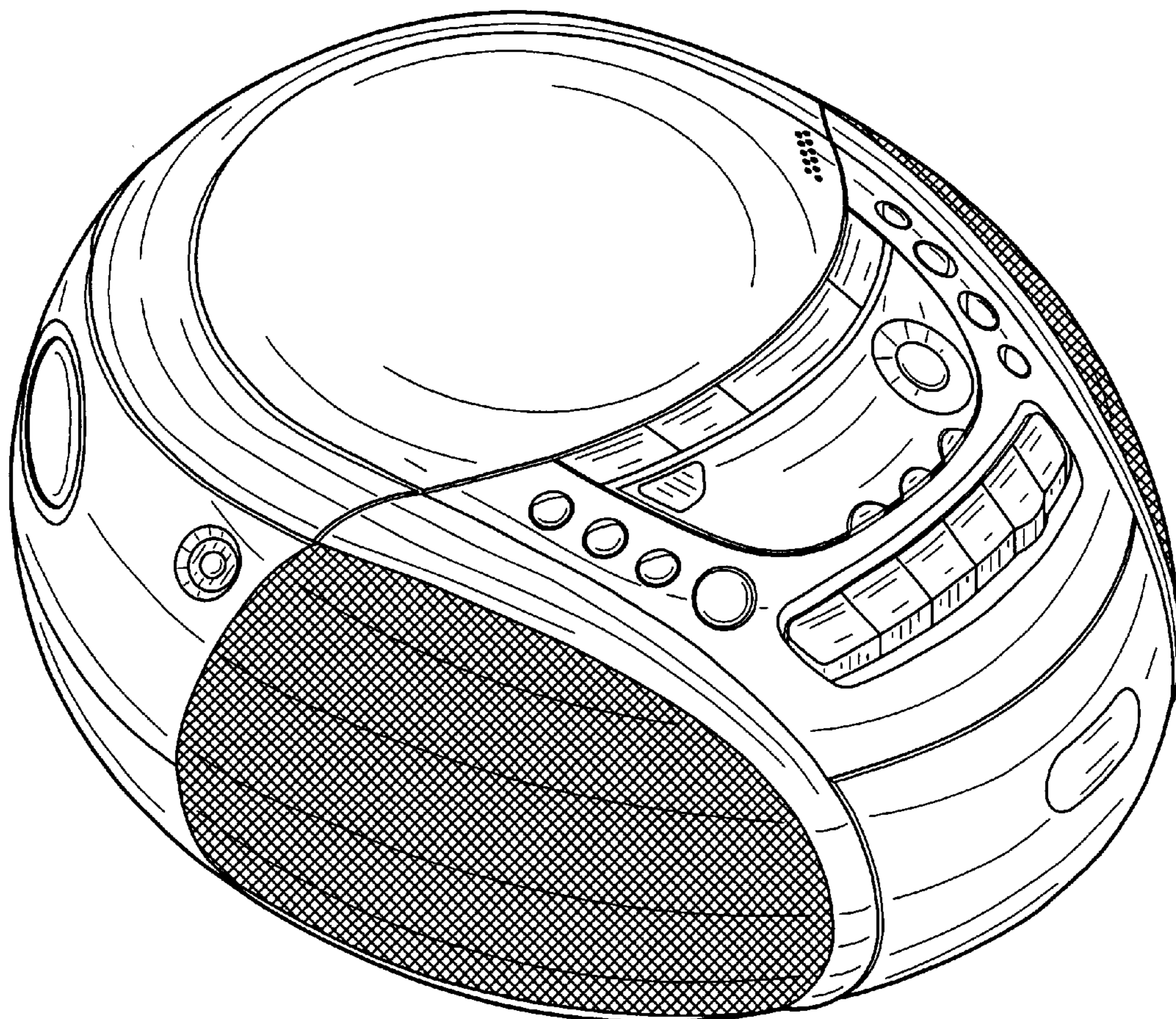

FIG. 1

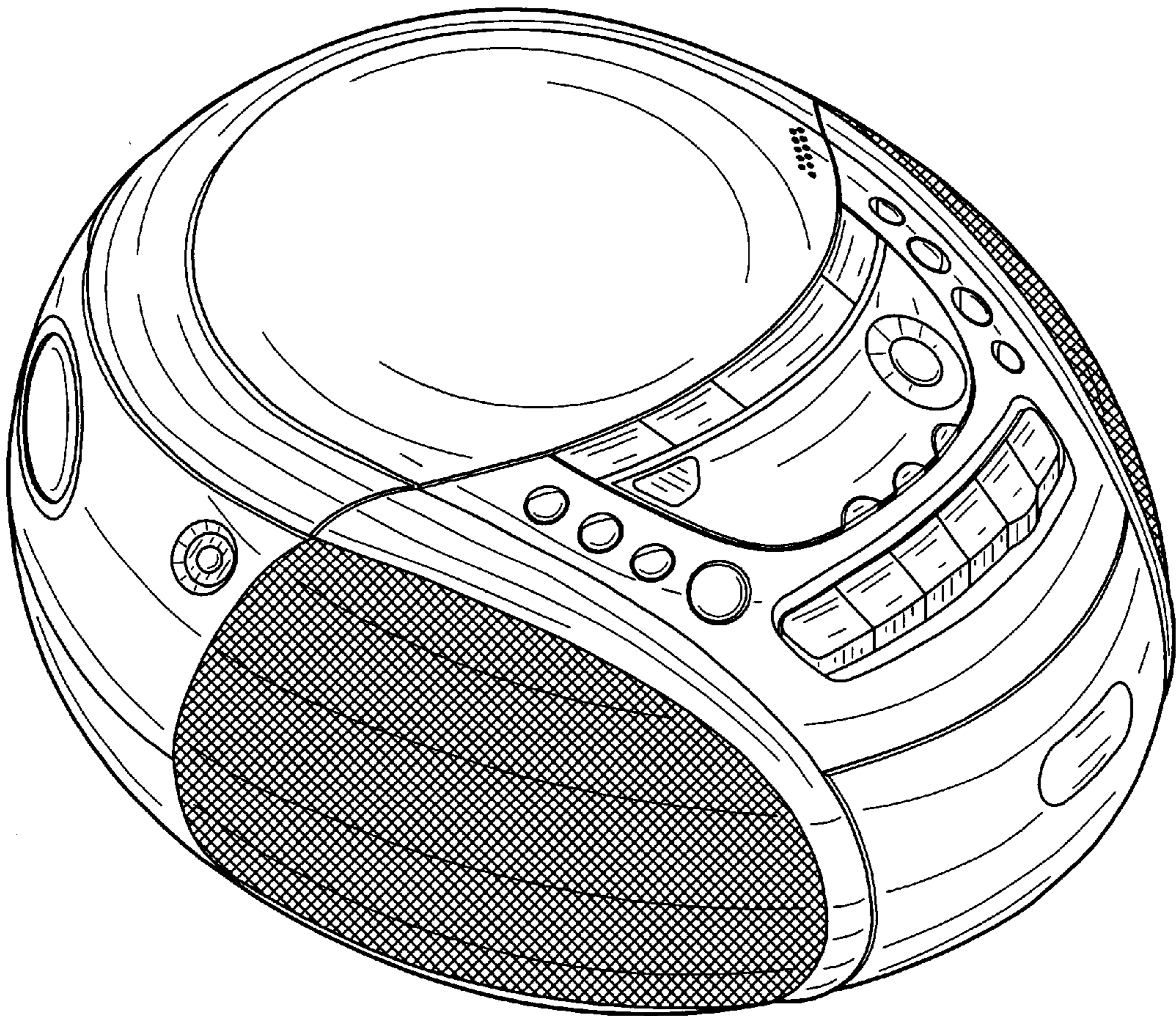

FIG. 2

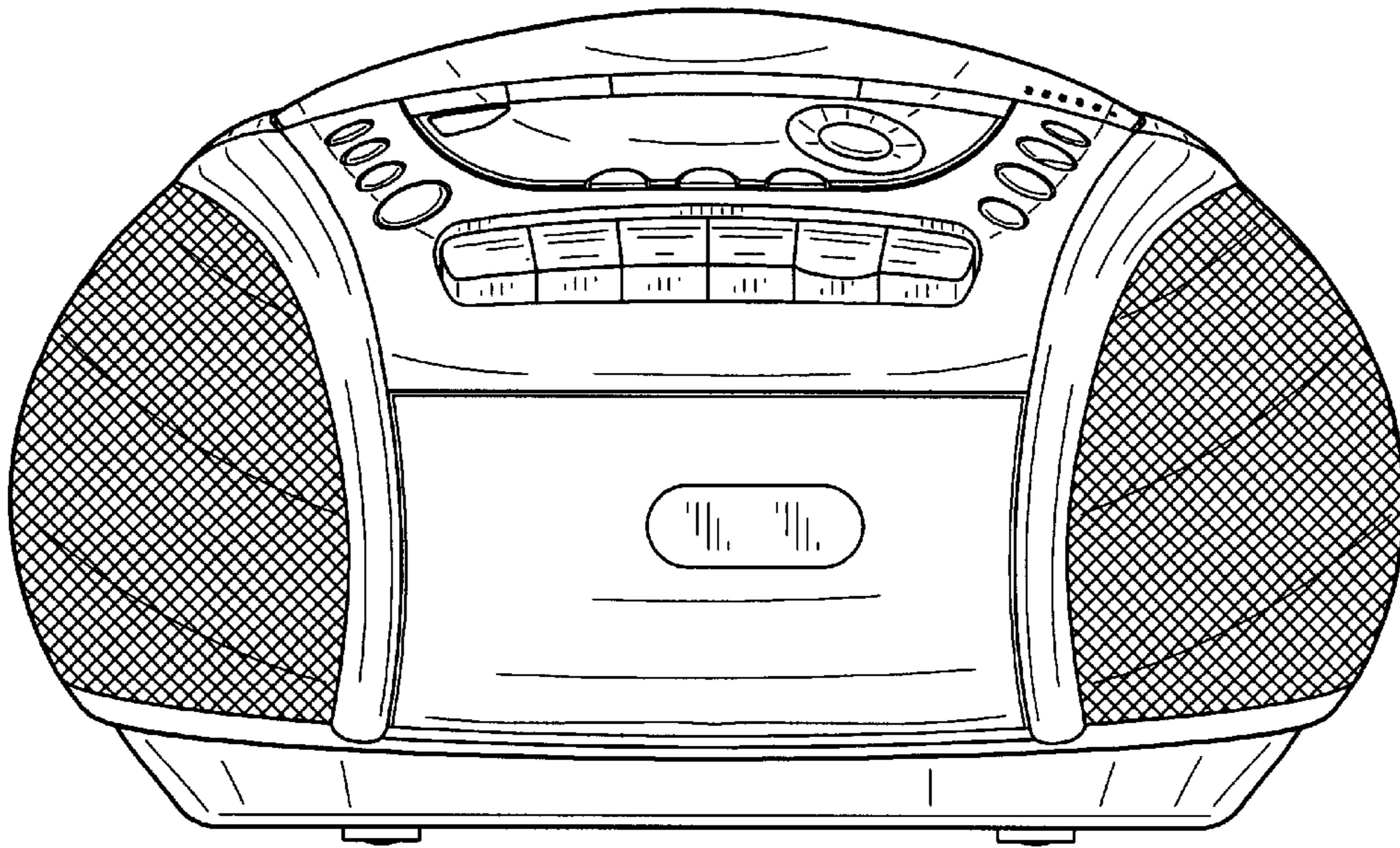

FIG. 3

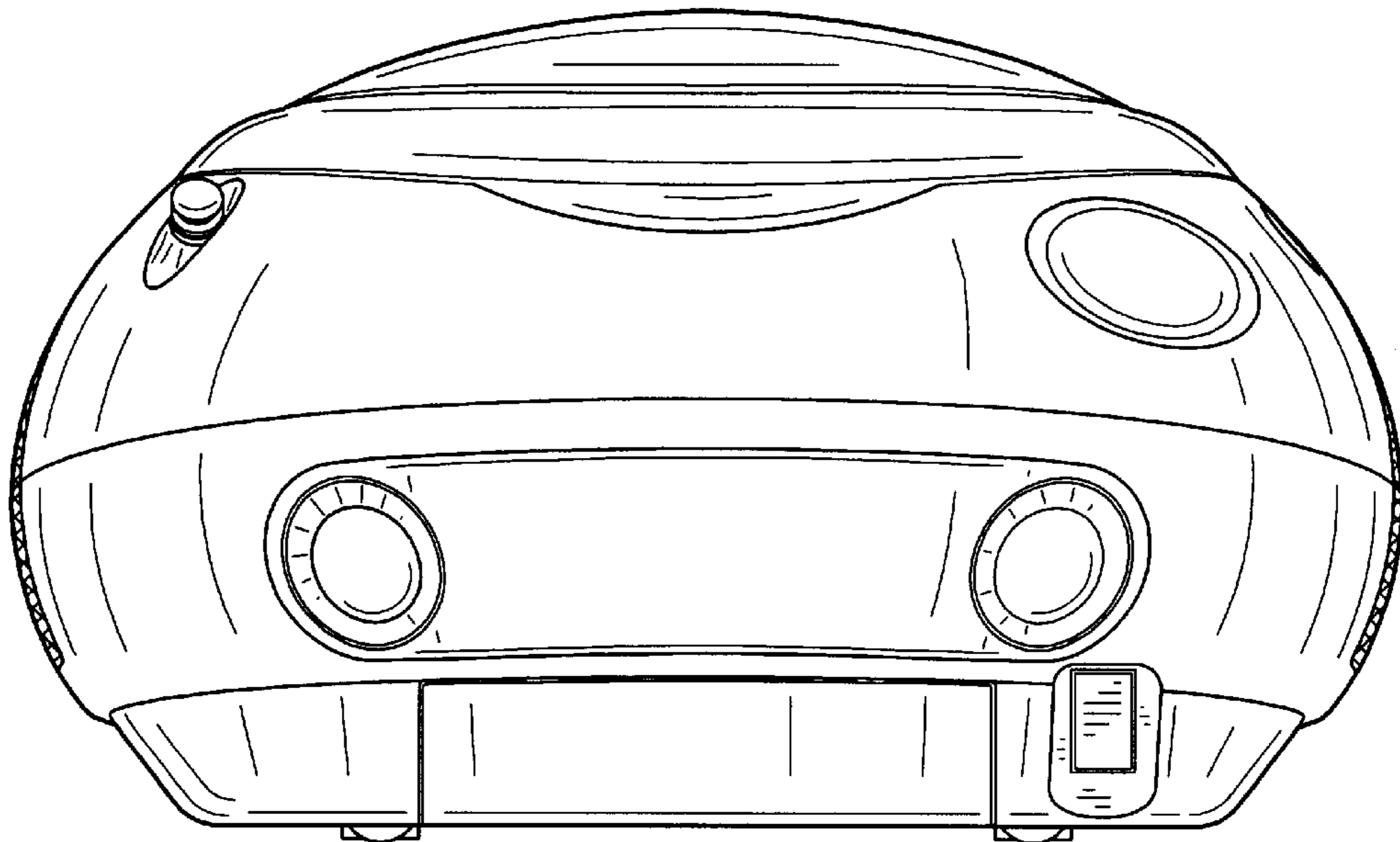

FIG. 4

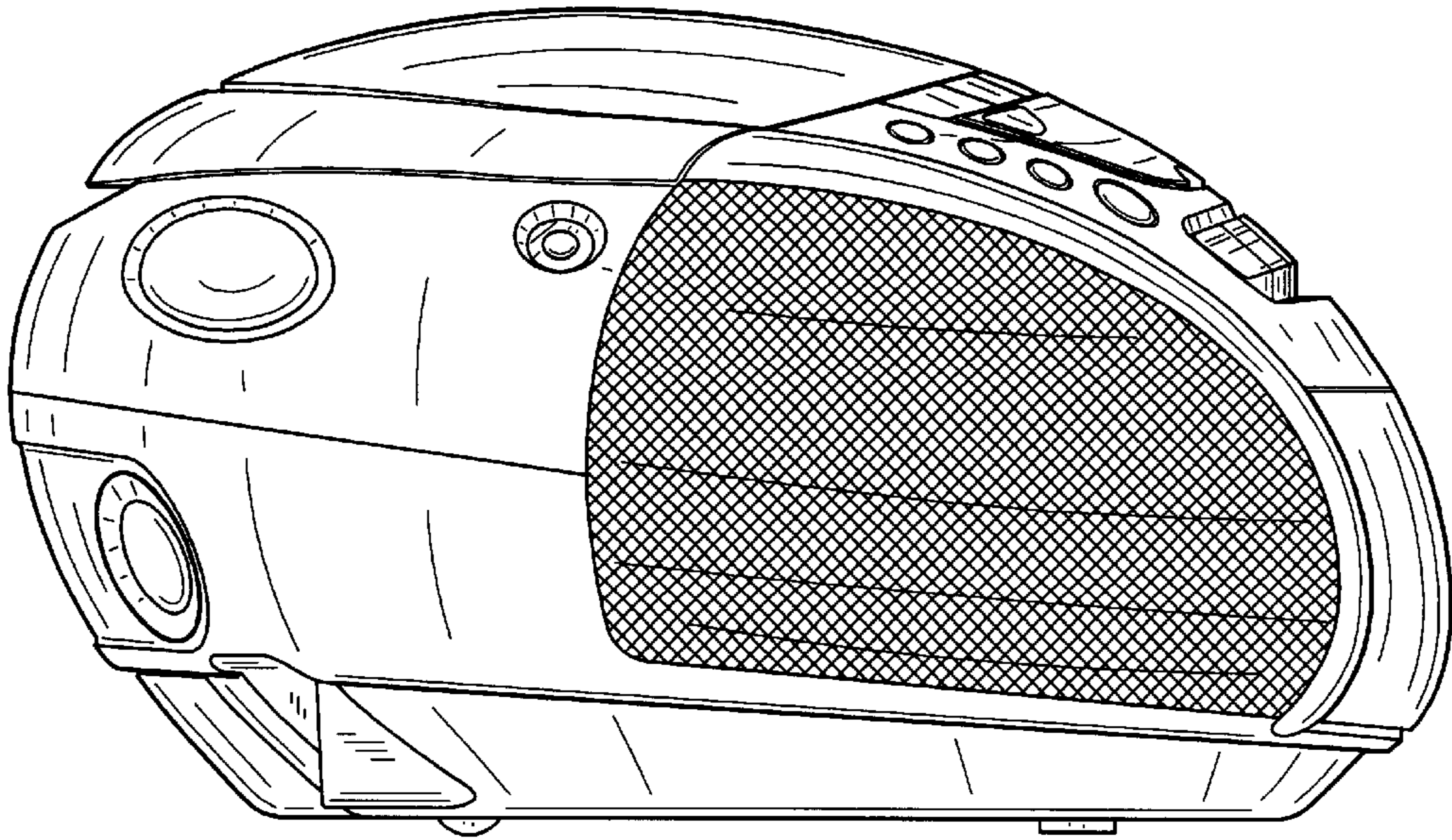

FIG. 5

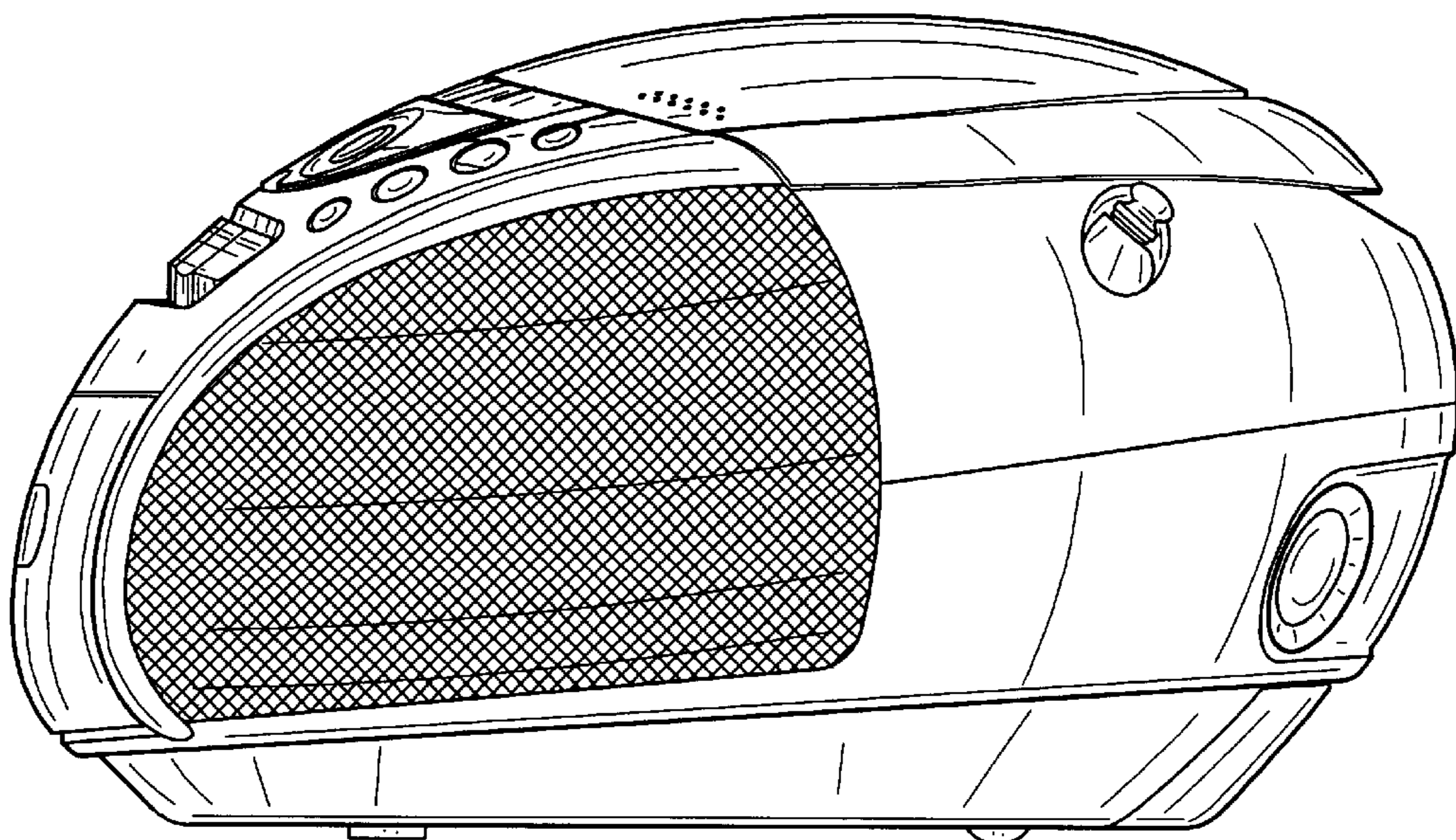

FIG. 6

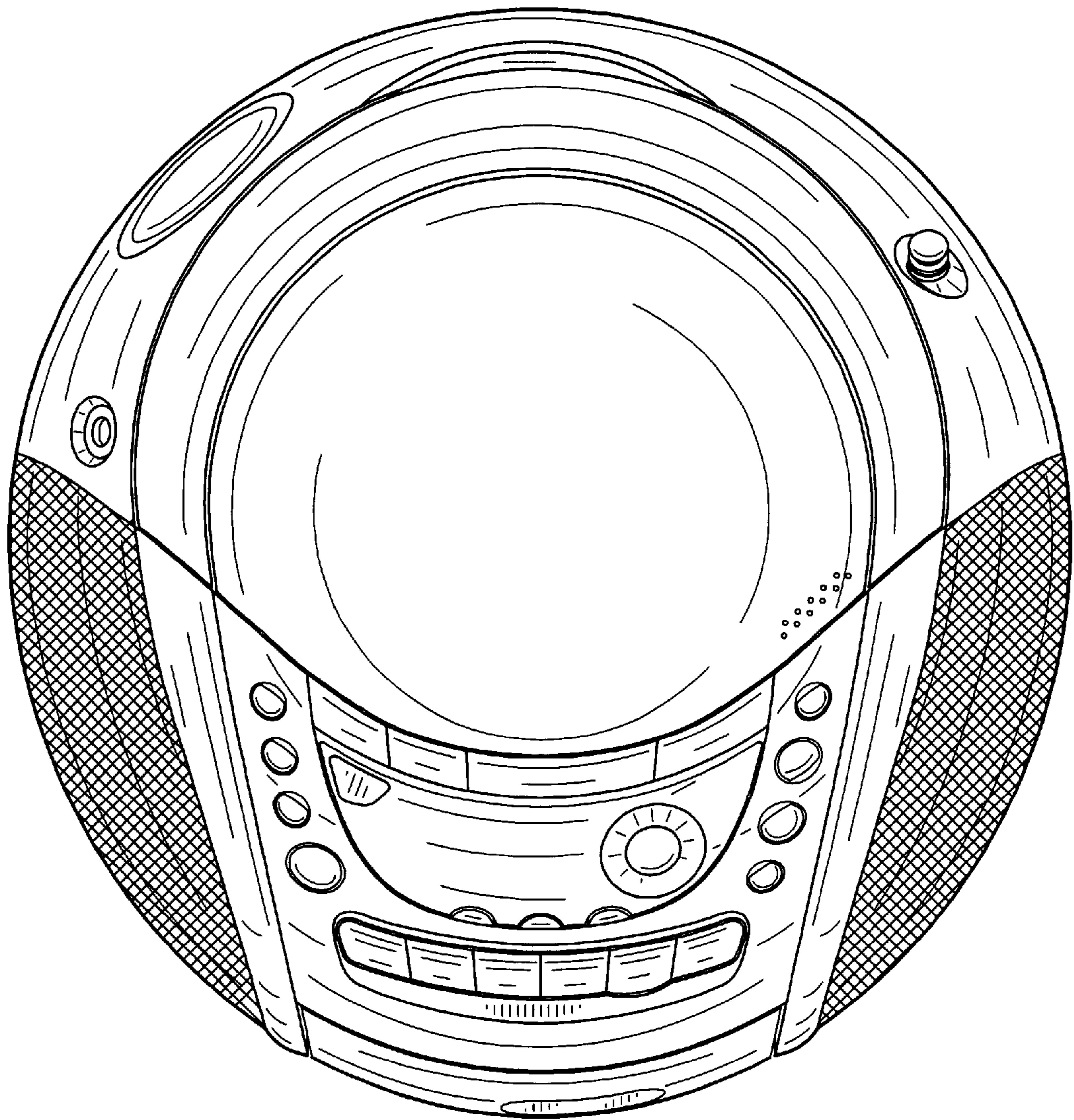

FIG. 7

