



US00D483272S

(12) **United States Design Patent**
Canino

(10) **Patent No.:** **US D483,272 S**

(45) **Date of Patent:** **** Dec. 9, 2003**

(54) **PAPERBOARD BOTTLE WITH ARCED HANDLE**

(75) **Inventor:** **Paul A. Canino**, Milford, OH (US)

(73) **Assignee:** **International Paper Company**,
Tuxedo, NY (US)

(**) **Term:** **14 Years**

(21) **Appl. No.:** **29/175,656**

(22) **Filed:** **Feb. 10, 2003**

Related U.S. Application Data

(63) Continuation-in-part of application No. 29/164,474, filed on Jul. 26, 2002, now Pat. No. Des. 475,630.

(51) **LOC (7) Cl.** **09-03**

(52) **U.S. Cl.** **D9/528**

(58) **Field of Search** D9/500, 501, 503,
D9/516, 517, 523, 528, 531, 537, 542,
543, 549, 574, 575; 206/527; 215/40, 43,
44, 200, 316, 329, 354, 400

(56) **References Cited**

U.S. PATENT DOCUMENTS

D54,983 S * 4/1920 Gatchell D9/506
D55,641 S * 7/1920 Price D9/524
D60,342 S * 2/1922 Haskell D9/506

D128,513 S * 7/1941 Wittie D9/506
D158,997 S * 6/1950 Parker D7/300
D240,314 S * 6/1976 Chlystun D9/526
D266,400 S * 10/1982 Shatz D9/337

* cited by examiner

Primary Examiner—Nanda Bondade

Assistant Examiner—Daniel Bui

(74) *Attorney, Agent, or Firm*—Stewart L. Gitler; Michael J. Doyle

(57) **CLAIM**

The ornamental design for a paperboard bottle with arced handle, as shown and described.

DESCRIPTION

FIG. 1 is a top plan view of the paperboard bottle with arced handle;
FIG. 2 is a front view of the paperboard bottle with arced handle;
FIG. 3 is a side view of the paperboard bottle with arced handle;
FIG. 4 is a rear view of the paperboard bottle with arced handle;
FIG. 5 is a bottom plan view of the paperboard bottle with arced handle; and,
FIG. 6 is a cross-sectional view along the line A—A of FIG. 3.

1 Claim, 1 Drawing Sheet

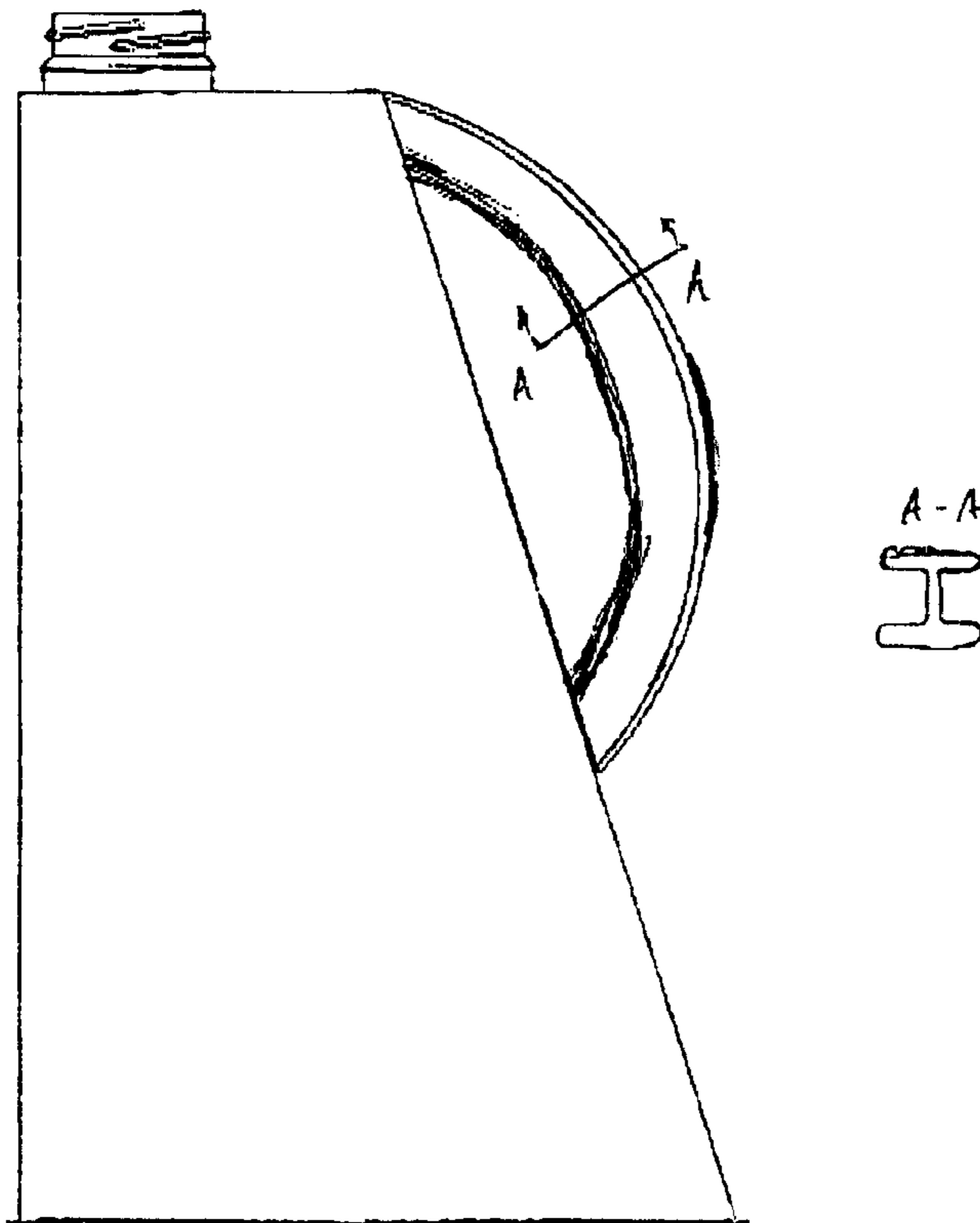

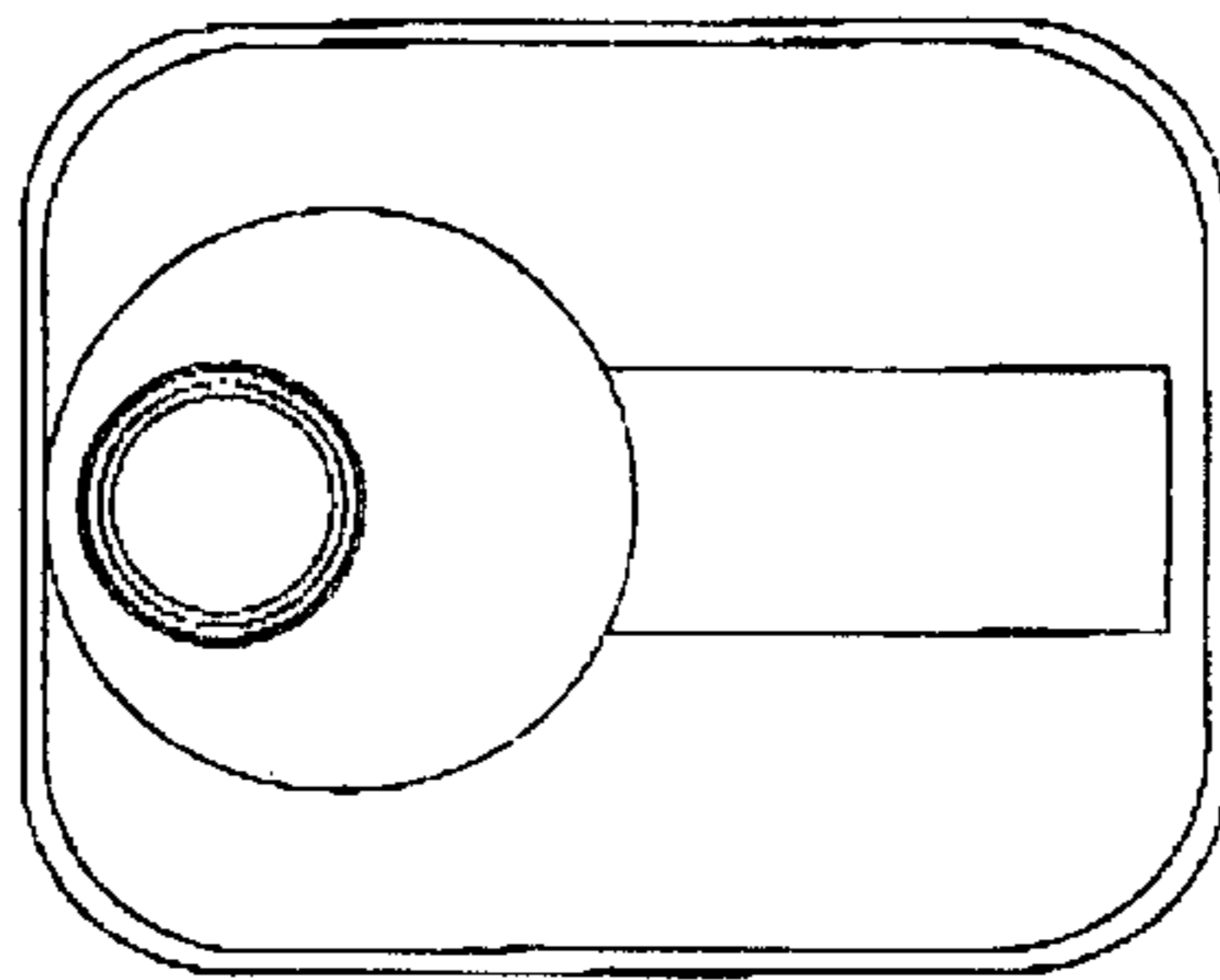

FIG 1

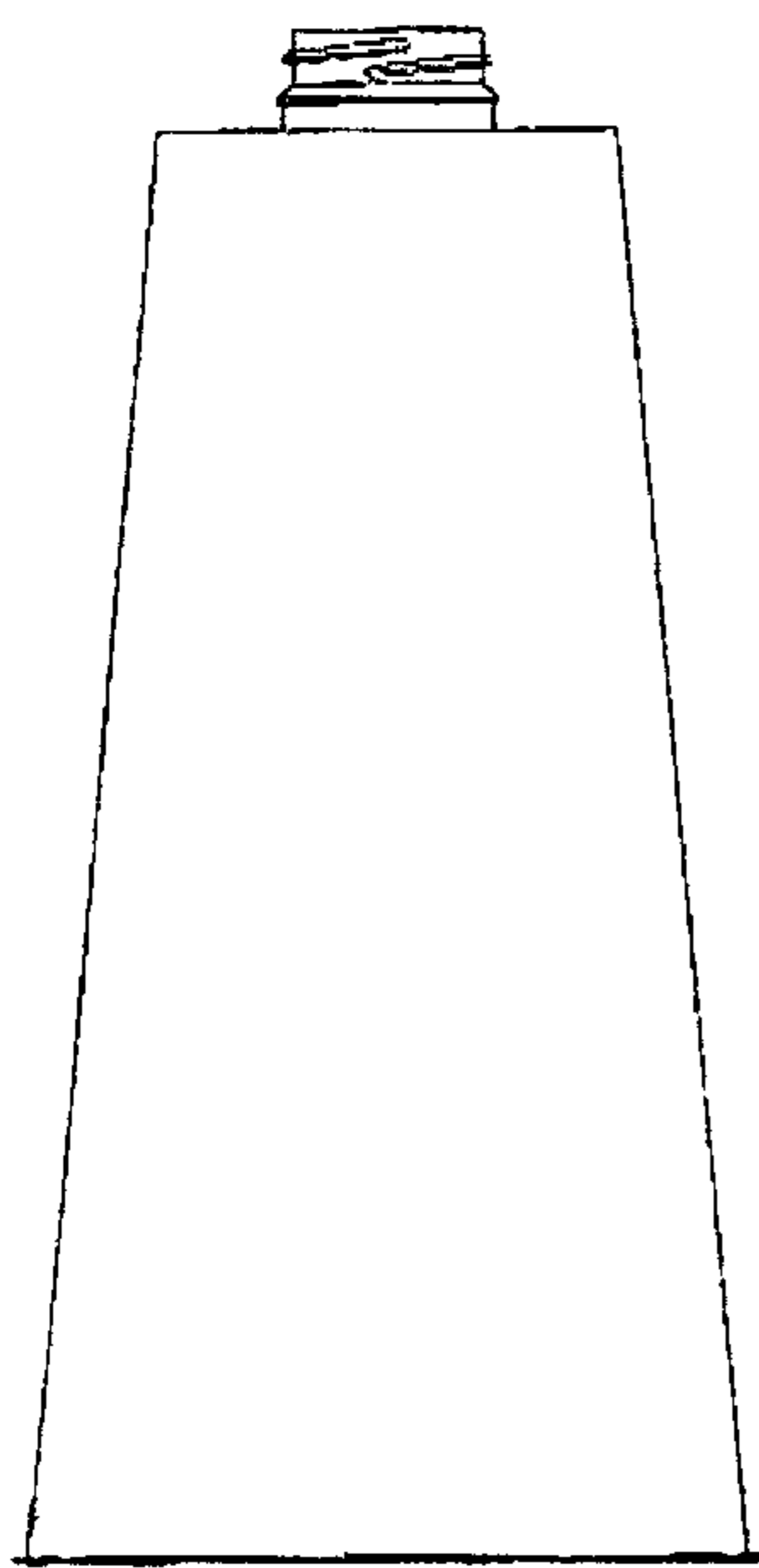

FIG. 2

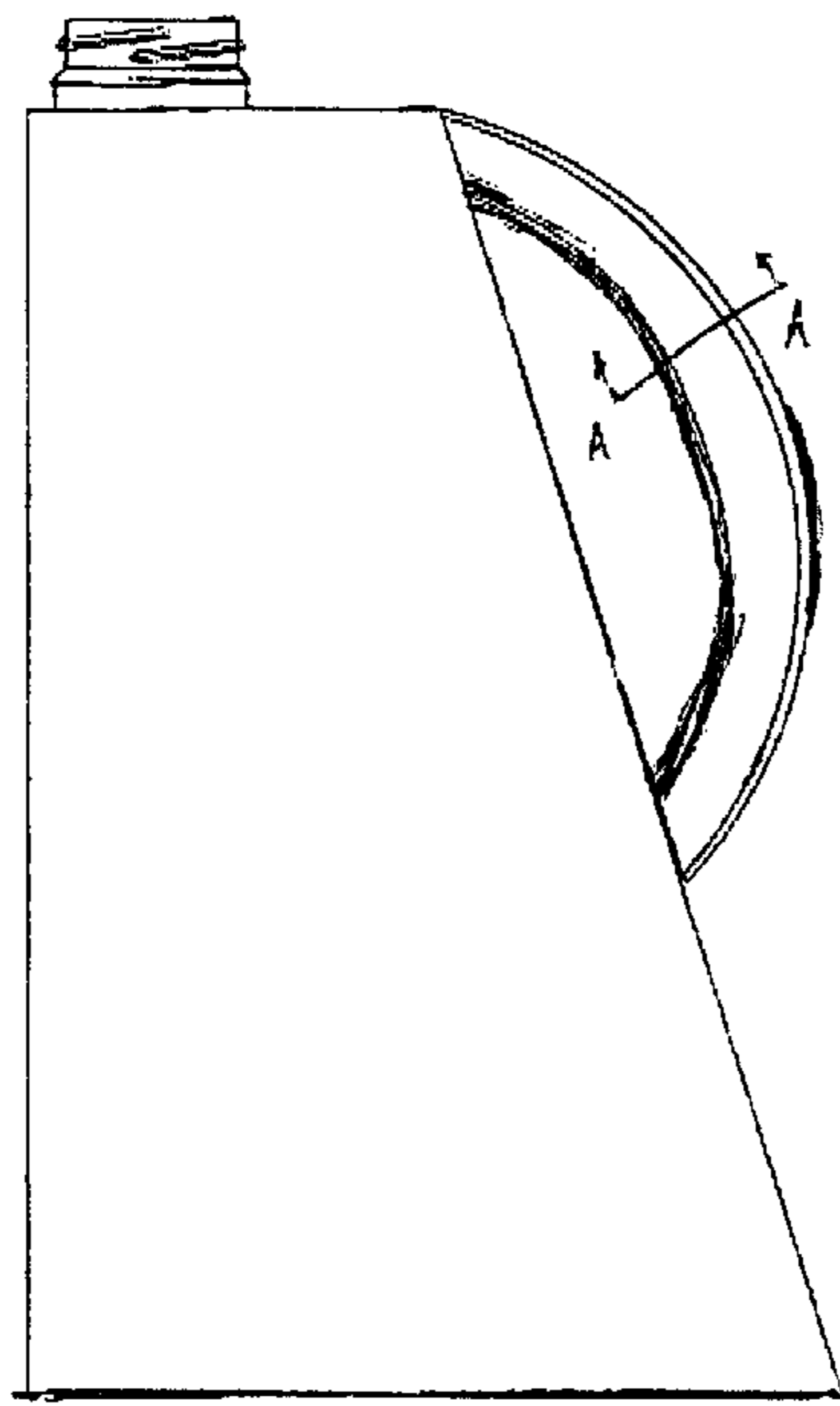

FIG 3

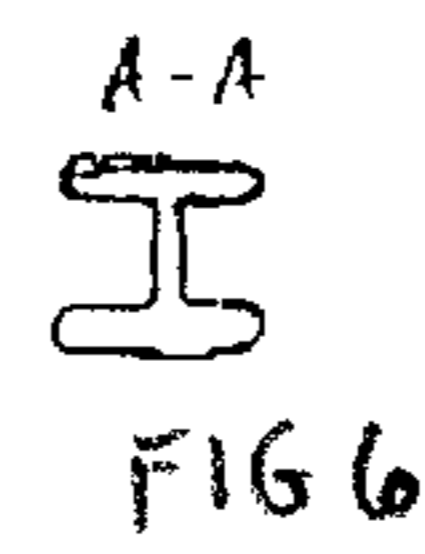

FIG 6

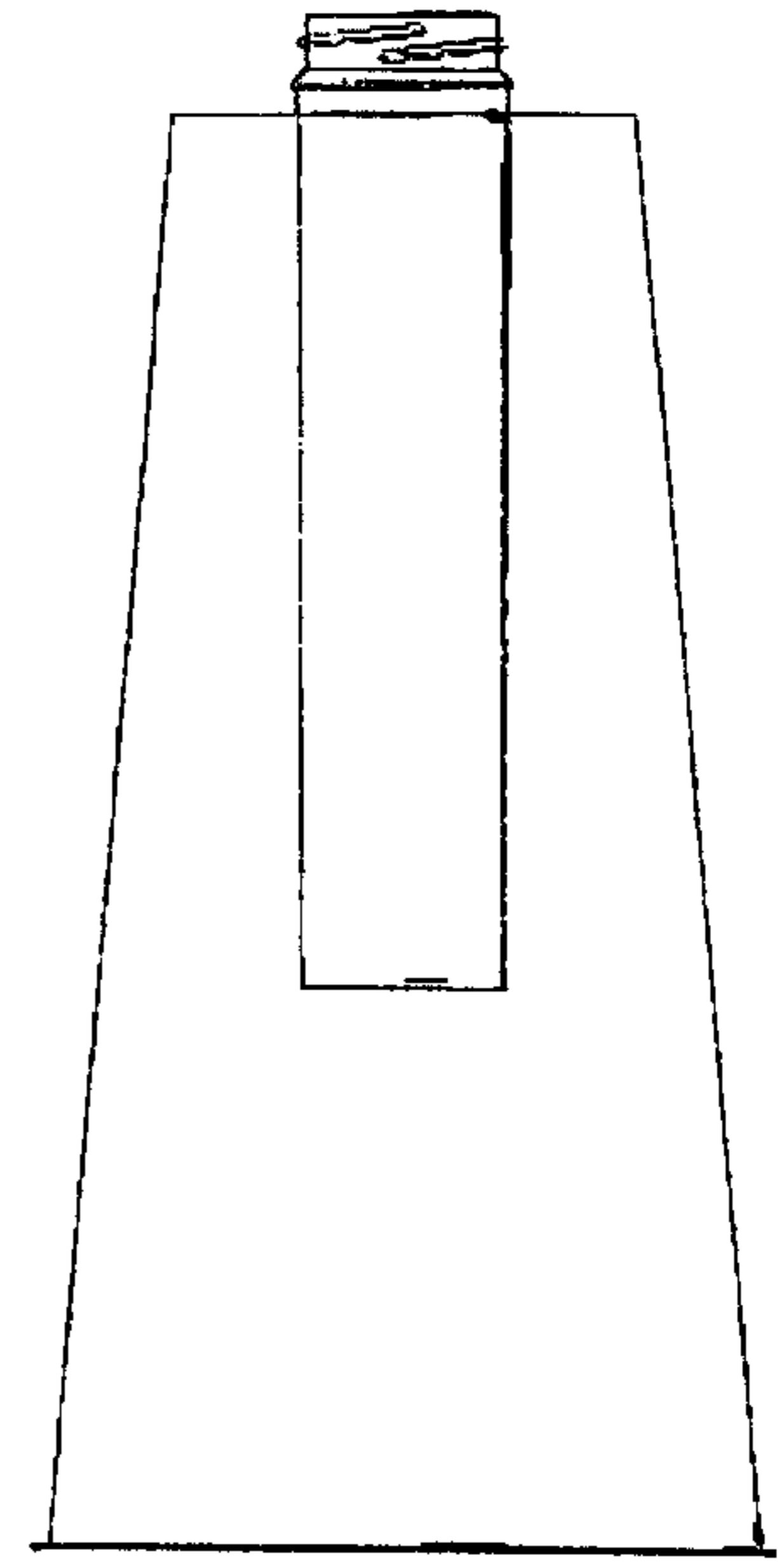

FIG 4

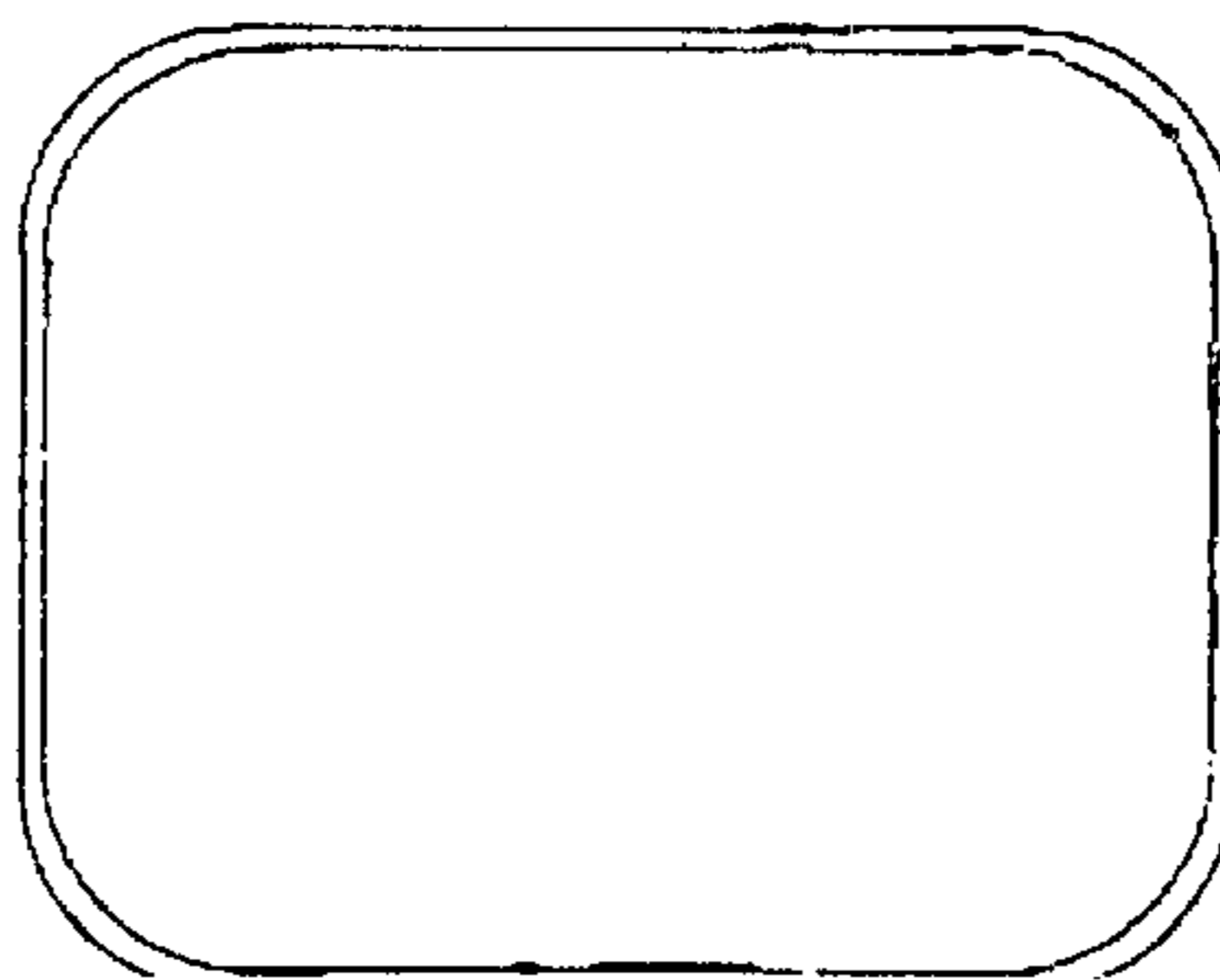

FIG 5