



US00D483232S

(12) **United States Design Patent**
Liu

(10) **Patent No.:** **US D483,232 S**

(45) **Date of Patent:** **** Dec. 9, 2003**

(54) **COVERED FOOD CONTAINER**

(75) Inventor: **Anita Suk Ping Liu**, Orlando, FL (US)

(73) Assignee: **Dart Industries Inc.**, Orlando, FL (US)

(**) Term: **14 Years**

(21) Appl. No.: **29/172,392**

(22) Filed: **Dec. 11, 2002**

(51) **LOC (7) Cl.** **07-07**

(52) **U.S. Cl.** **D7/629; D7/614**

(58) **Field of Search** D7/612-615, 601,
D7/602, 629, 538-542; D9/414, 424, 425,
430-432; D3/201, 203, 205, 206, 273,
274, 281, 282; 220/574, 574.1, 669-676,
780-799; 229/406, 407, 902, 938

(56) **References Cited**

U.S. PATENT DOCUMENTS

D57,707 S	*	4/1921	Morrison	D9/430
D263,283 S		3/1982	Ronayne		
D312,777 S		12/1990	Courreges		
D343,338 S		1/1994	Bucher et al.		
D343,340 S		1/1994	Frye et al.		
D370,152 S		5/1996	Kostelni		
D376,734 S	*	12/1996	Petrie	D7/629
D409,911 S	*	5/1999	Guillin	D9/430
D415,385 S	*	10/1999	Loew et al.	D7/392.1
D423,370 S		4/2000	Lewin	D9/572
D439,162 S	*	3/2001	Juhng	D9/430
D439,774 S		4/2001	Lee	D6/501
D443,471 S		6/2001	Lillelund et al.	D7/398
D445,650 S		7/2001	Maxwell et al.	D7/629
D448,969 S		10/2001	Conti	D7/392.1

* cited by examiner

Primary Examiner—Terry A. Wallace

(74) *Attorney, Agent, or Firm*—John A. Doninger

(57) **CLAIM**

The ornamental design for a covered food container, as shown and described.

DESCRIPTION

FIG. 1 is a top, side and front perspective view of a first embodiment of a covered food container showing the new design;

FIG. 2 is a front elevation view thereof;

FIG. 3 is a rear elevation view thereof;

FIG. 4 is a right side elevation view thereof;

FIG. 5 is a left side elevation view thereof;

FIG. 6 is a top plan view thereof;

FIG. 7 is a bottom plan view thereof;

FIG. 8 is a top, side and front perspective view of a second embodiment of a covered food container showing the new design;

FIG. 9 is a front elevation view thereof

FIG. 10 is a rear elevation view thereof;

FIG. 11 is a right side elevation view thereof;

FIG. 12 is a left side elevation view thereof;

FIG. 13 is a top plan view thereof;

FIG. 14 is a bottom plan view thereof;

FIG. 15 is a top, side and front perspective view of a third embodiment of a covered food container showing the new design;

FIG. 16 is a front elevation view thereof;

FIG. 17 is a rear elevation view thereof;

FIG. 18 is a right side elevation view thereof;

FIG. 19 is a left side elevation view thereof;

FIG. 20 is a top plan view thereof; and,

FIG. 21 is a bottom plan view thereof.

1 Claim, 13 Drawing Sheets

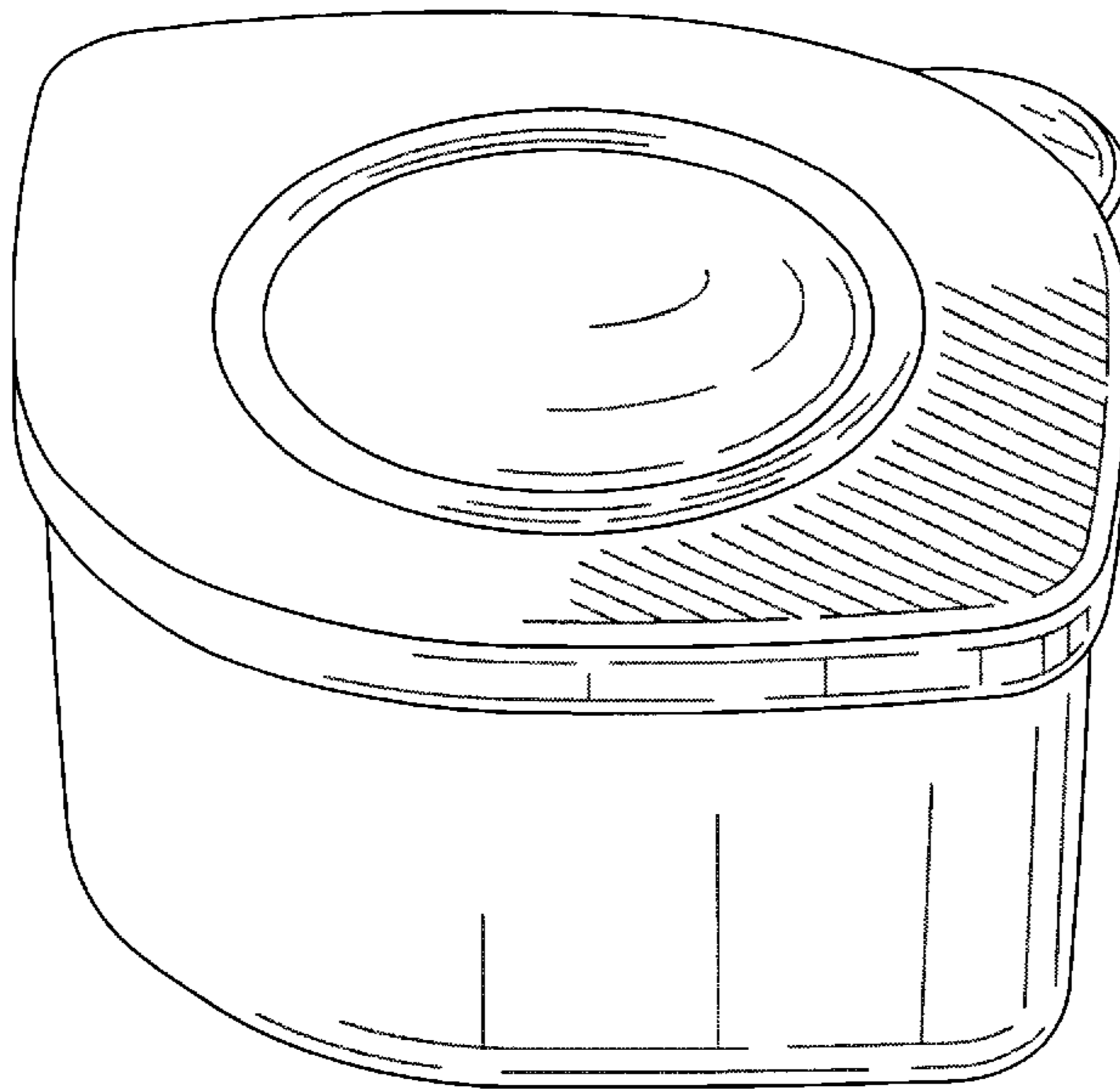

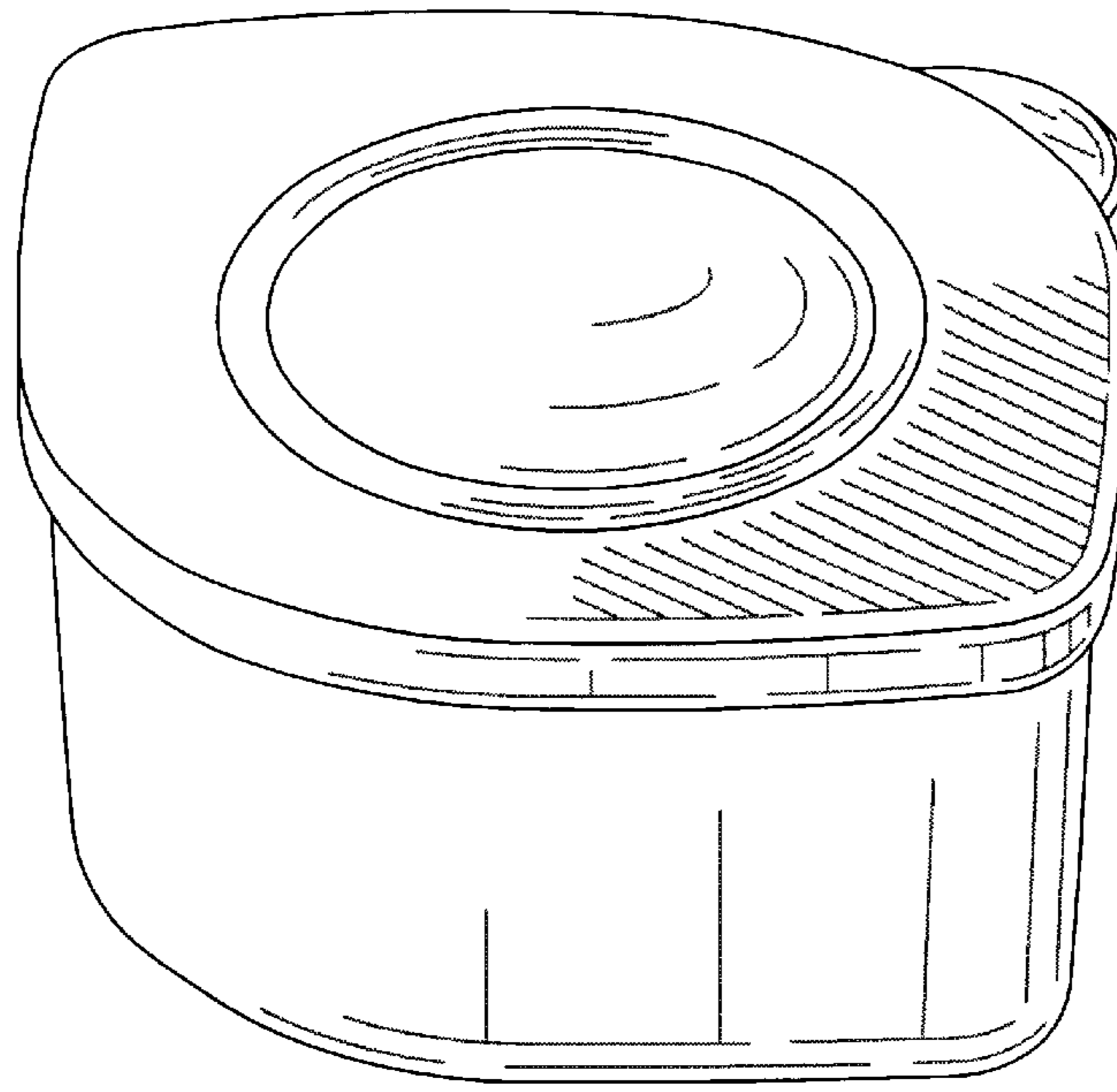

FIG. 1

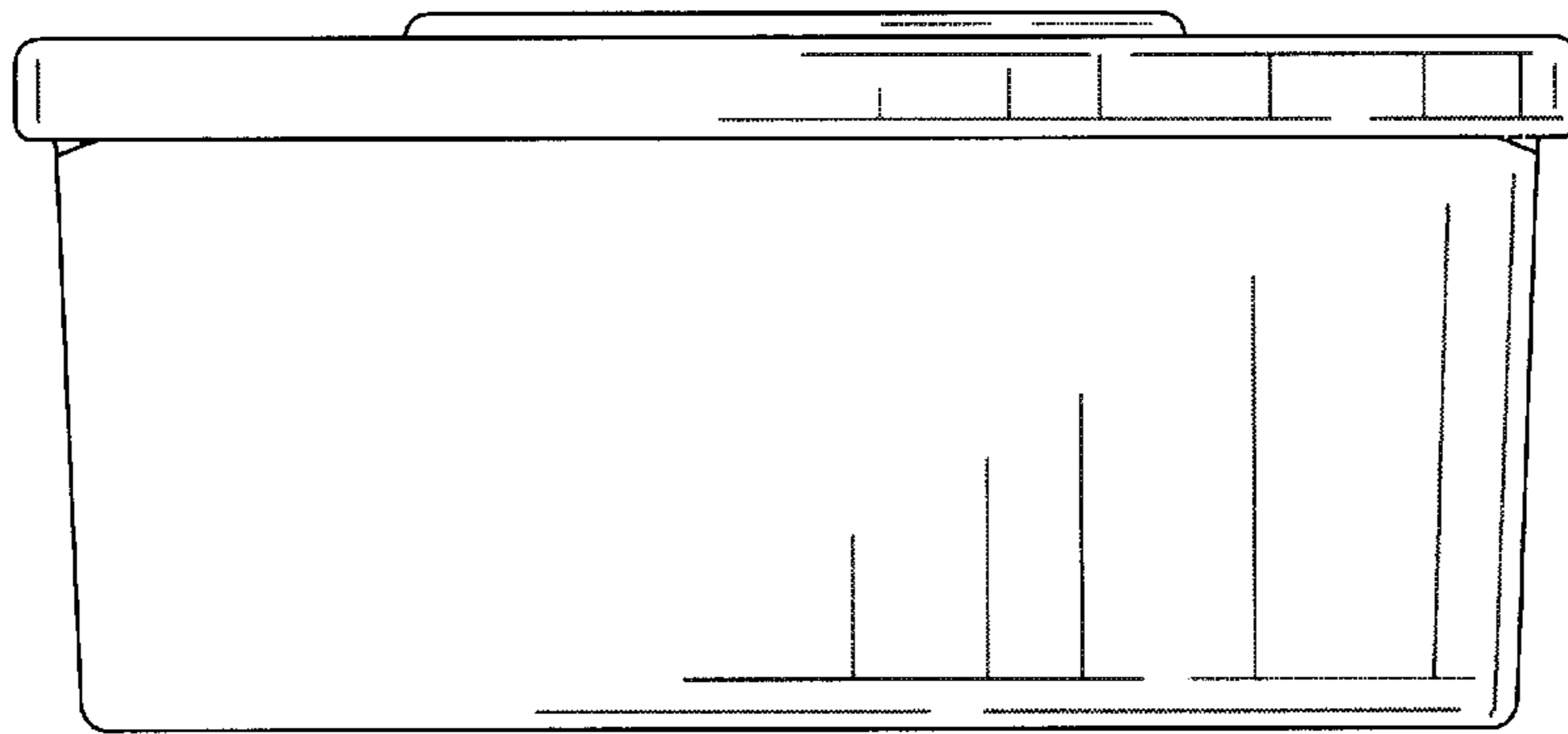

FIG. 2

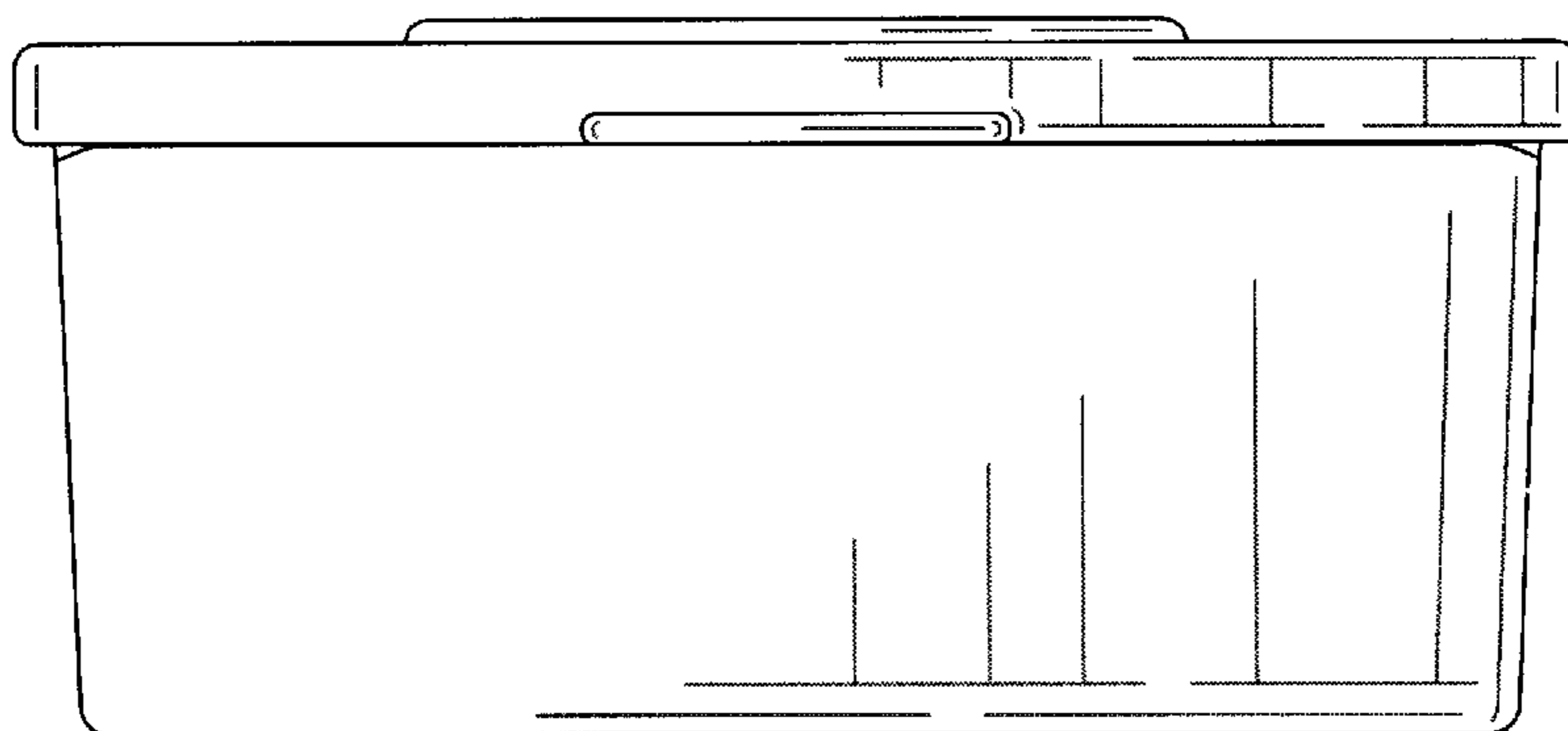

FIG. 3

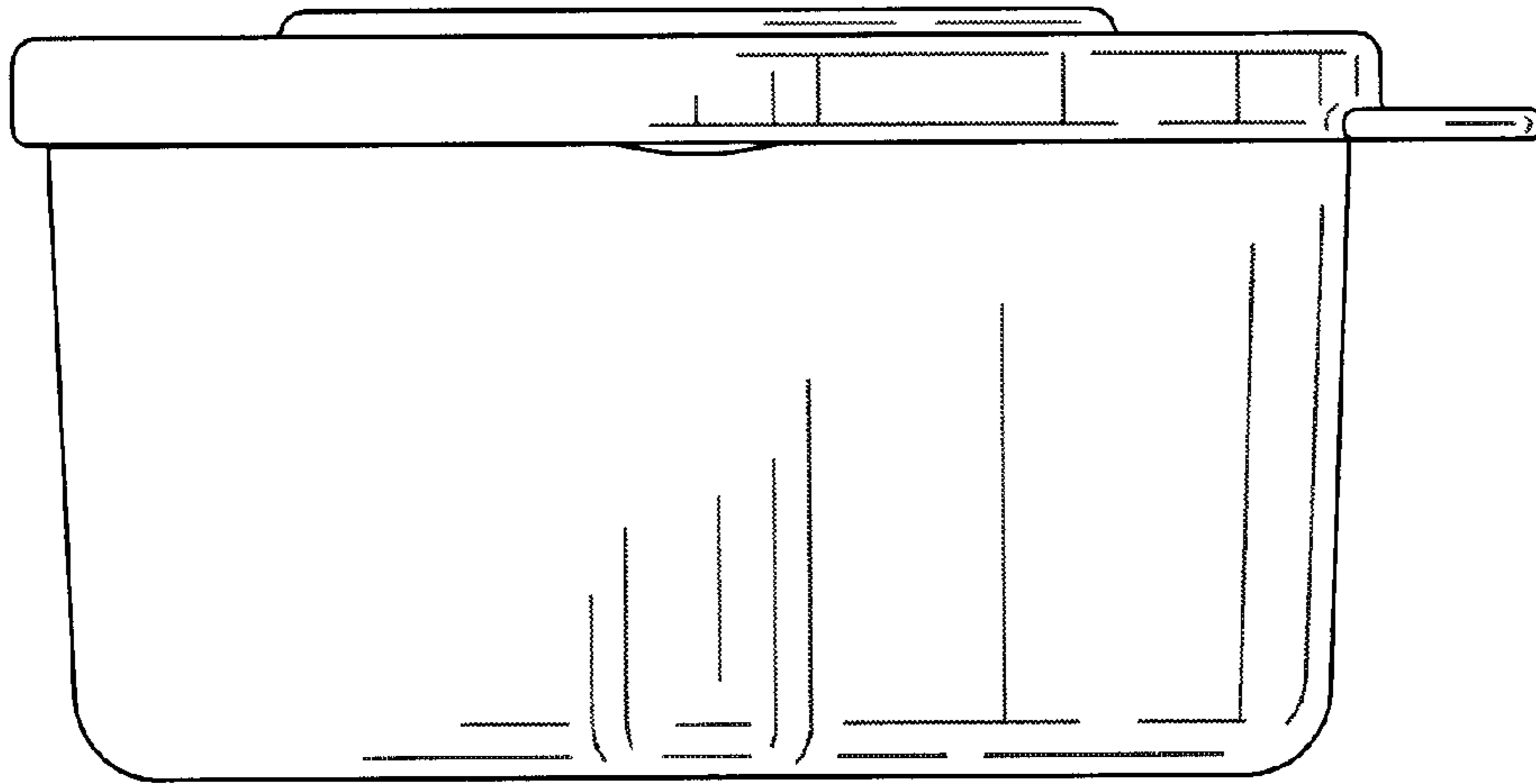

FIG. 4

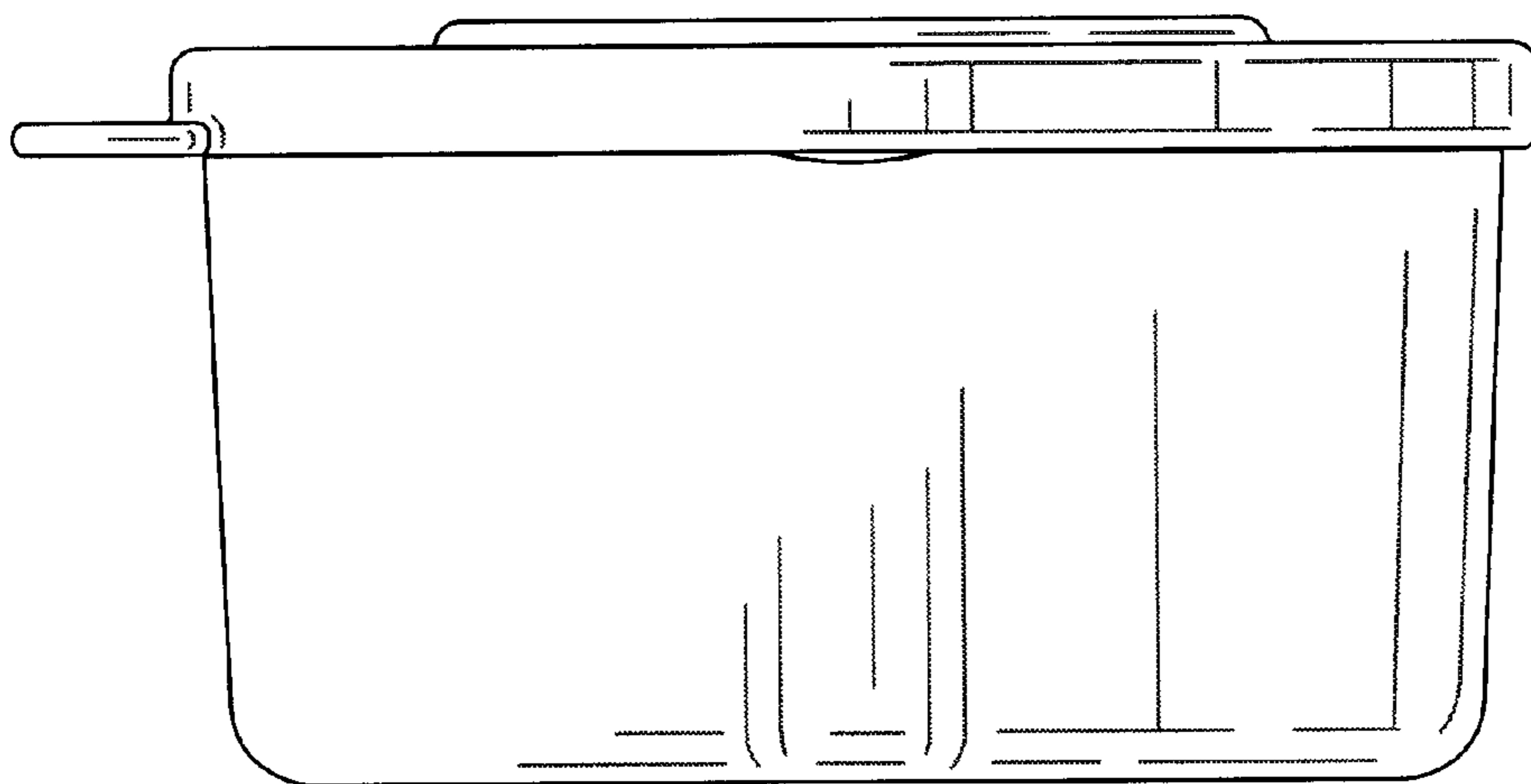

FIG. 5

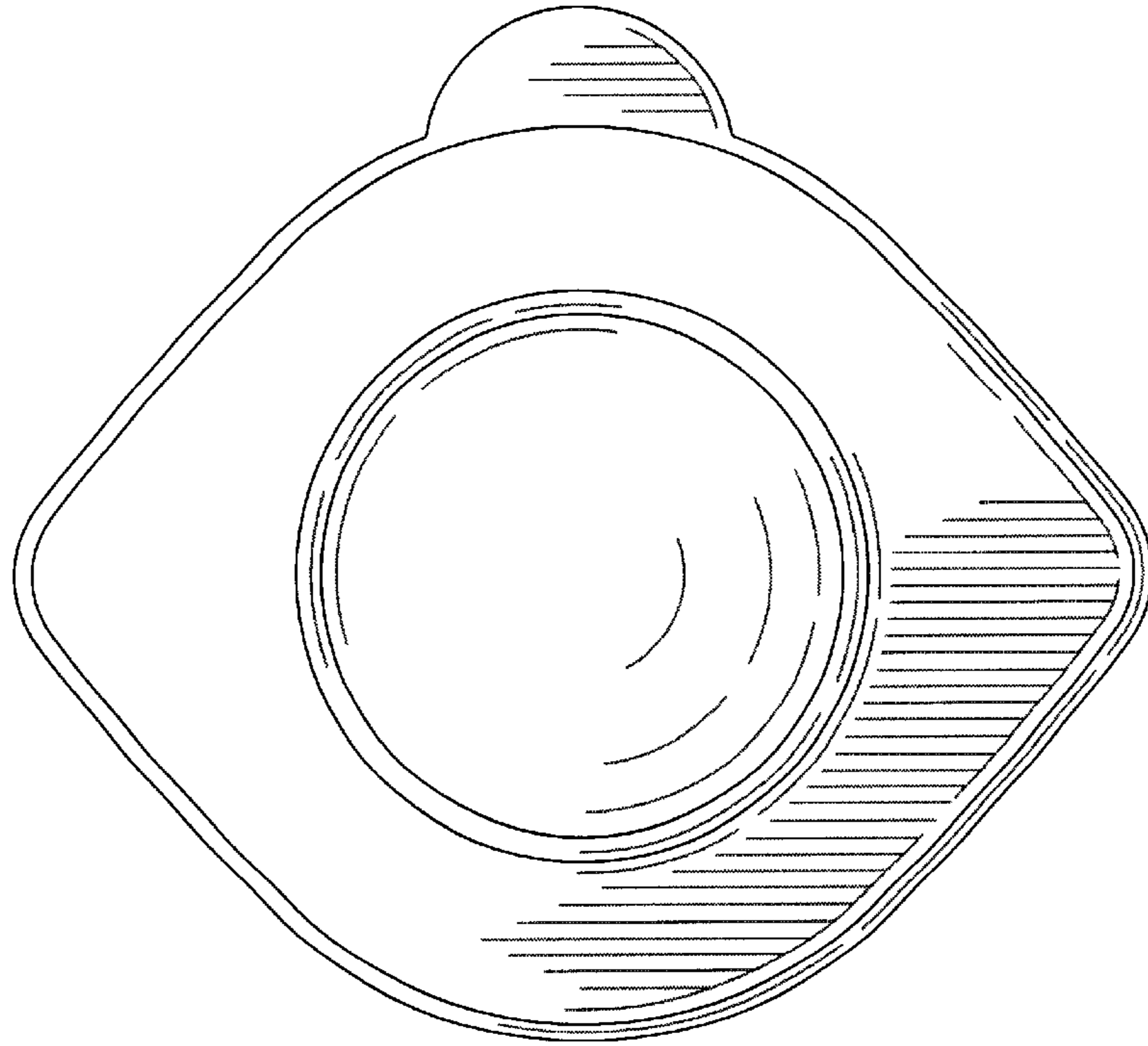

FIG. 6

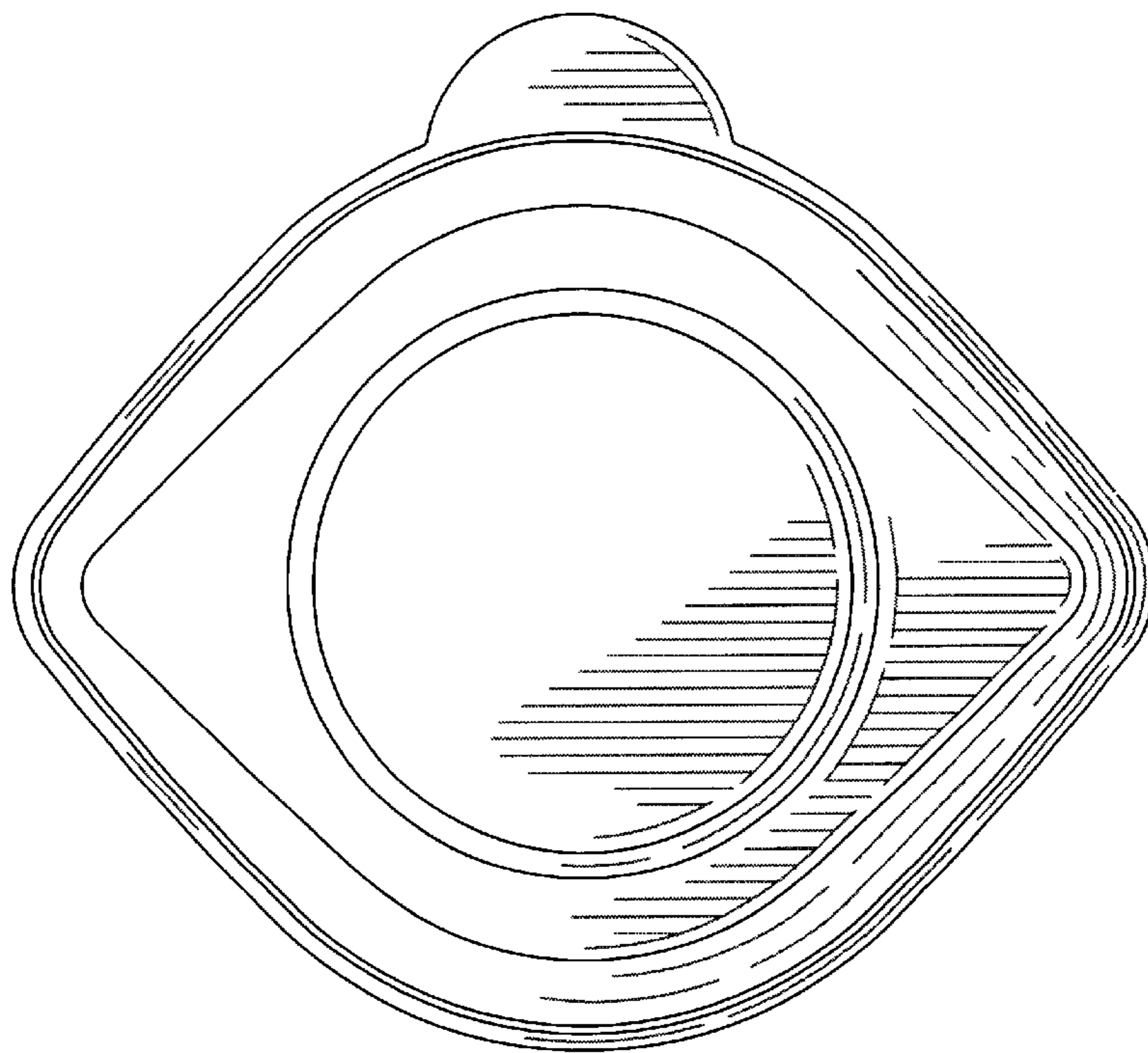

FIG. 7

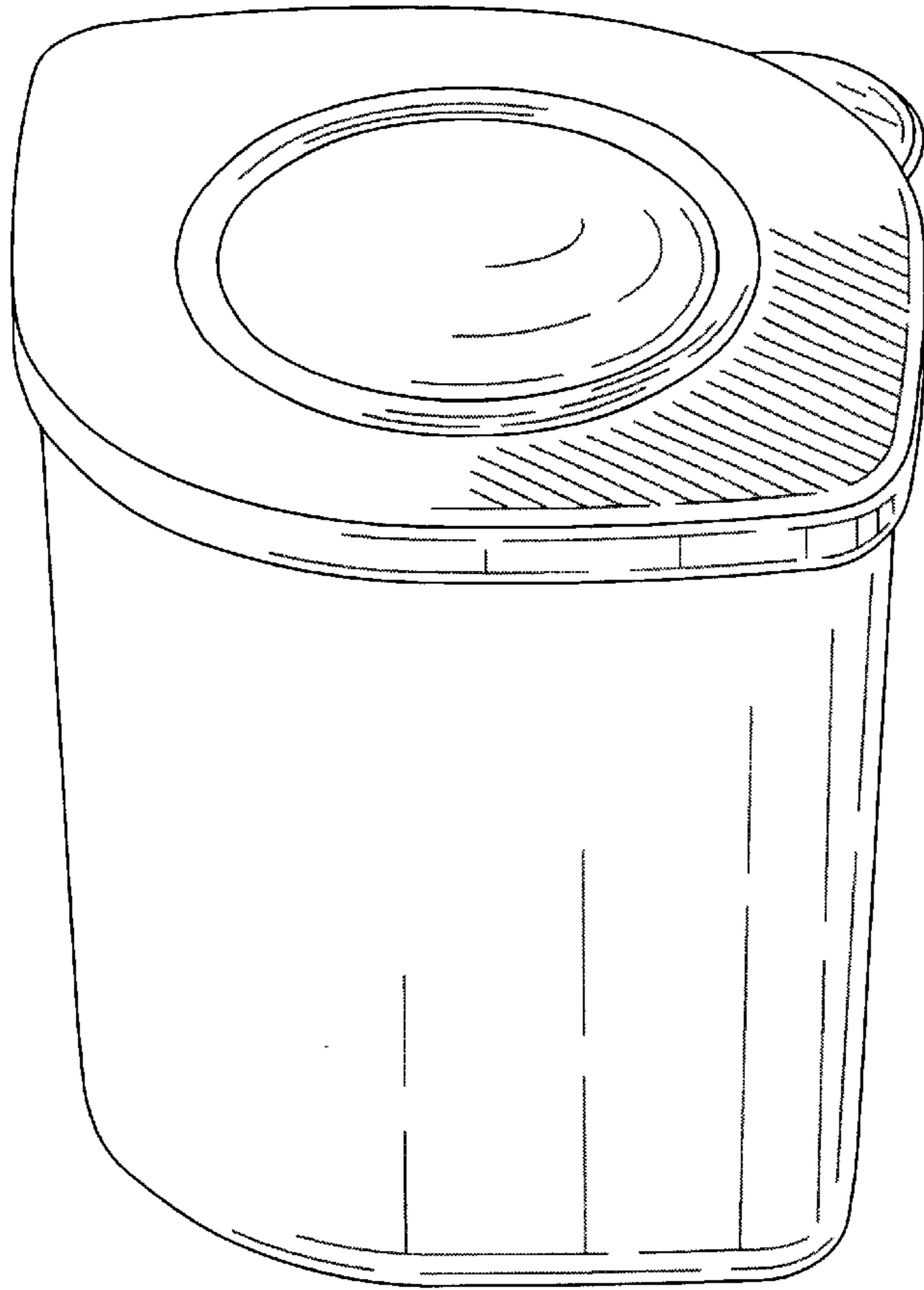

FIG. 8

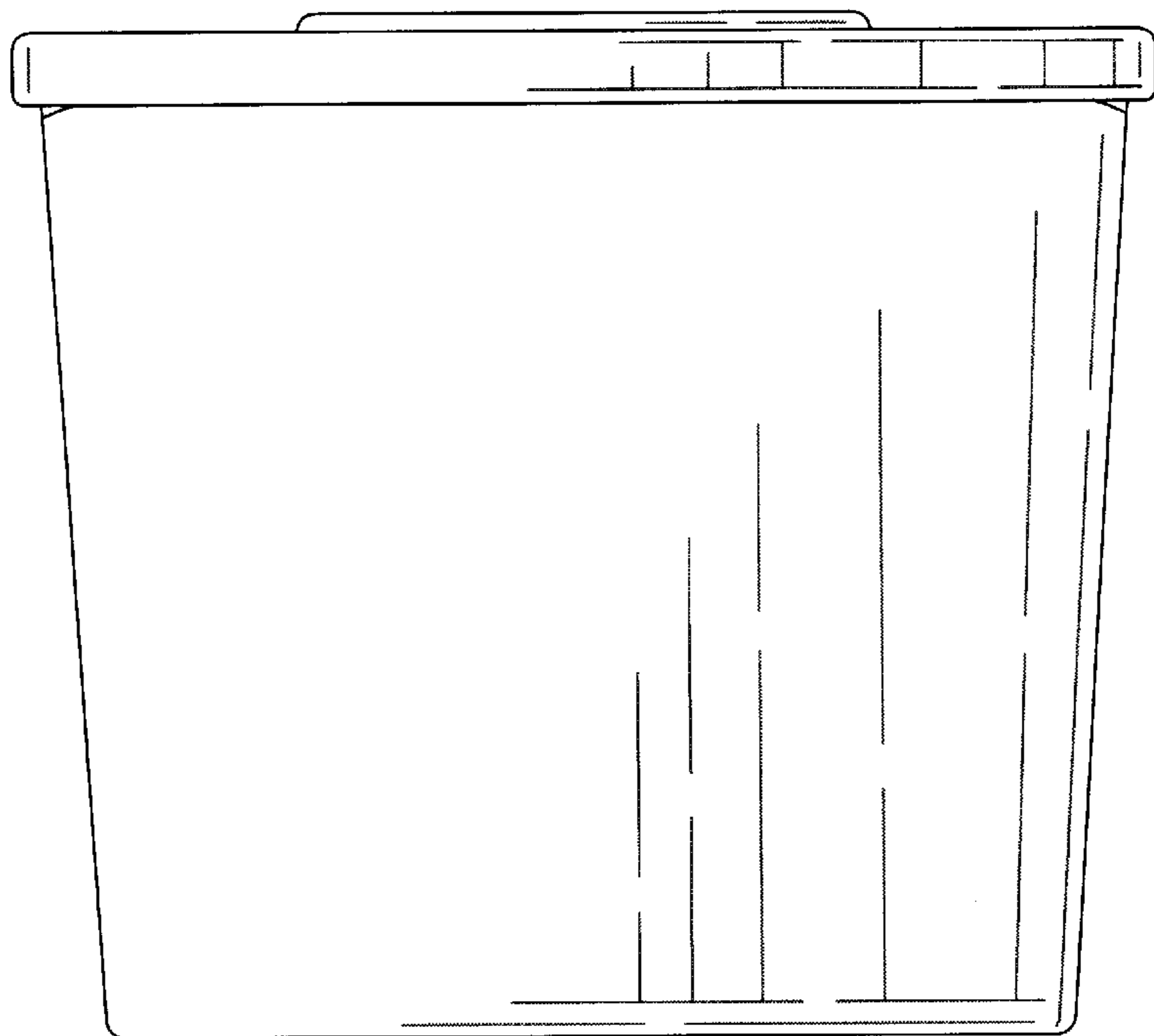

FIG. 9

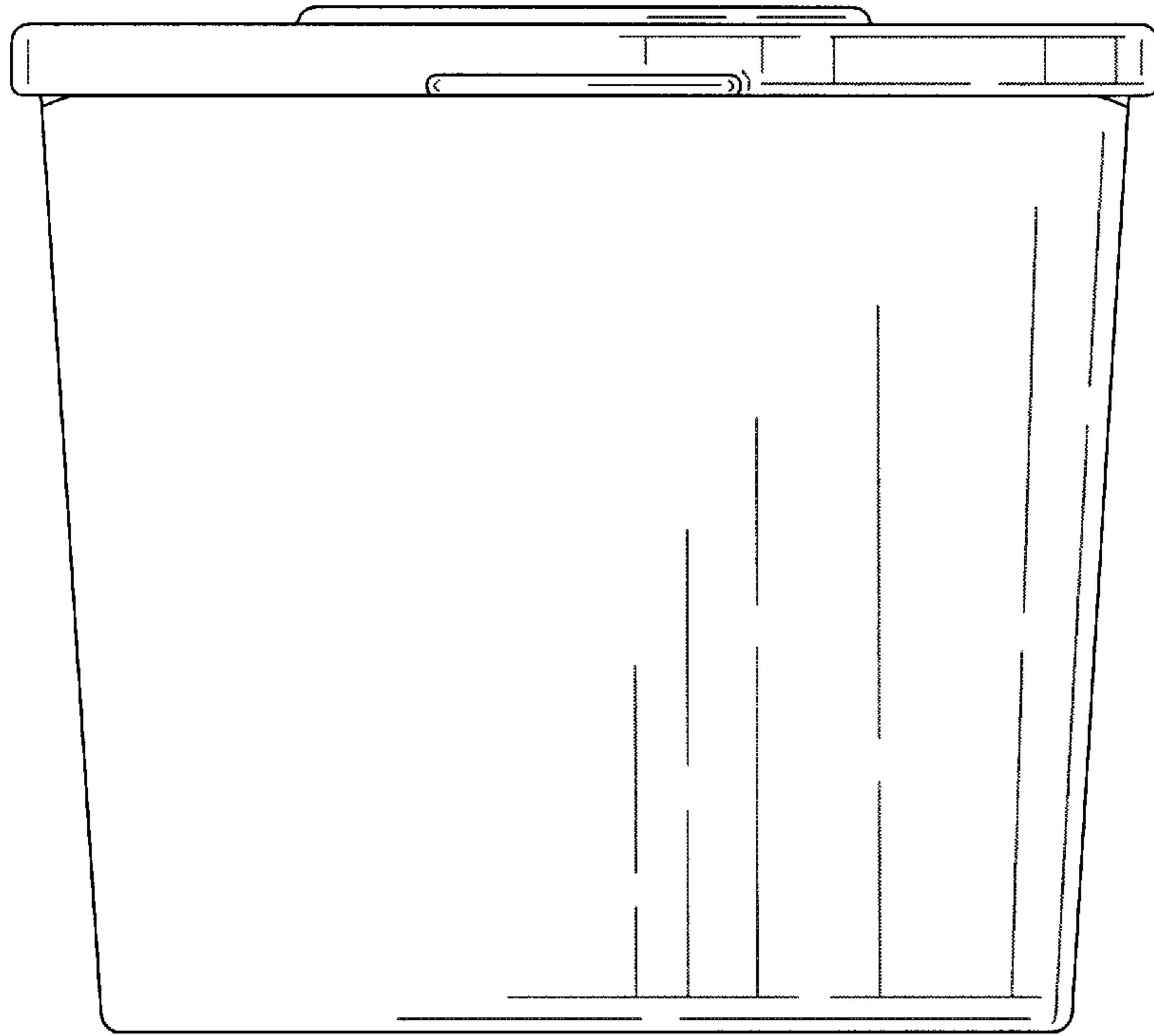

FIG. 10

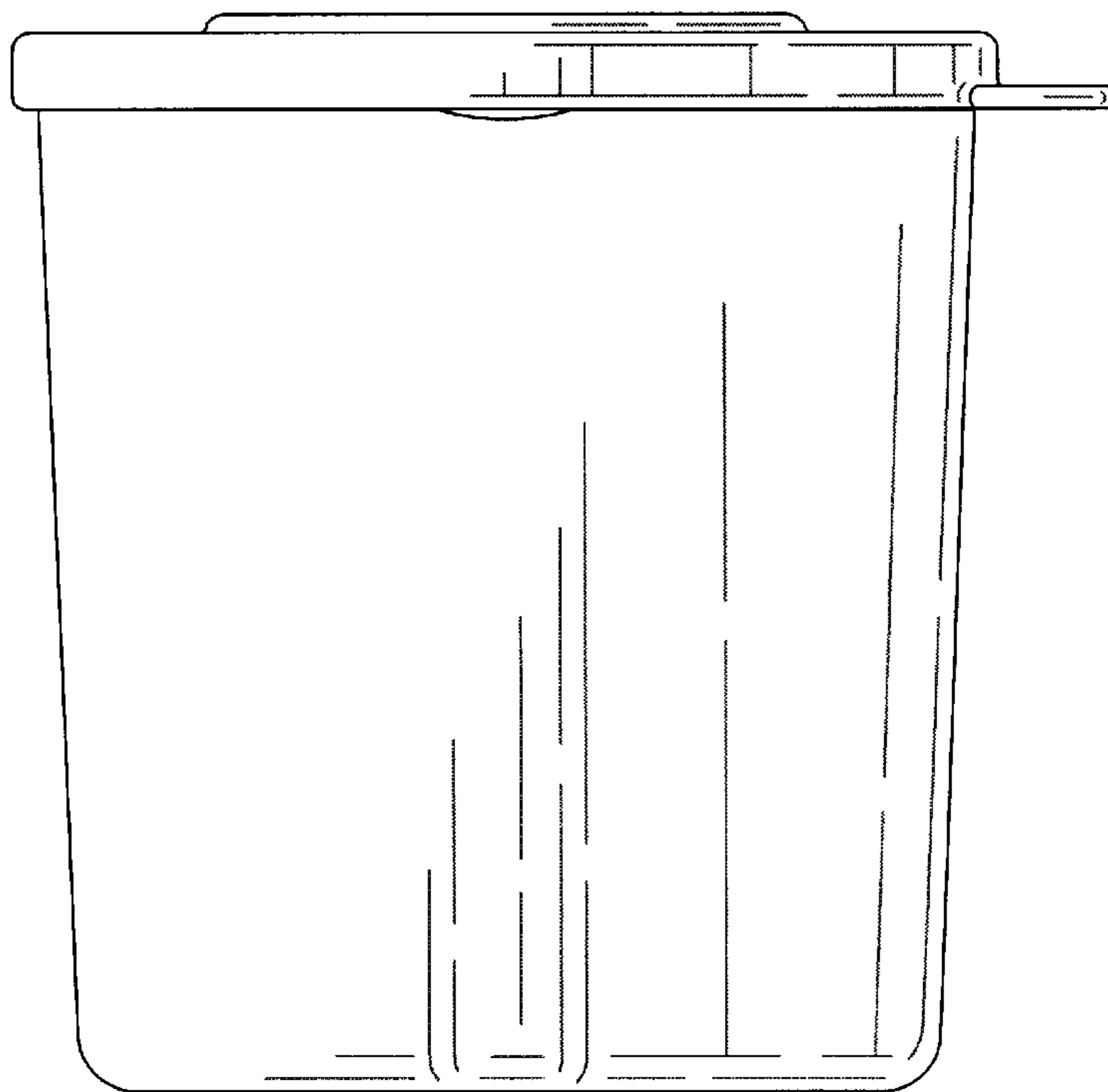

FIG. 11

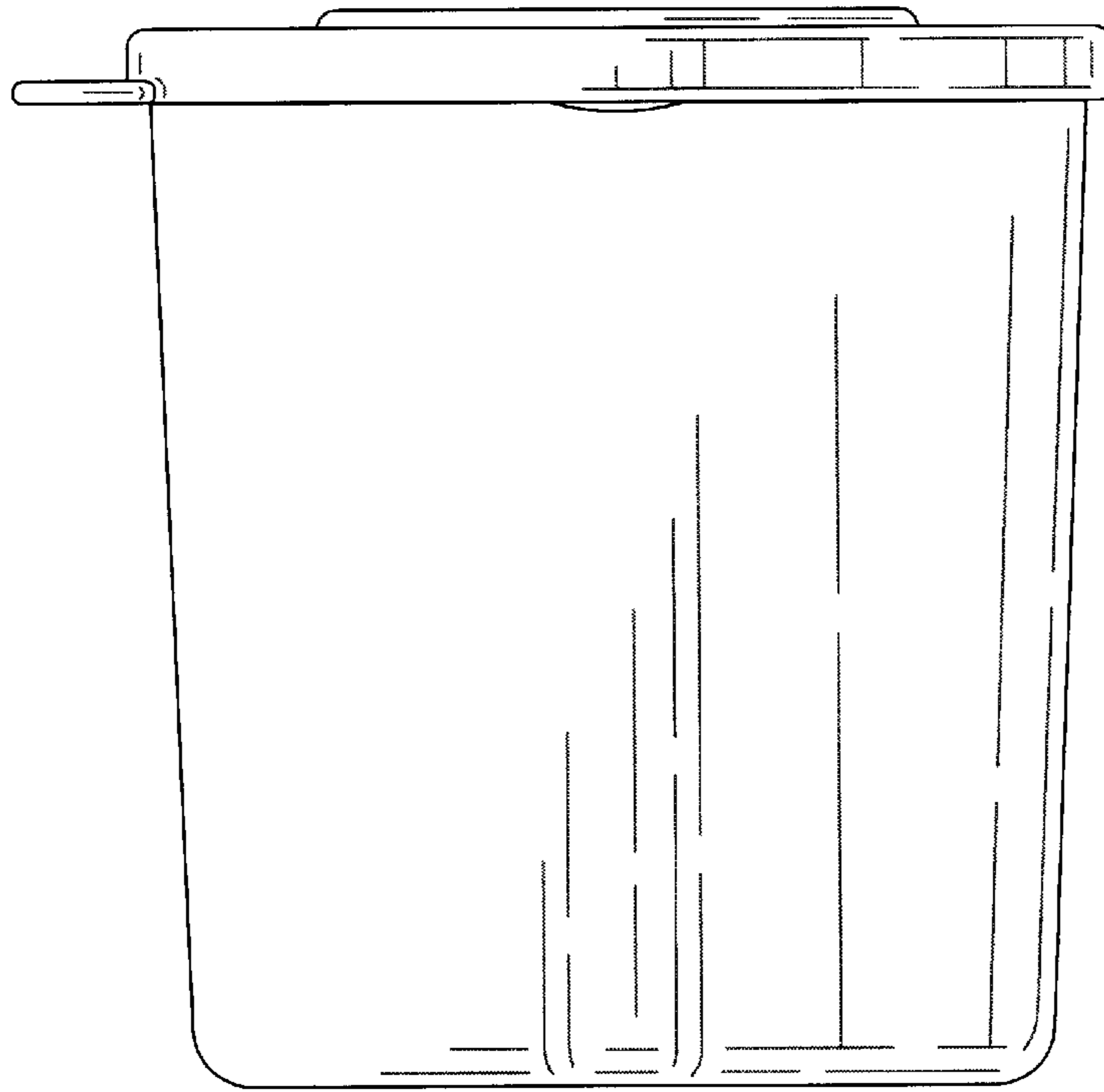

FIG. 12

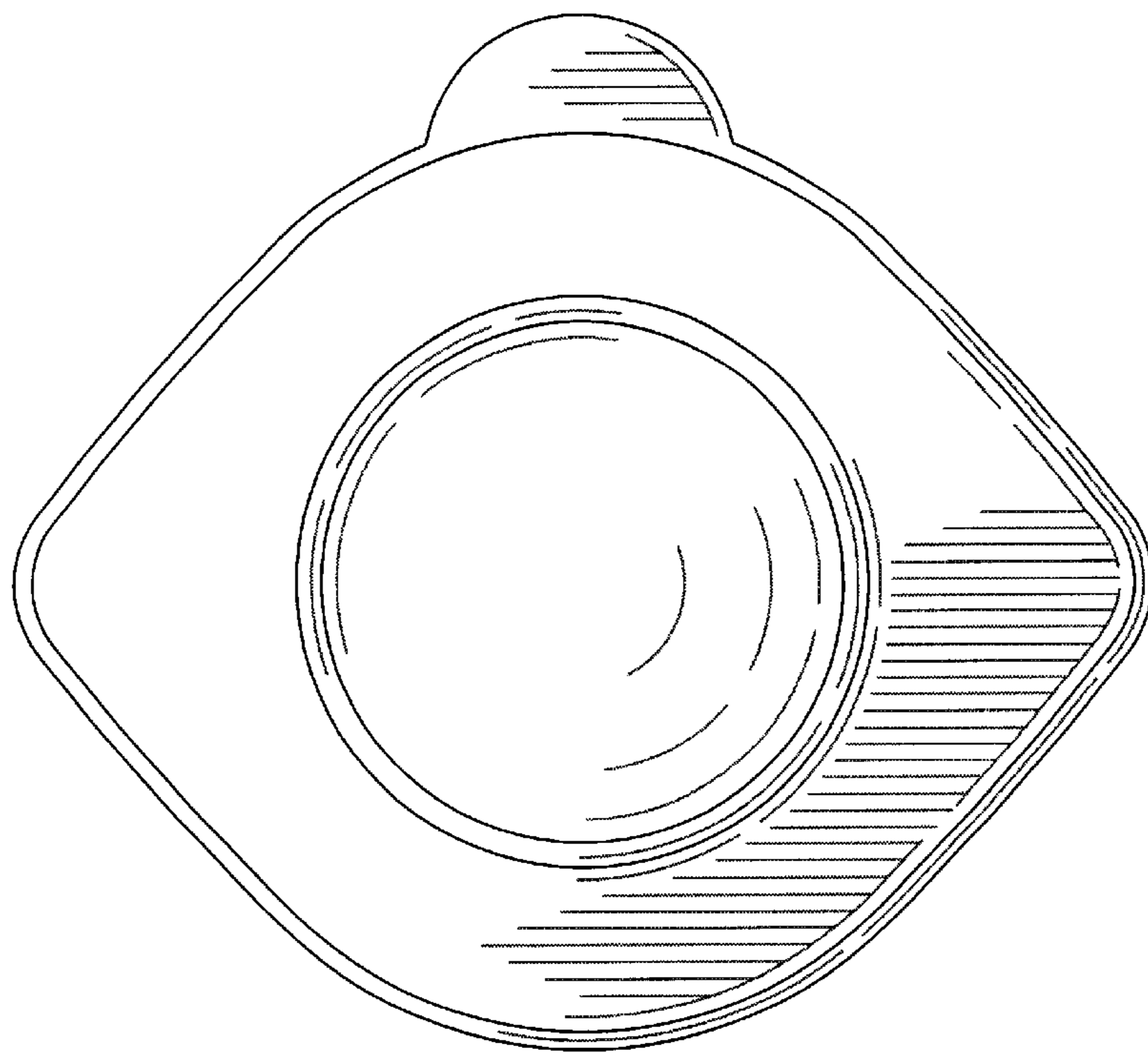

FIG. 13

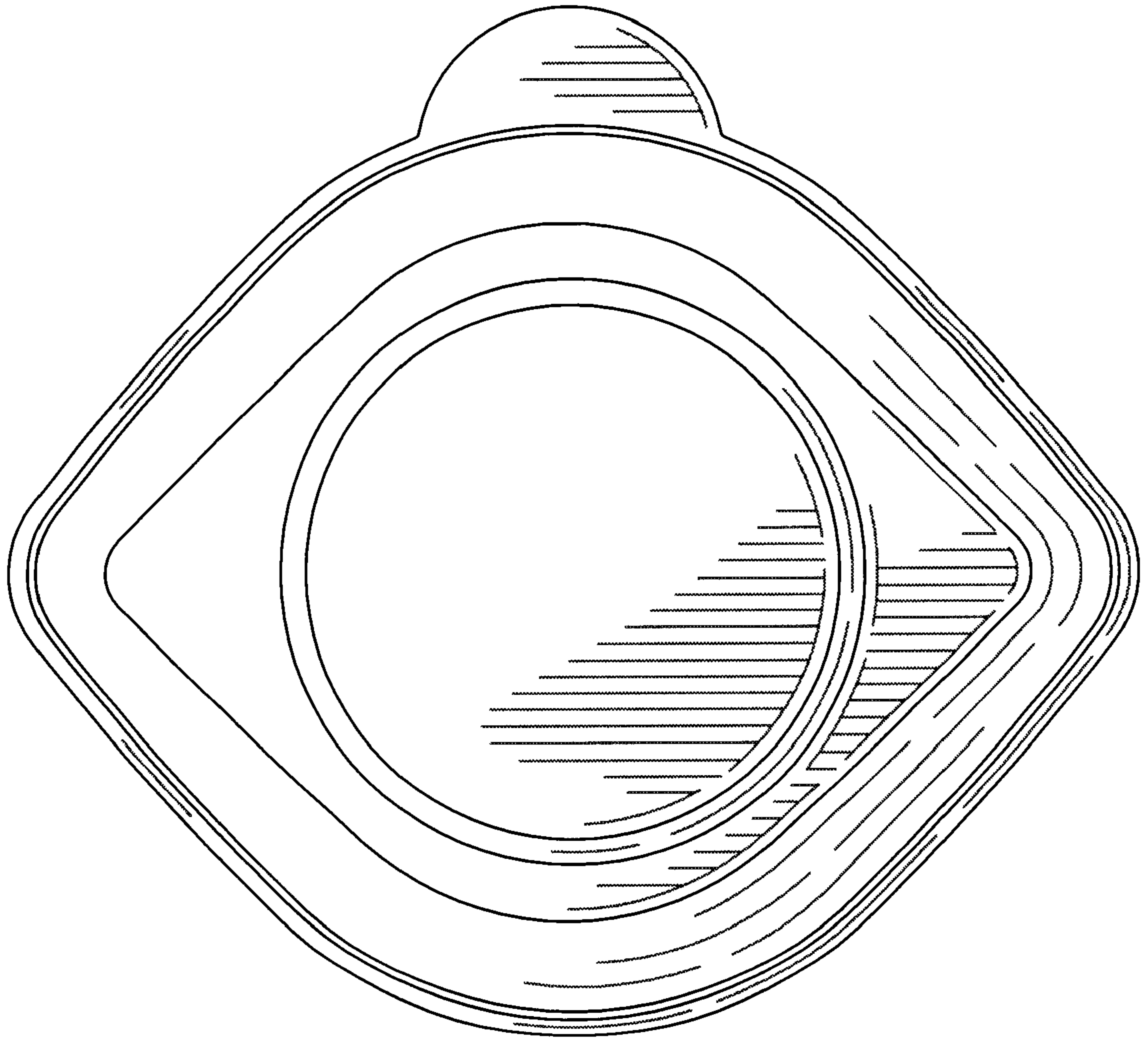

FIG. 14

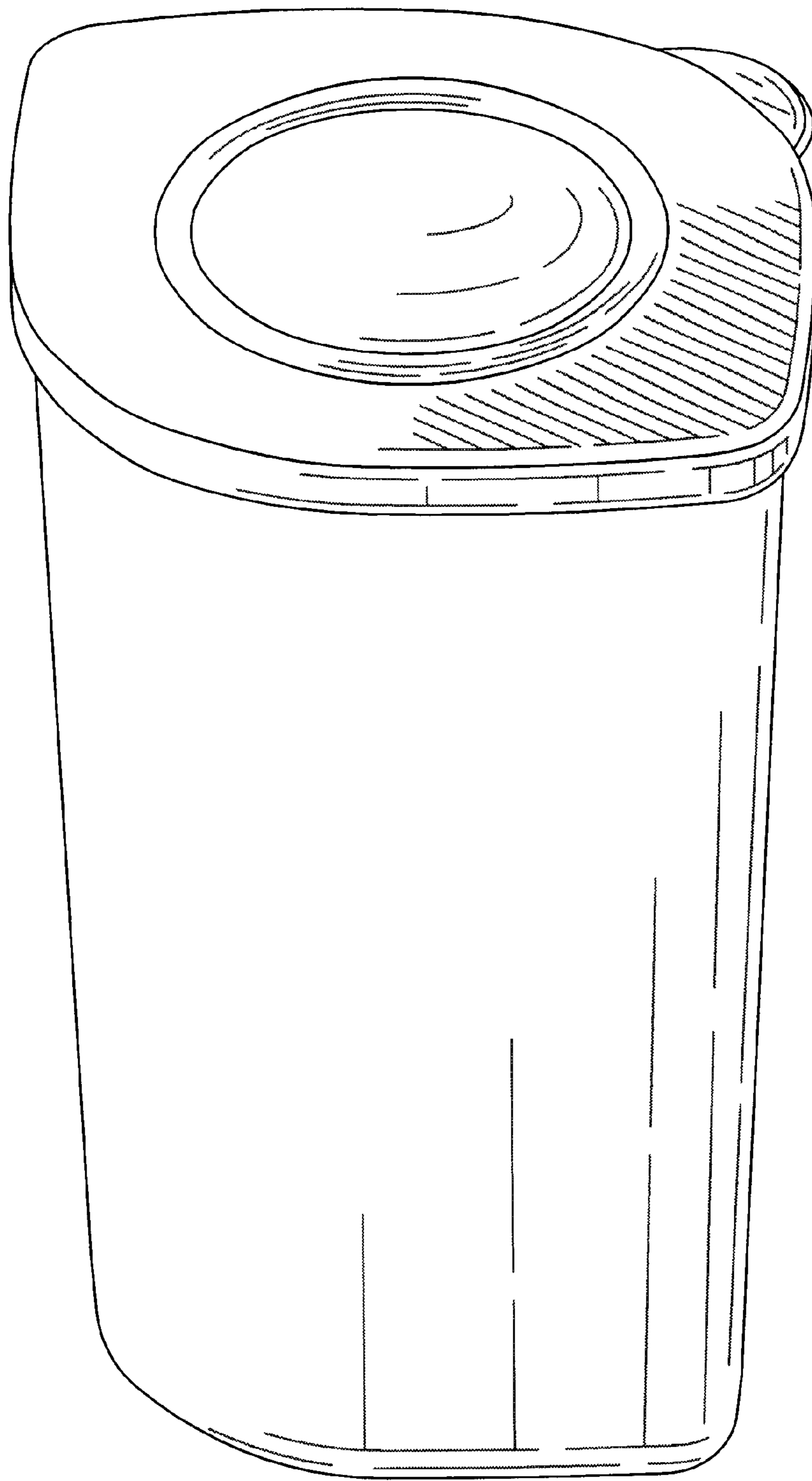

FIG. 15

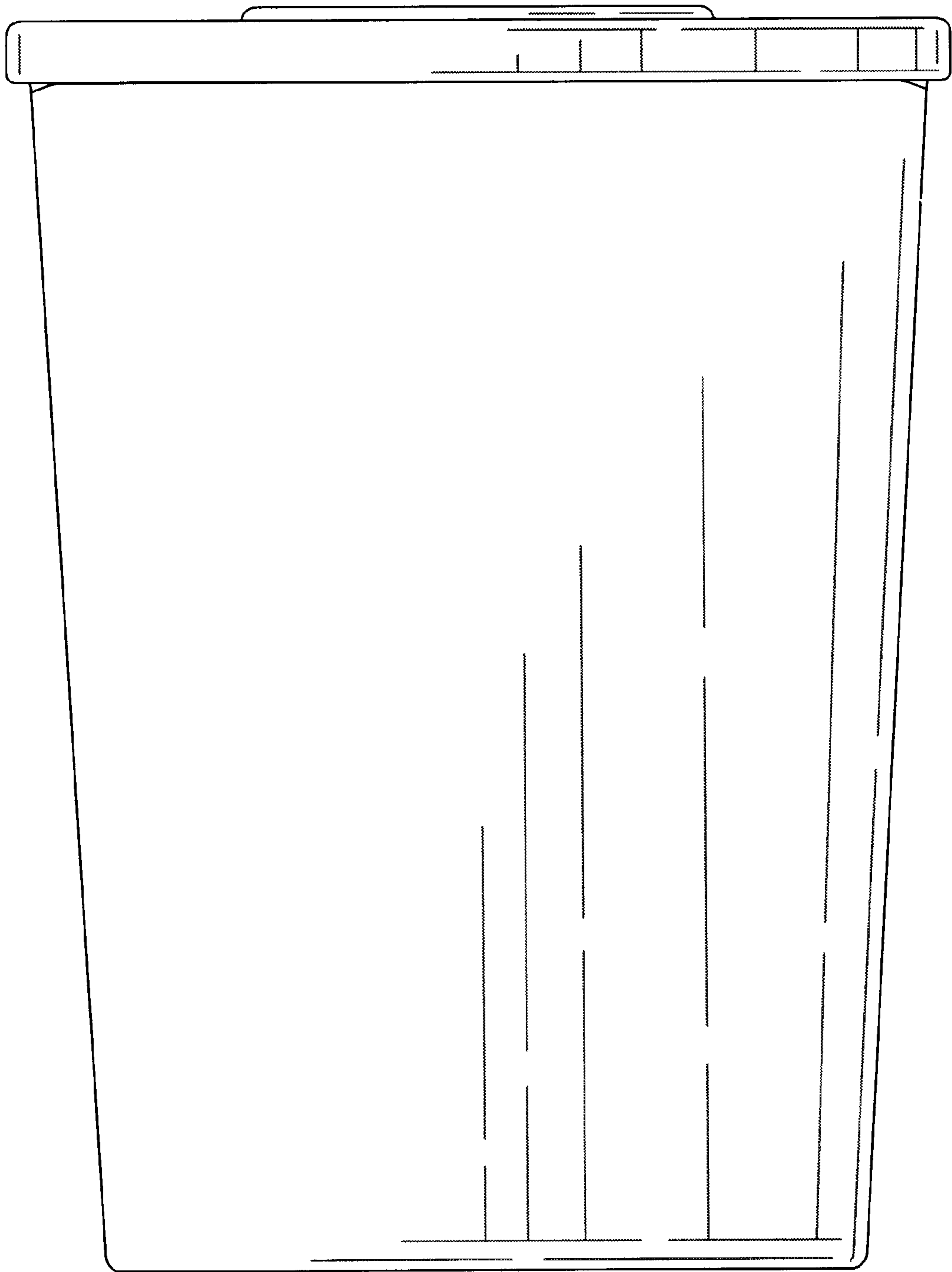

FIG. 16

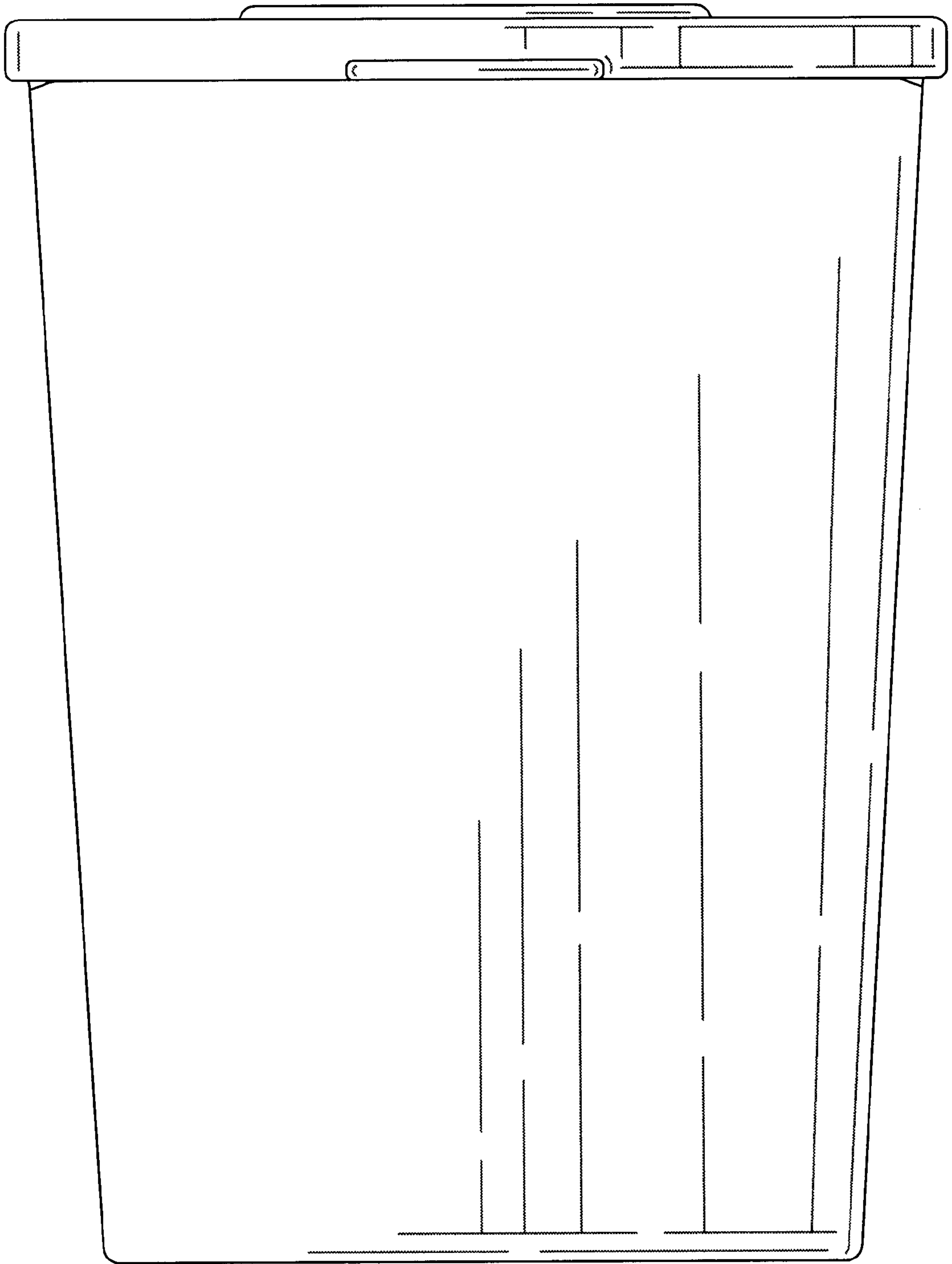

FIG. 17

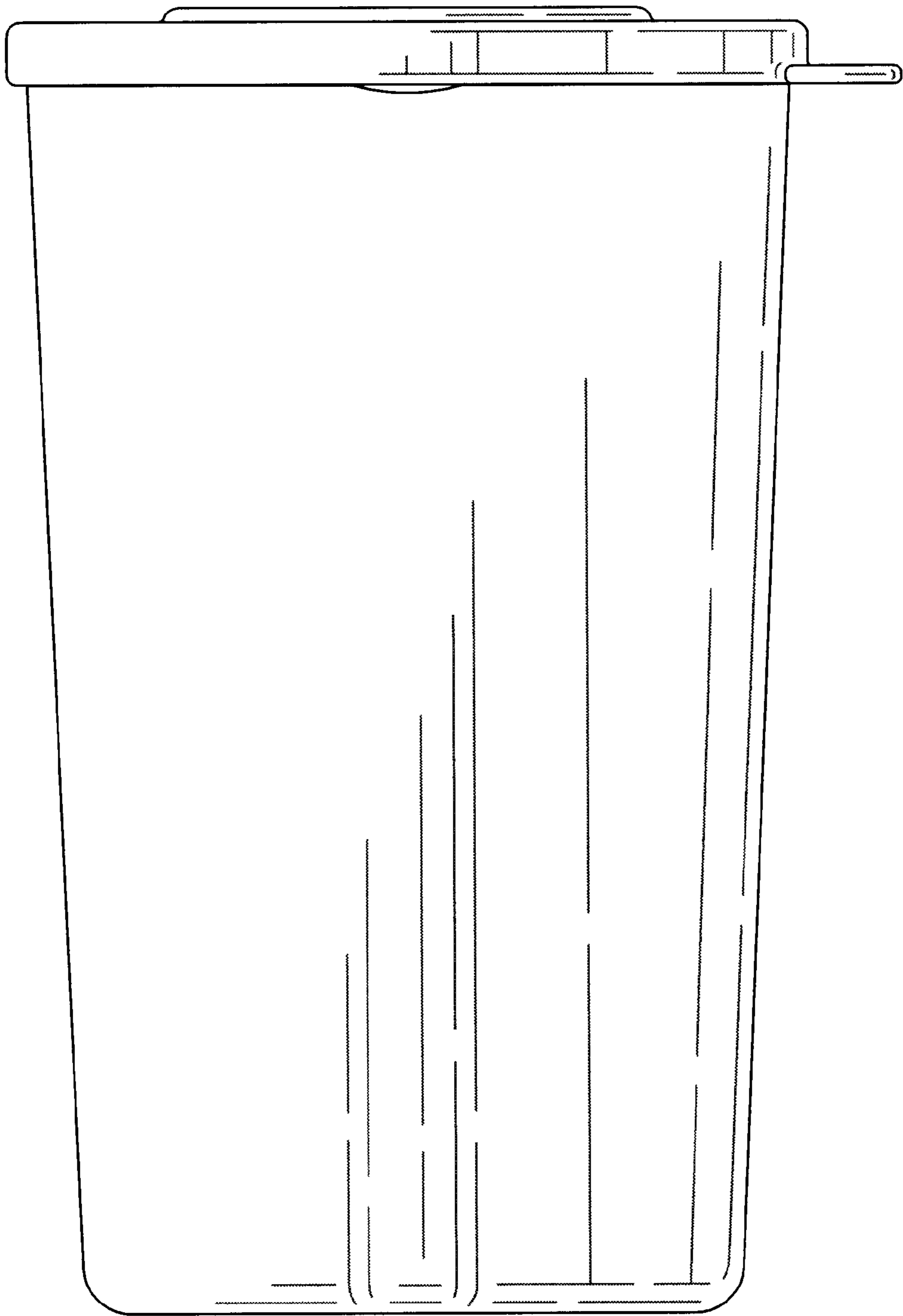

FIG. 18

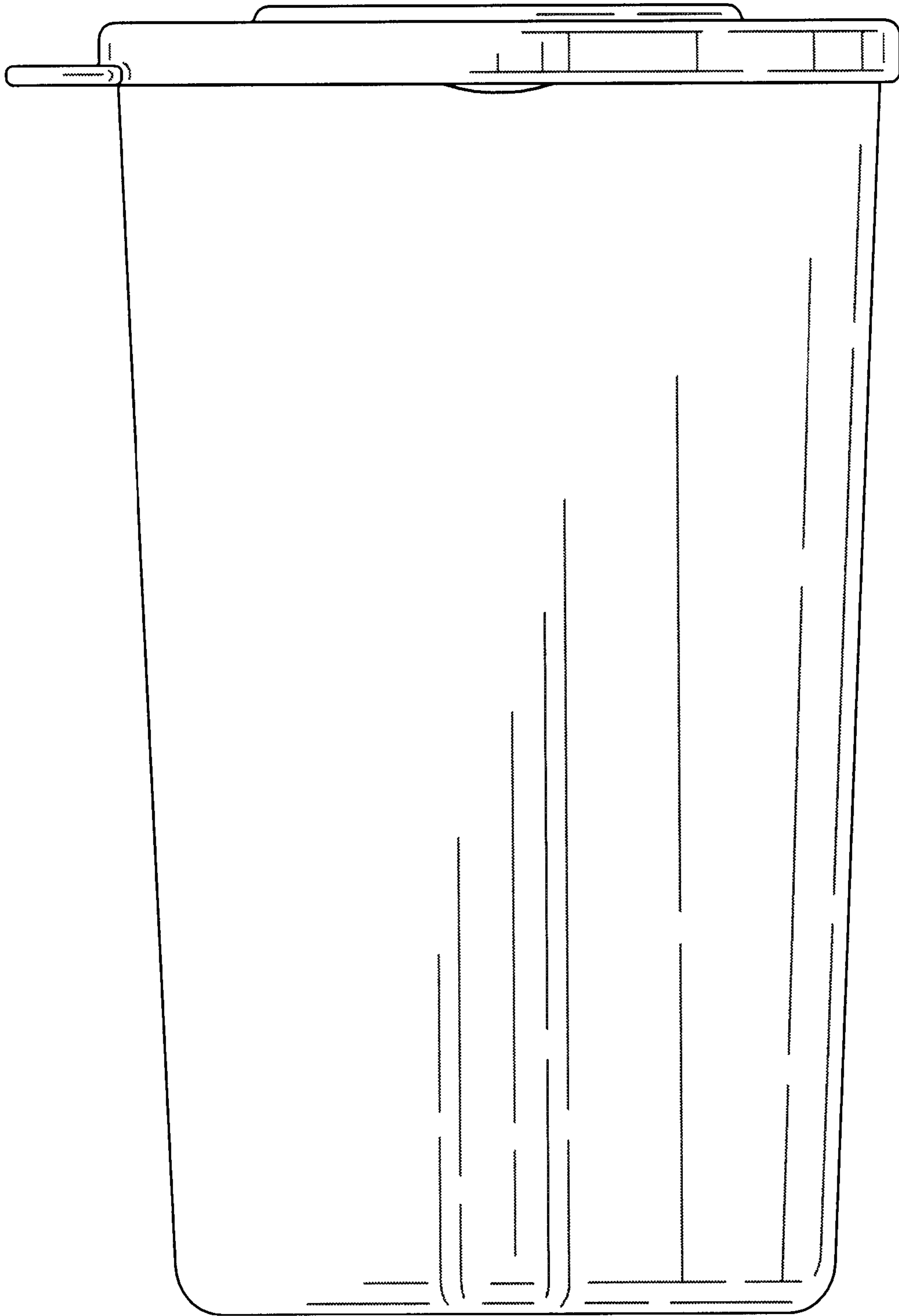

FIG. 19

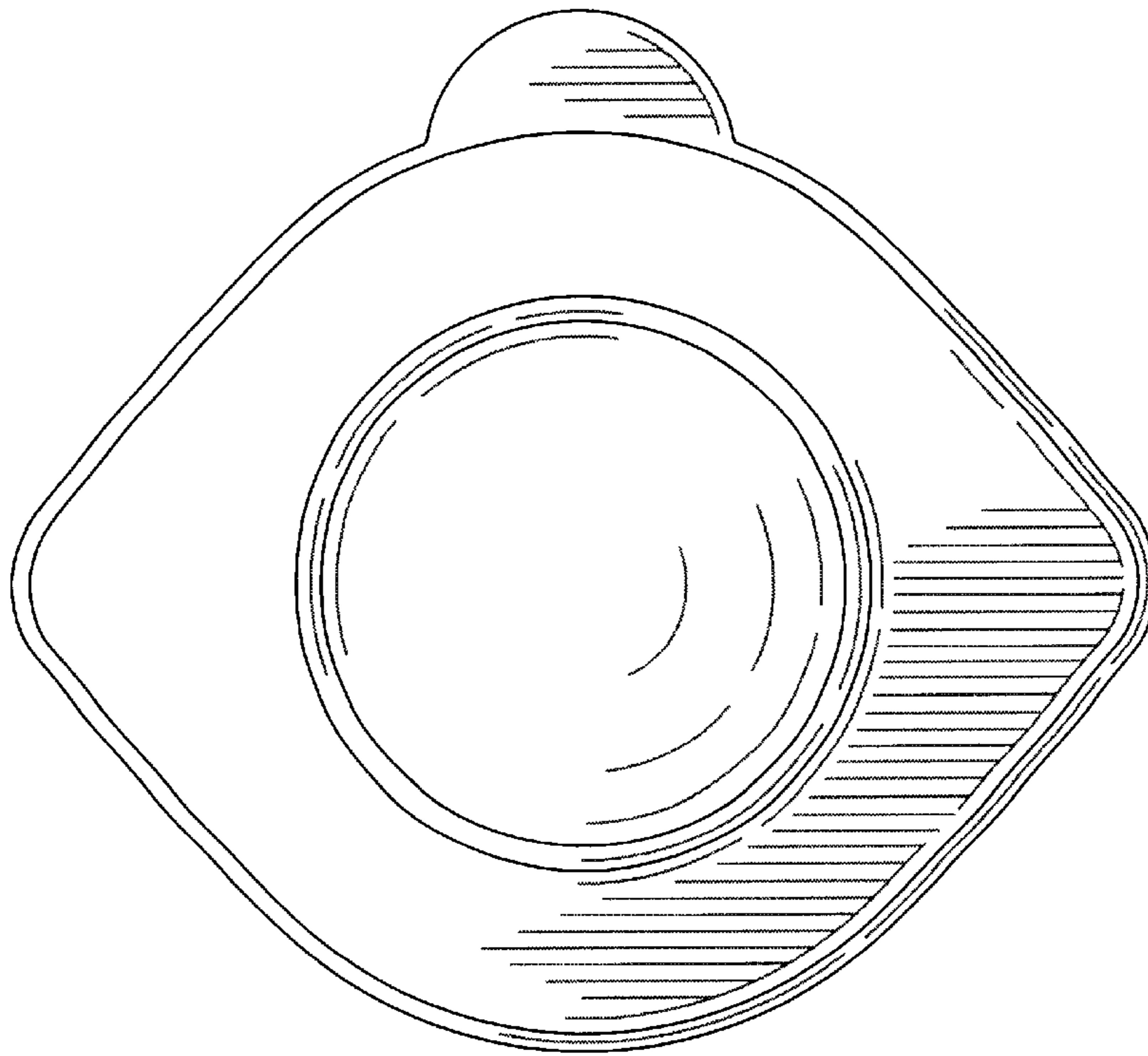

FIG. 20

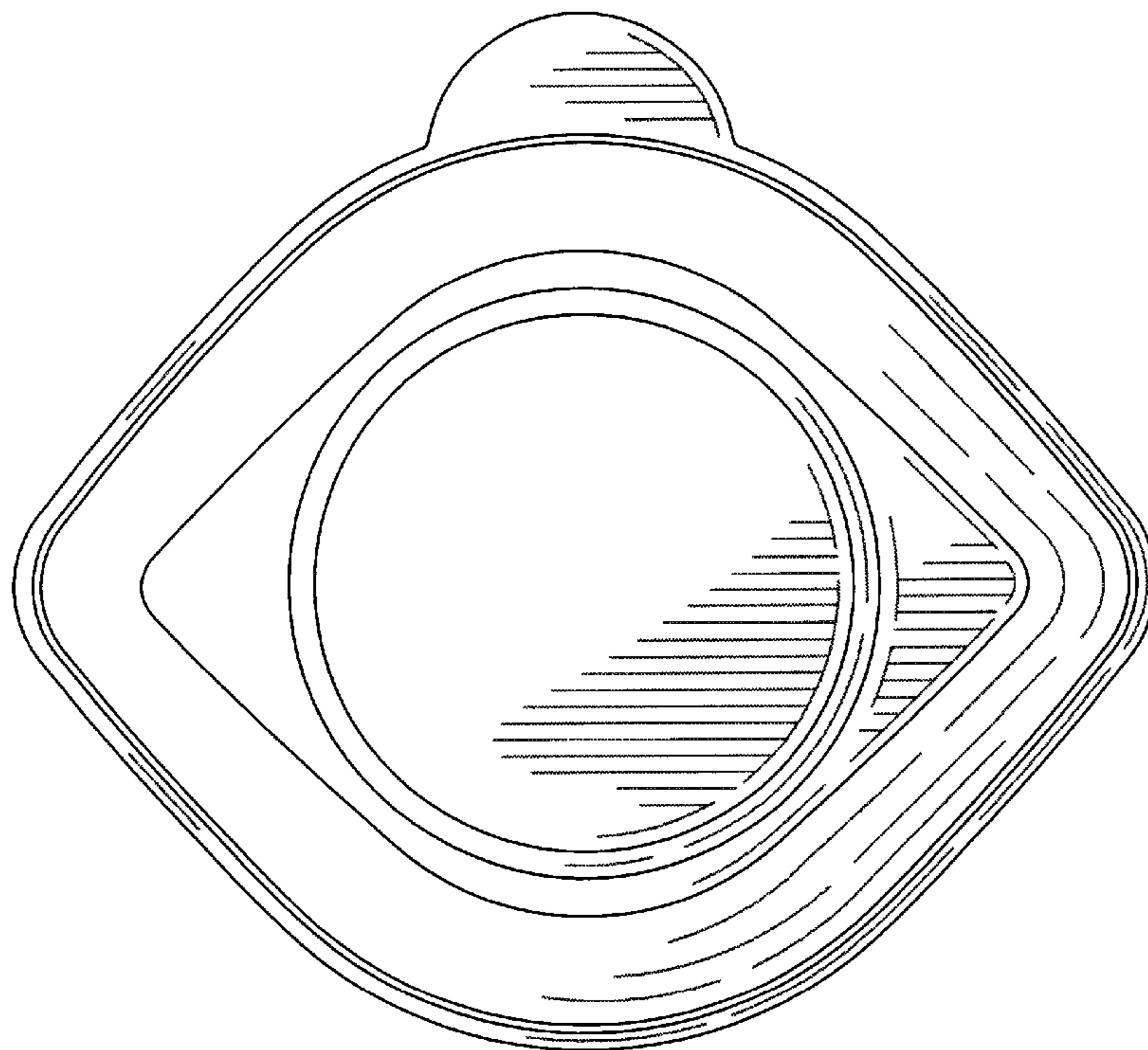

FIG. 21