



US00D483204S

(12) **United States Design Patent**
Chang

(10) **Patent No.:** **US D483,204 S**

(45) **Date of Patent:** **** Dec. 9, 2003**

(54) **BOOK HOLDER**

(76) **Inventor:** **Chun Yuan Chang**, P.O. Box 63-99,
Taichung (TW), 406

(**) **Term:** **14 Years**

(21) **Appl. No.:** **29/170,629**

(22) **Filed:** **Nov. 7, 2002**

(51) **LOC (7) Cl.** **06-04**

(52) **U.S. Cl.** **D6/475; D19/91**

(58) **Field of Search** D6/396, 397, 630,
D6/449, 465, 468, 474, 499, 476-479, 510,
511, 475; D19/91; 108/59-61, 91-93, 147.11,
158.11; 211/42, 43, 49.1, 85.26, 133.2,
134, 181.1, 182, 188, 203; 312/7.2; D3/304,
307, 315

(56) **References Cited**

U.S. PATENT DOCUMENTS

D150,378 S * 7/1948 Spence D6/474
3,042,220 A * 7/1962 Jakobsson 108/110
D278,563 S * 4/1985 Howitt D3/304

D403,895 S * 1/1999 Beggs D6/475

D427,458 S * 7/2000 McColskey et al. D6/477

6,308,839 B1 * 10/2001 Steinberg et al. 211/40

D454,737 S * 3/2002 Carrabba D6/511

D476,510 S * 7/2003 Henry et al. D6/479

* cited by examiner

Primary Examiner—Cathron C. Brooks

(57) **CLAIM**

The ornamental design for a book holder, as shown and described.

DESCRIPTION

FIG. 1 is a perspective view of a book holder showing my new design;
FIG. 2 is a front elevational view thereof;
FIG. 3 is a rear elevational view thereof;
FIG. 4 is a top plan view thereof;
FIG. 5 is a bottom plan view thereof;
FIG. 6 is a left side elevational view thereof; and,
FIG. 7 is a right side elevational view thereof.

1 Claim, 4 Drawing Sheets

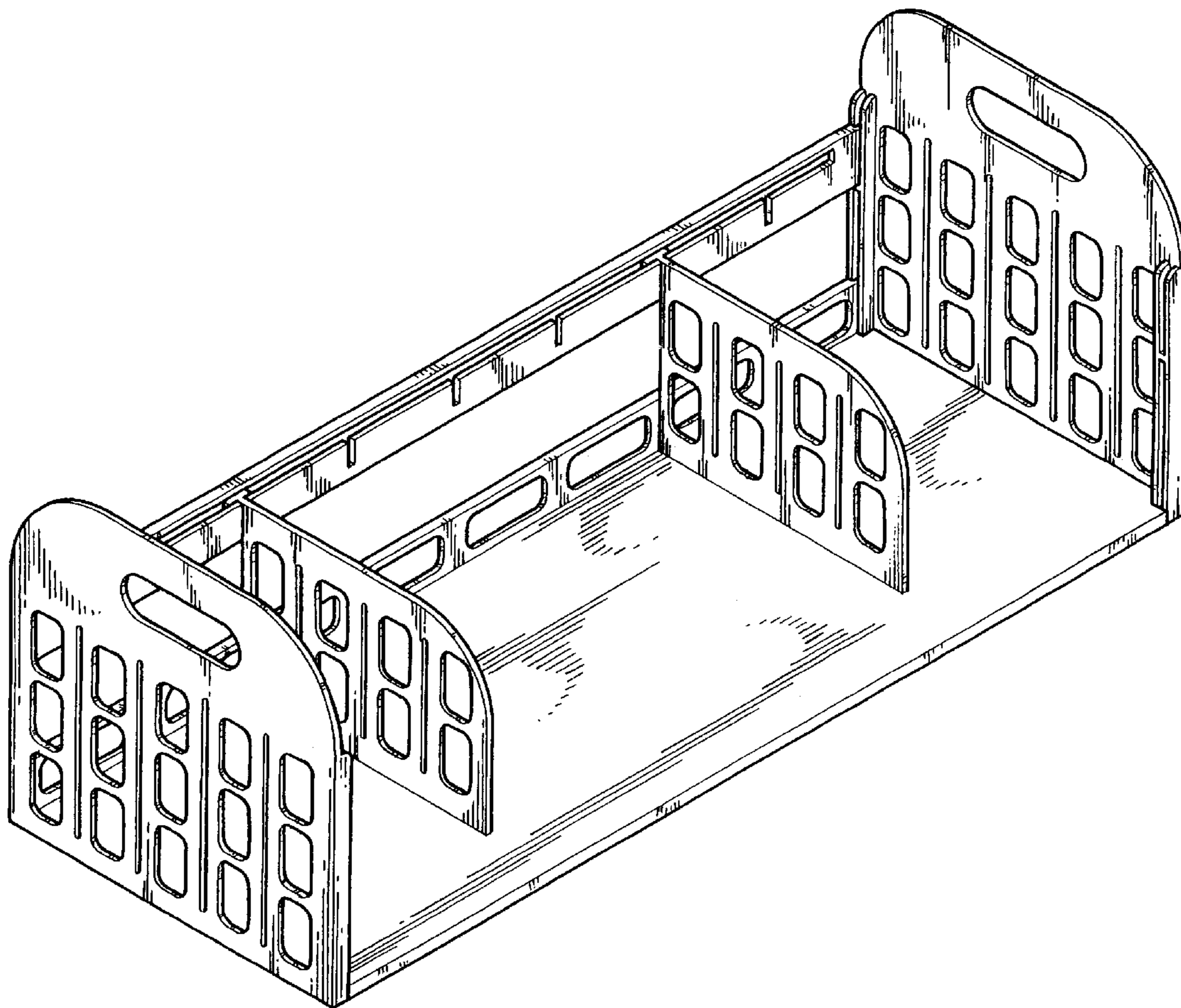

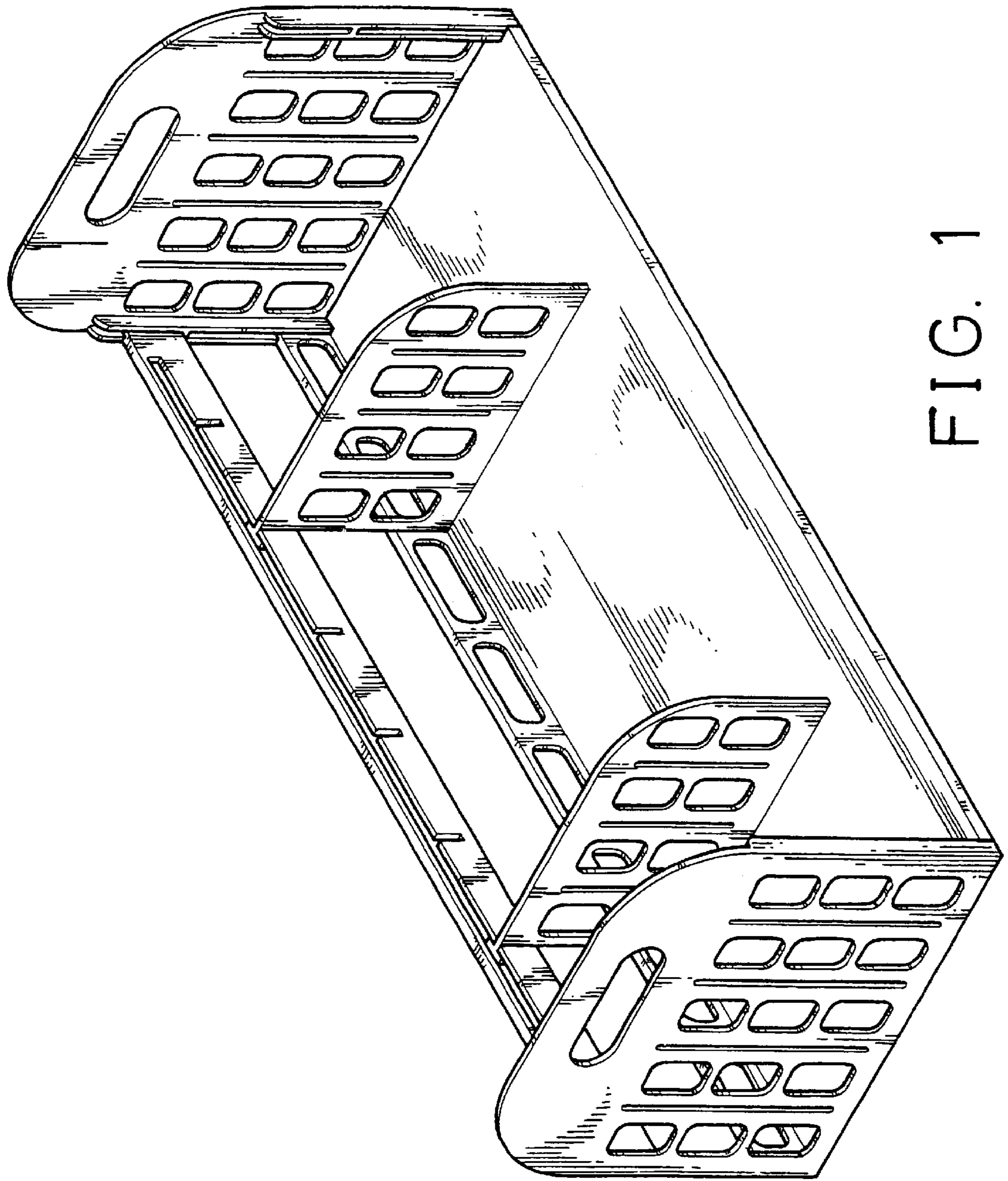

FIG. 1

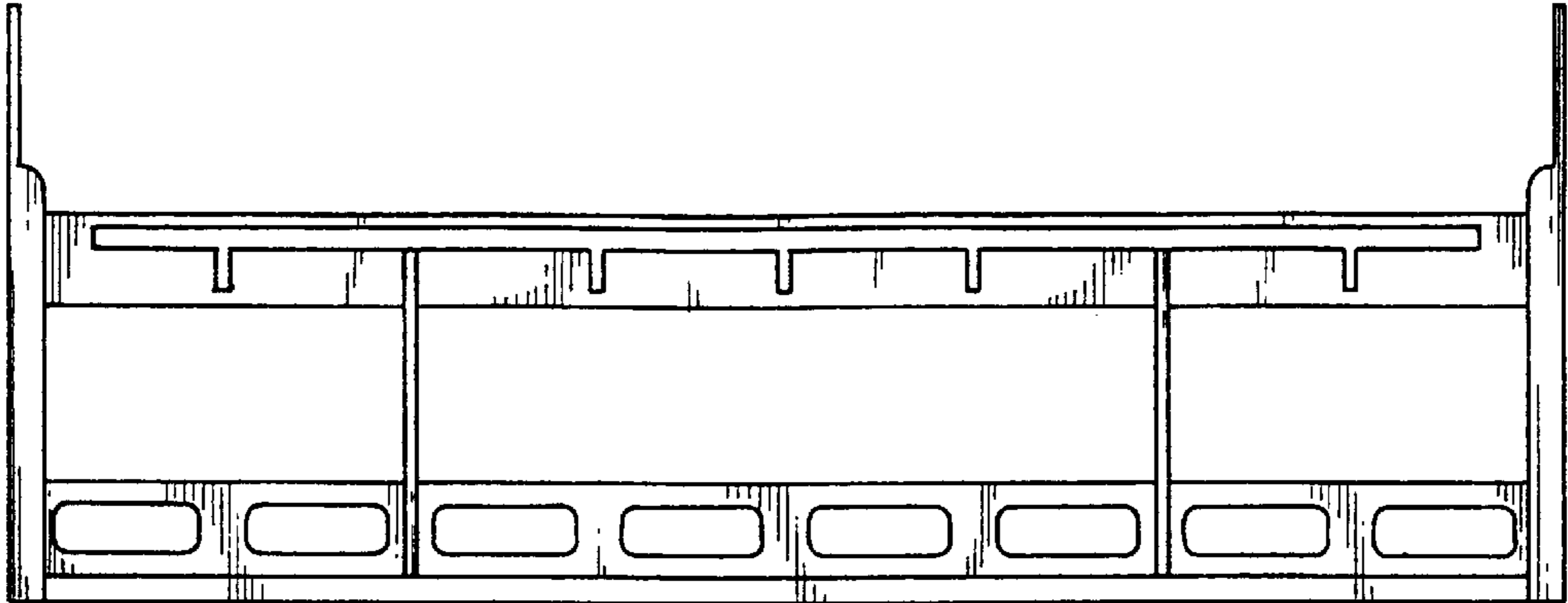

FIG. 2

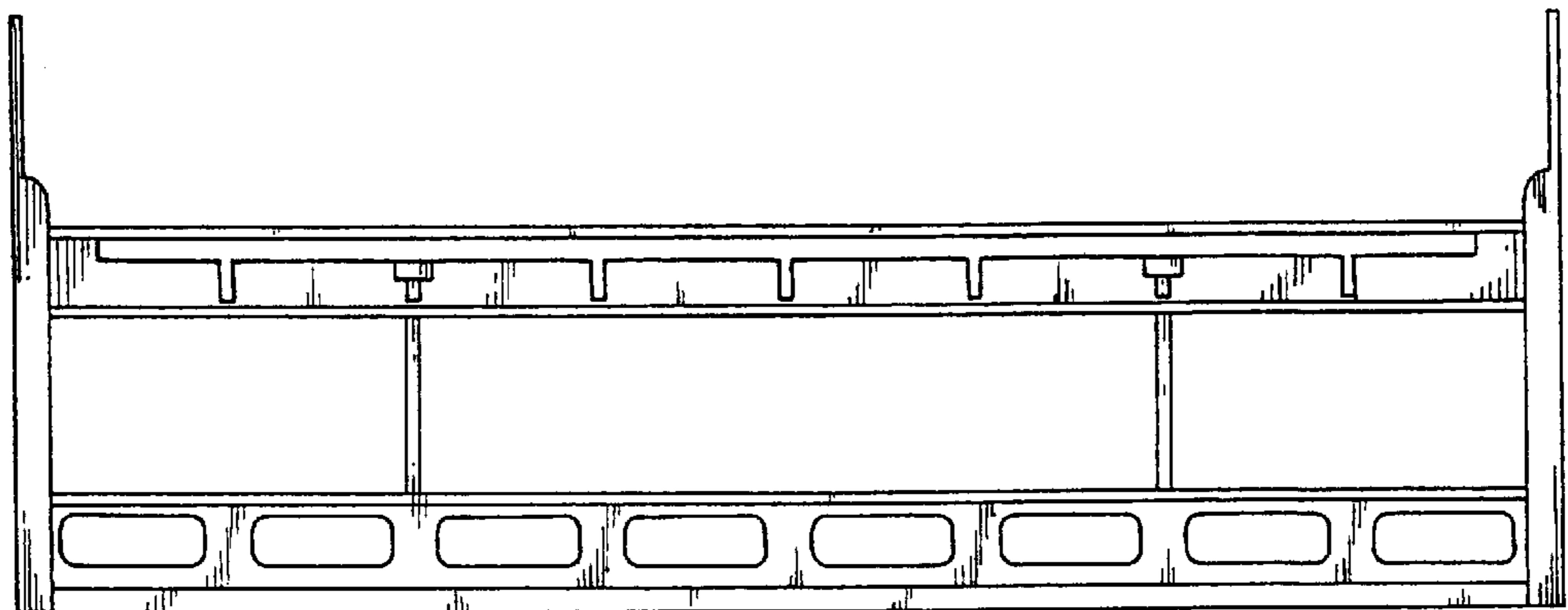

FIG. 3

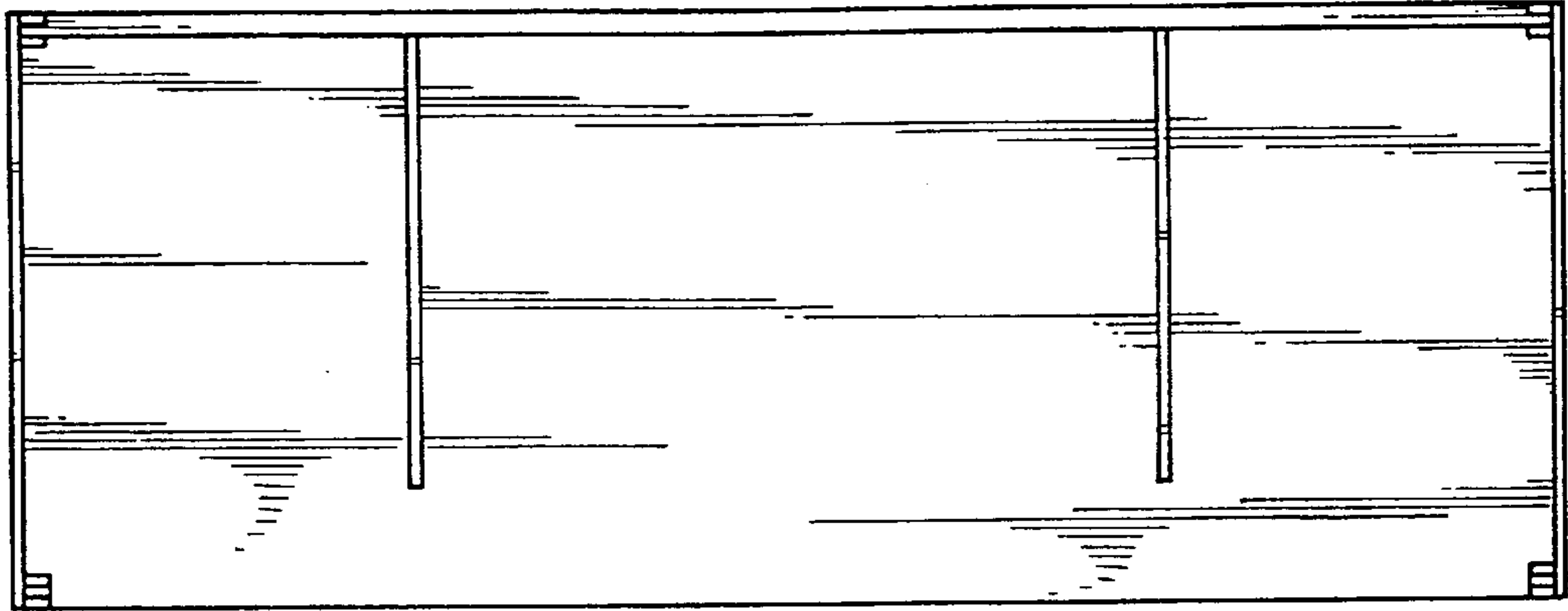

FIG. 4

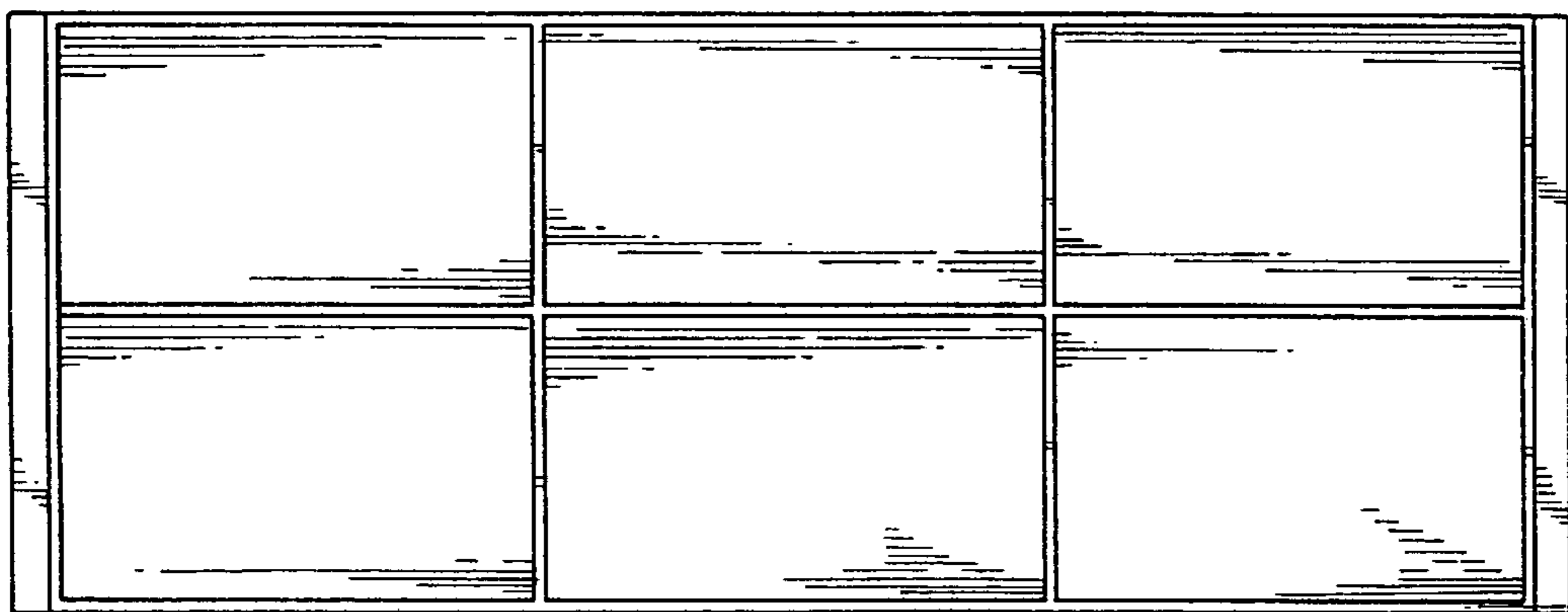

FIG. 5

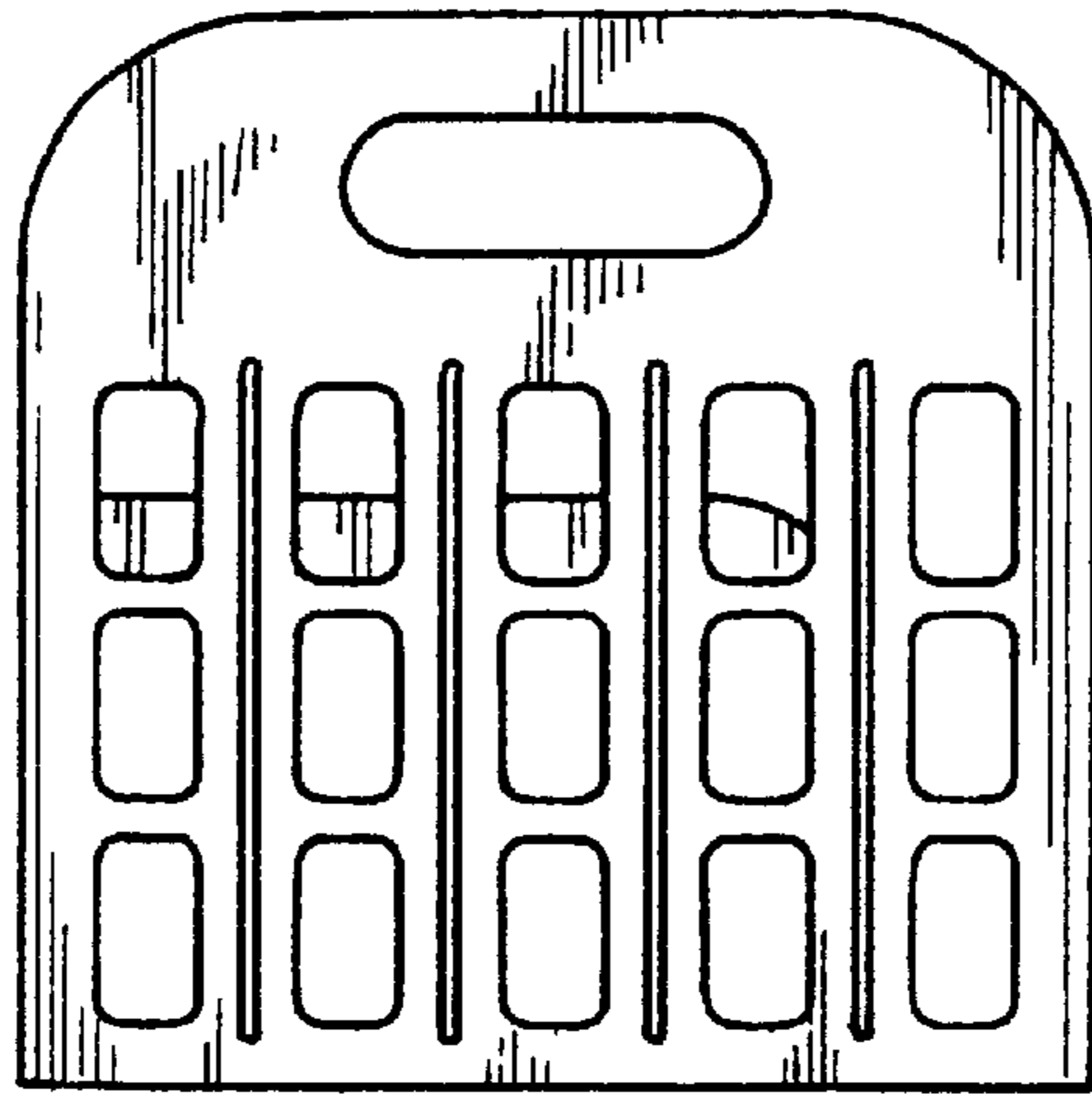

FIG. 6

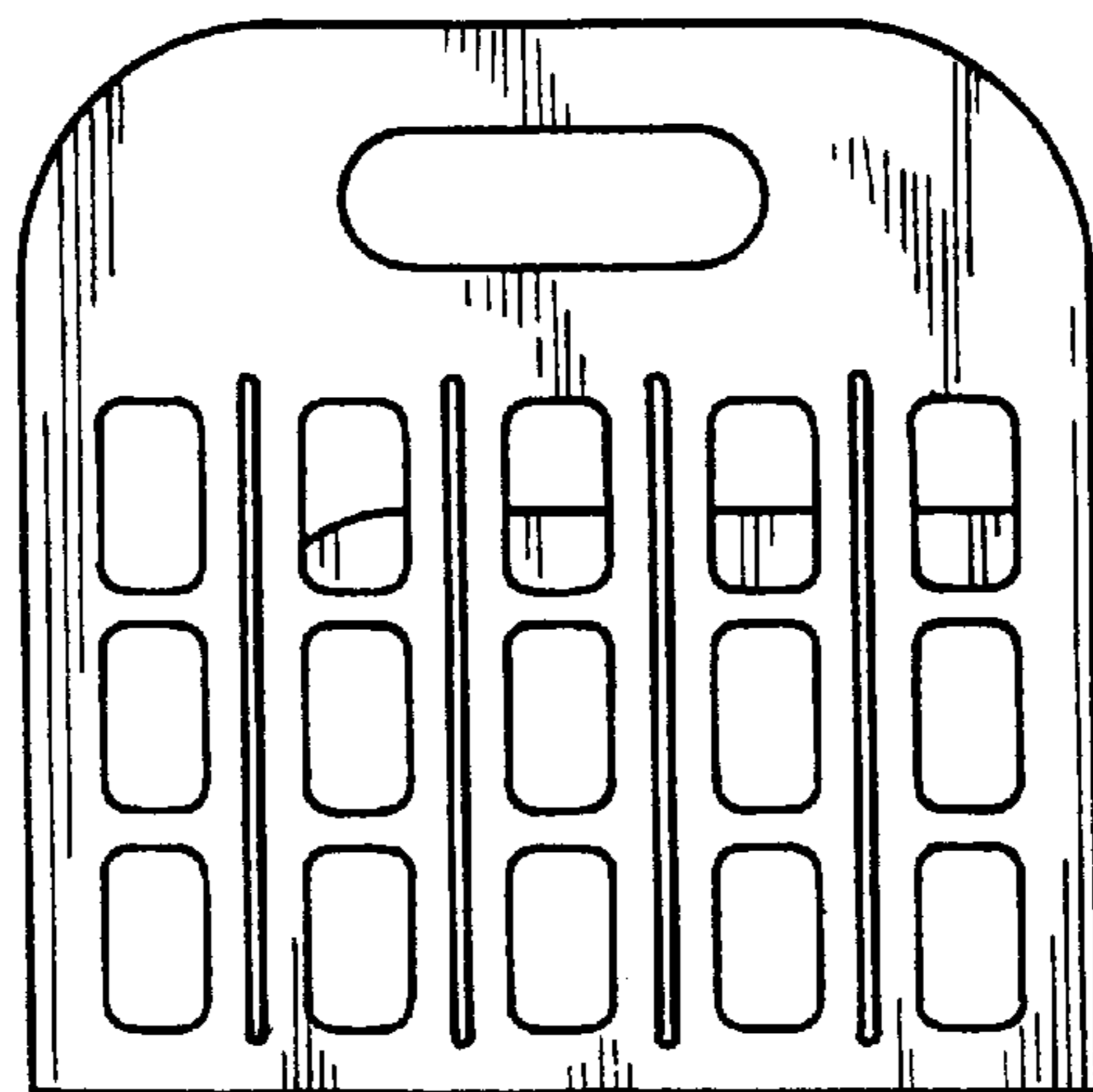

FIG. 7