



US00D483165S

(12) **United States Design Patent**
Dretzka

(10) **Patent No.:** **US D483,165 S**

(45) **Date of Patent:** **** Dec. 2, 2003**

(54) **RECEPTACLE**

(75) Inventor: **Philip C. Dretzka**, Cleveland Heights, OH (US)

(73) Assignee: **InterDesign, Inc.**, Solon, OH (US)

(**) Term: **14 Years**

(21) Appl. No.: **29/166,059**

(22) Filed: **Aug. 21, 2002**

(51) **LOC (7) Cl.** **09-09**

(52) **U.S. Cl.** **D34/7**

(58) **Field of Search** D34/1, 4, 5, 6,
D34/7, 8, 9, 10, 11; 220/908, 908.1, 909,
910, 911, 913

(56) **References Cited**

U.S. PATENT DOCUMENTS

D418,957 S	*	1/2000	Rashid	D34/7
D453,600 S	*	2/2002	Lin	D34/9
D457,389 S		5/2002	Snell		
D457,702 S	*	5/2002	Tropper et al.	D34/1
D457,782 S		5/2002	Snell		
D461,940 S	*	8/2002	Meinzinger et al.	D34/7
D463,715 S		10/2002	Dretzka		

D472,686 S	*	4/2003	Lin	D34/7
D472,687 S	*	4/2003	Lin	D34/7
D473,360 S	*	4/2003	Ffuller	D34/7

* cited by examiner

Primary Examiner—Cynthia E. Ramirez

(74) *Attorney, Agent, or Firm*—D. Peter Hochberg; Katherine R. Vieyra; Sean Mellino

(57) **CLAIM**

The ornamental design for a receptacle, as shown and described.

DESCRIPTION

FIG. 1 is a perspective view of a receptacle according to the invention;

FIG. 2 is a top view of the receptacle as shown in FIG. 1;

FIG. 3 is a front view of the receptacle as shown in FIG. 1;

FIG. 4 is a side view of the receptacle as shown in FIG. 1;

FIG. 5 is a rear view of the receptacle as shown in FIG. 1;

FIG. 6 is a side view of the receptacle as shown in FIG. 1,

viewed from the opposite side from that shown in FIG. 4;

and,

FIG. 7 is a bottom view of the receptacle shown in FIG. 1.

1 Claim, 3 Drawing Sheets

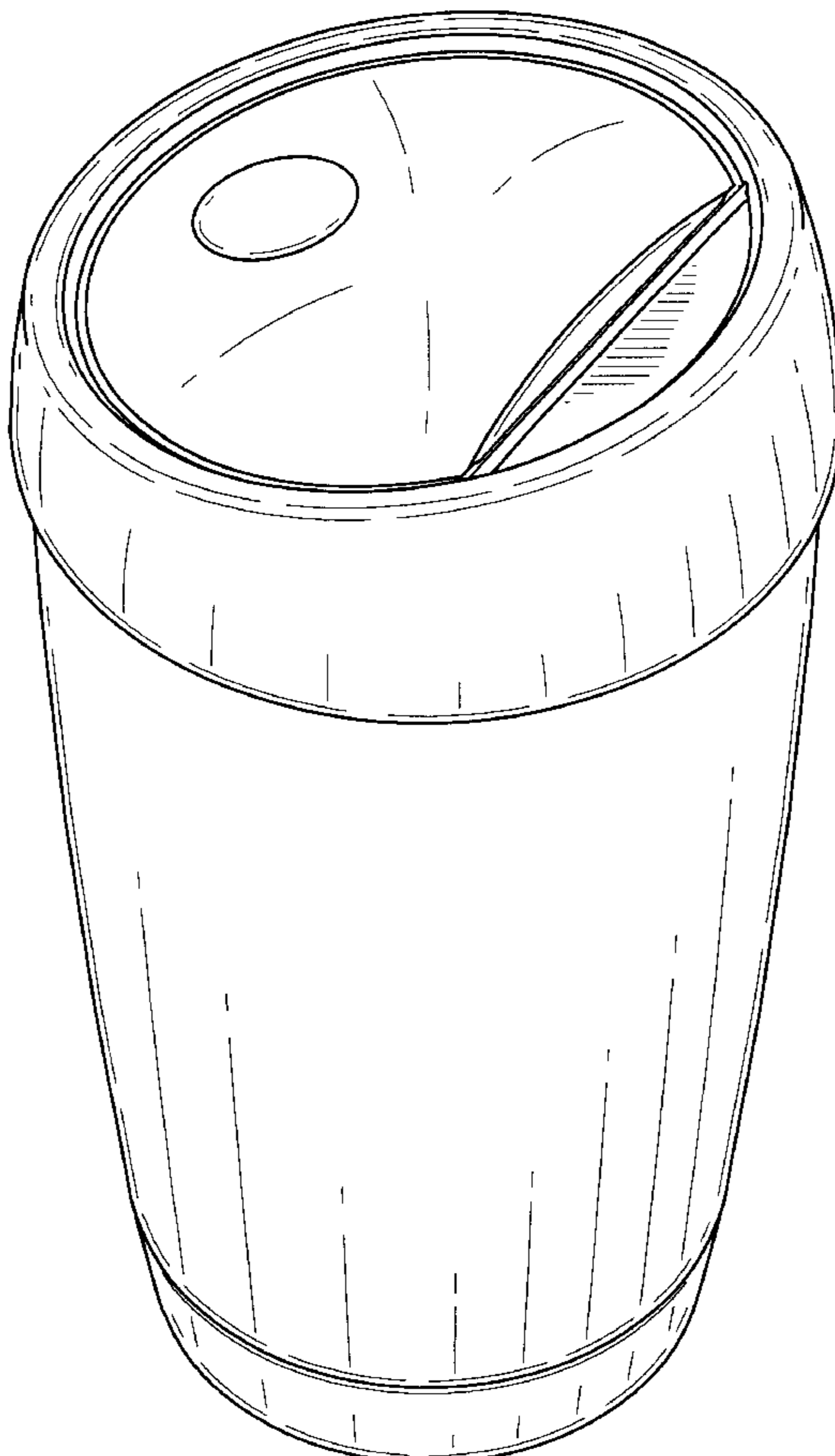

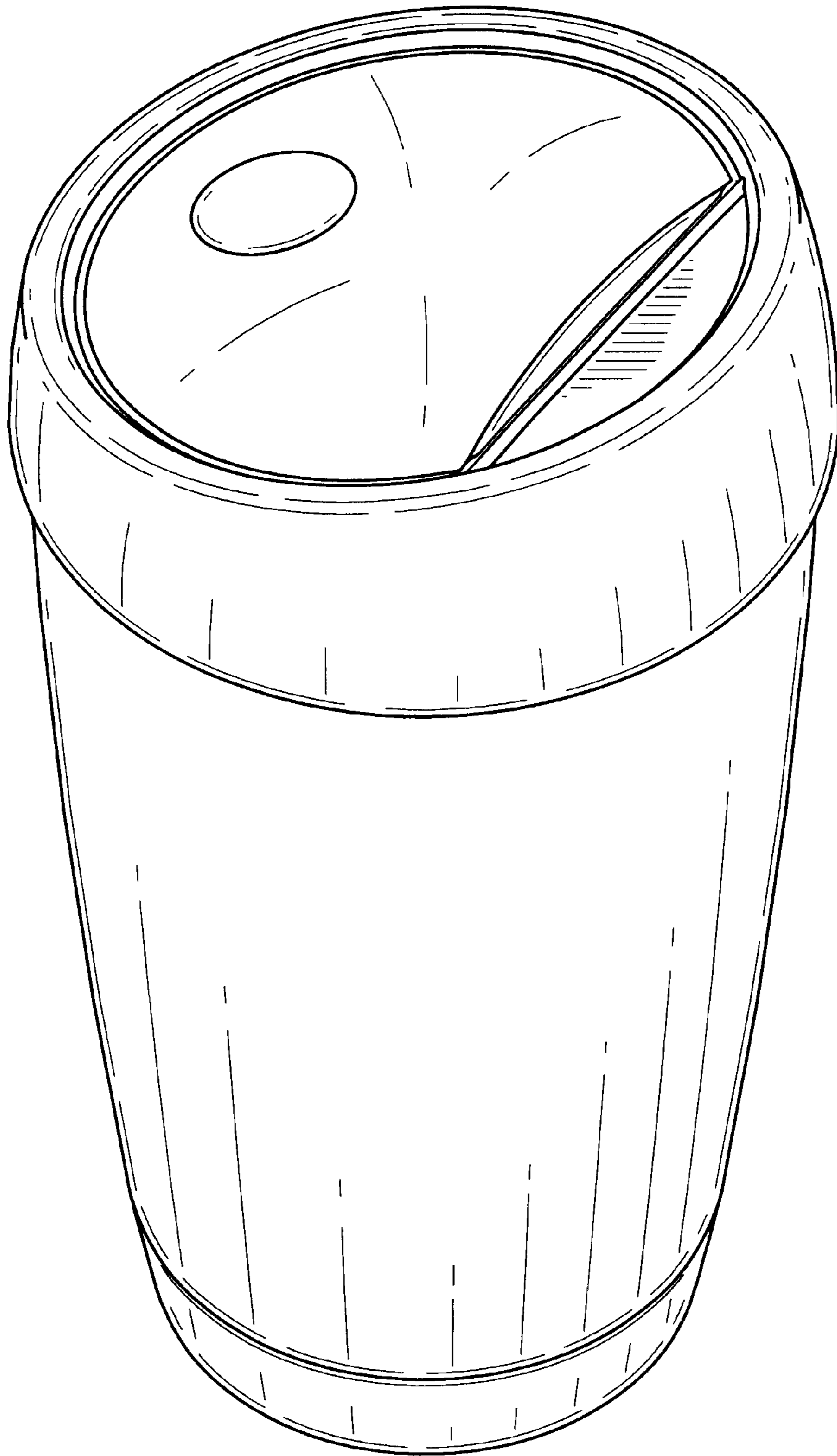

FIG-1

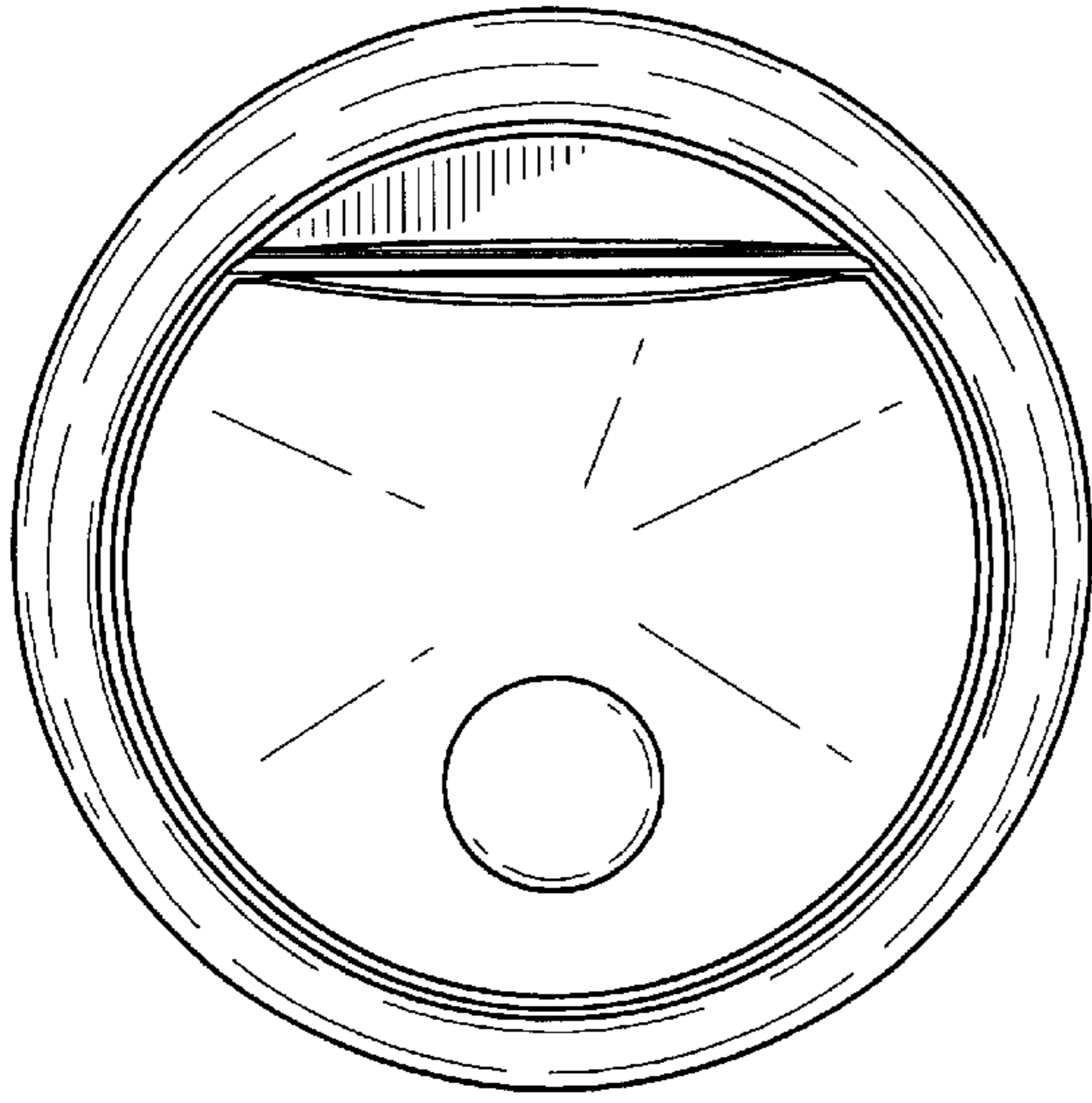

FIG-2

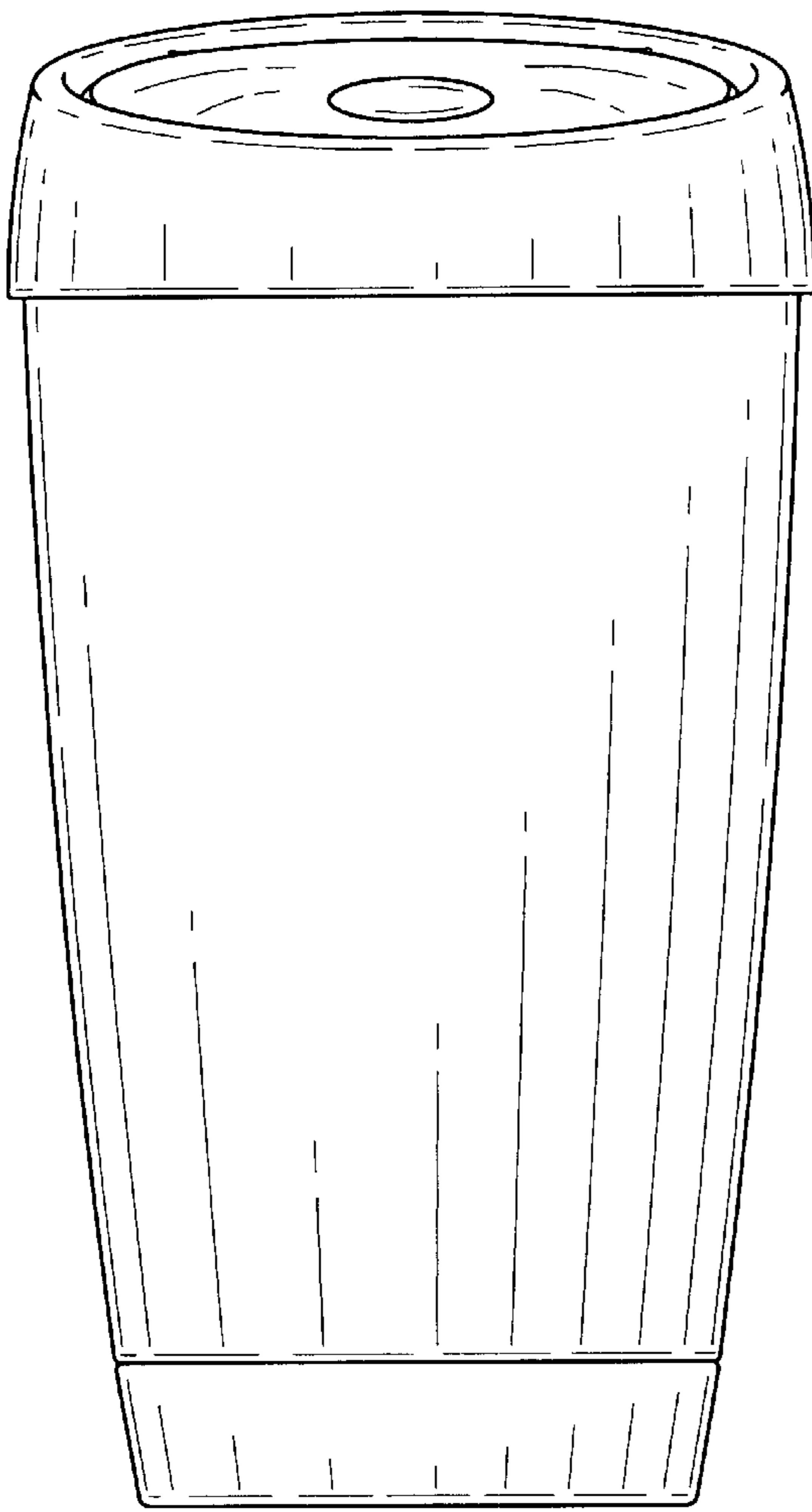

FIG-3

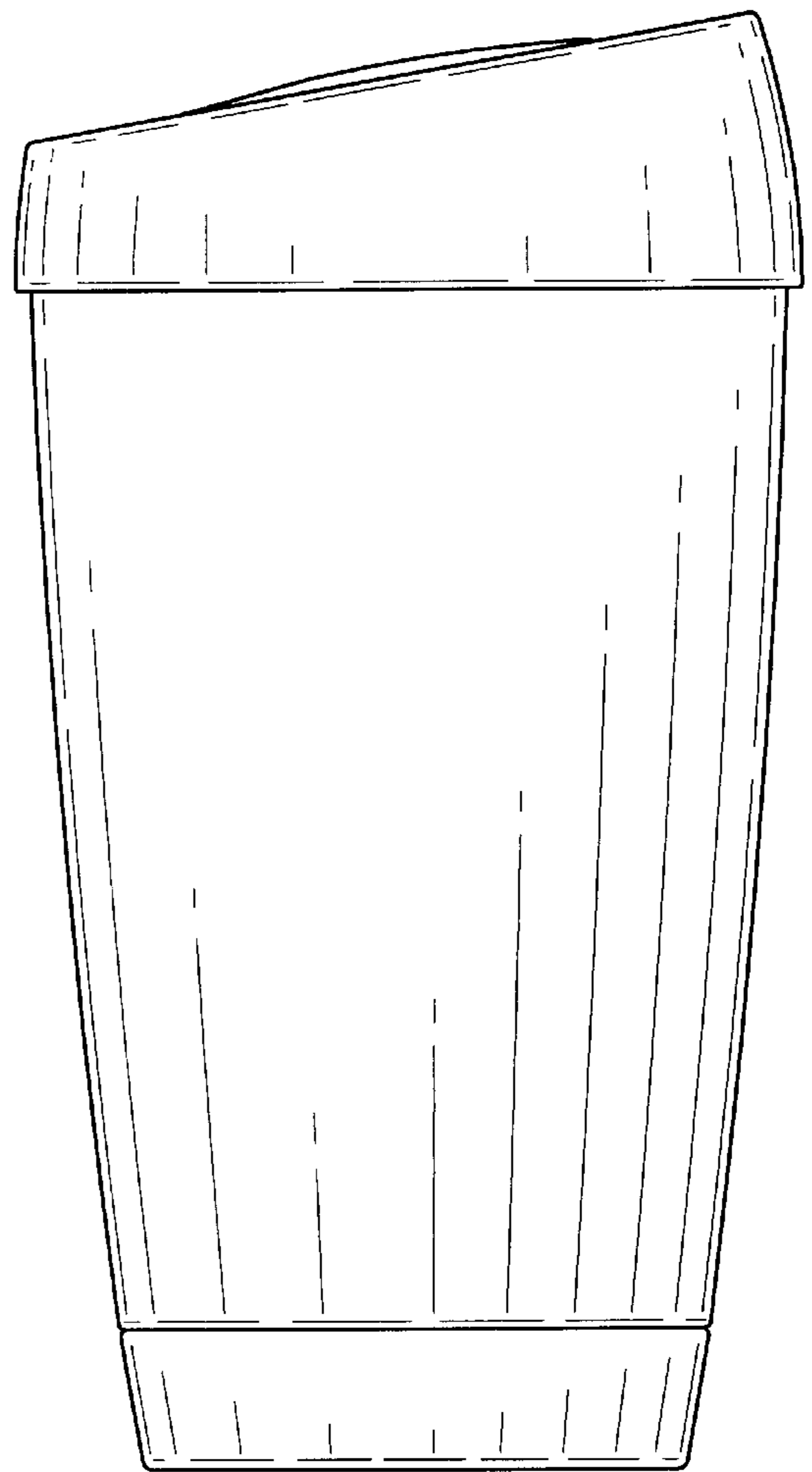

FIG-4

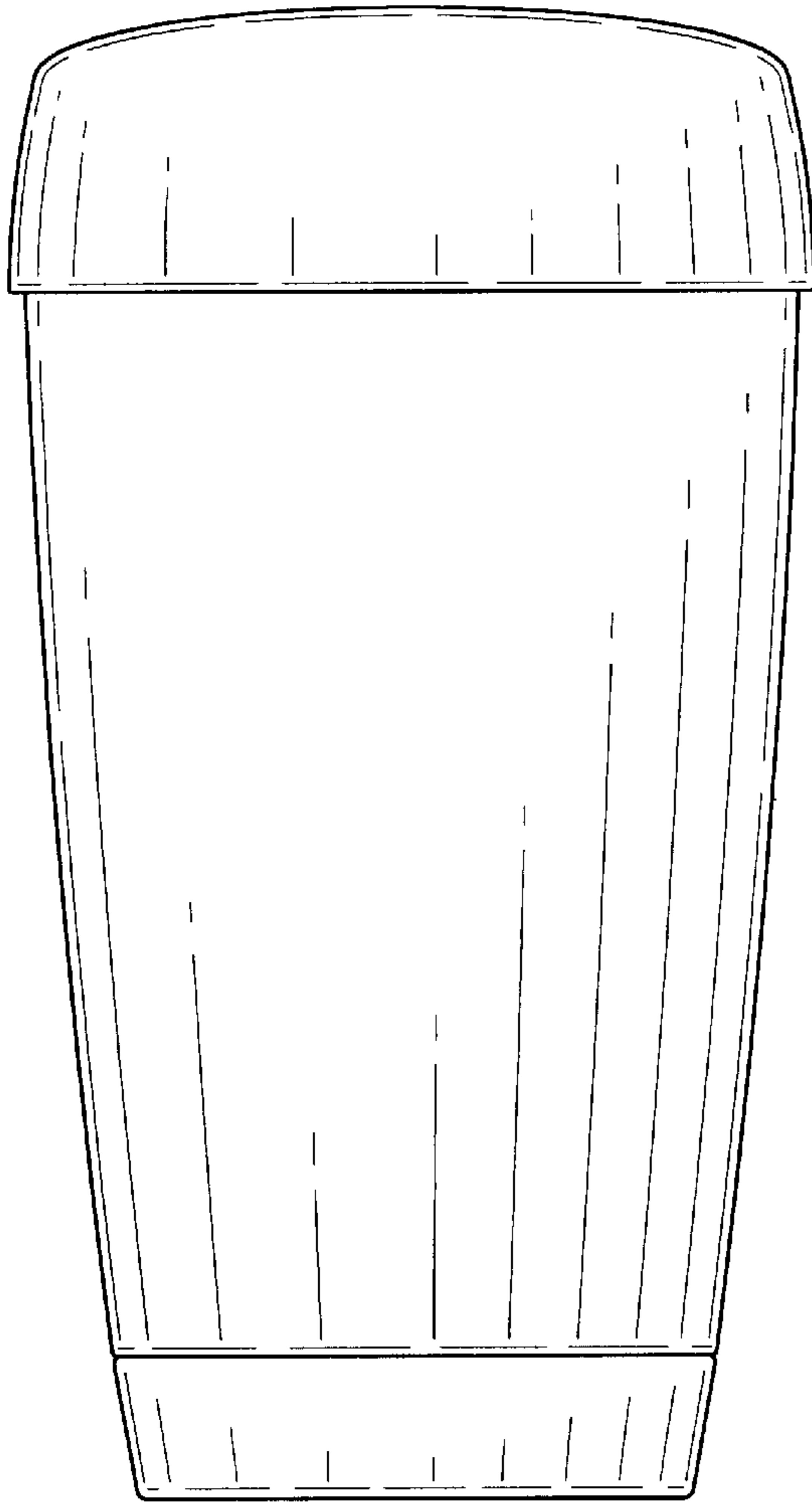

FIG-5

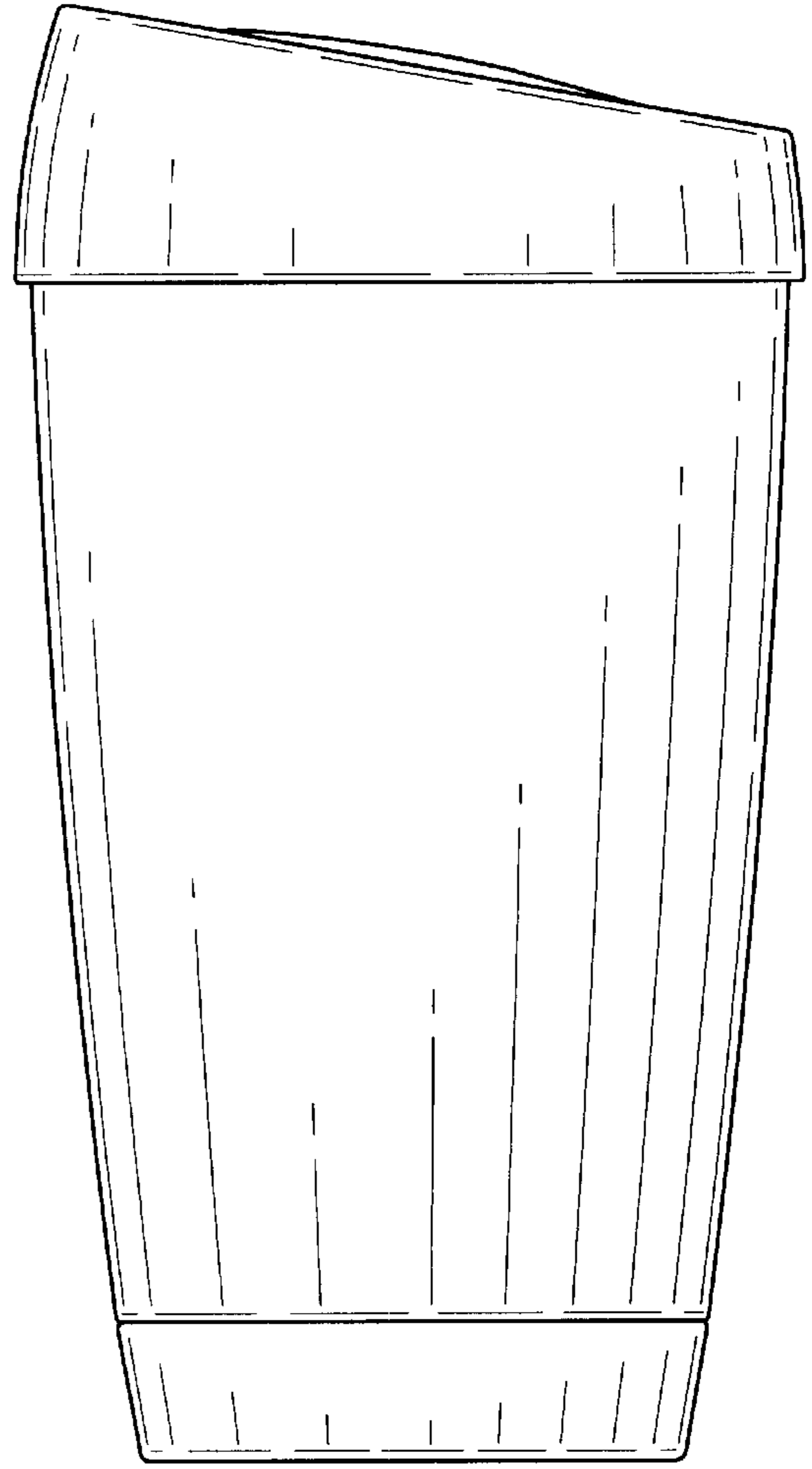

FIG-6

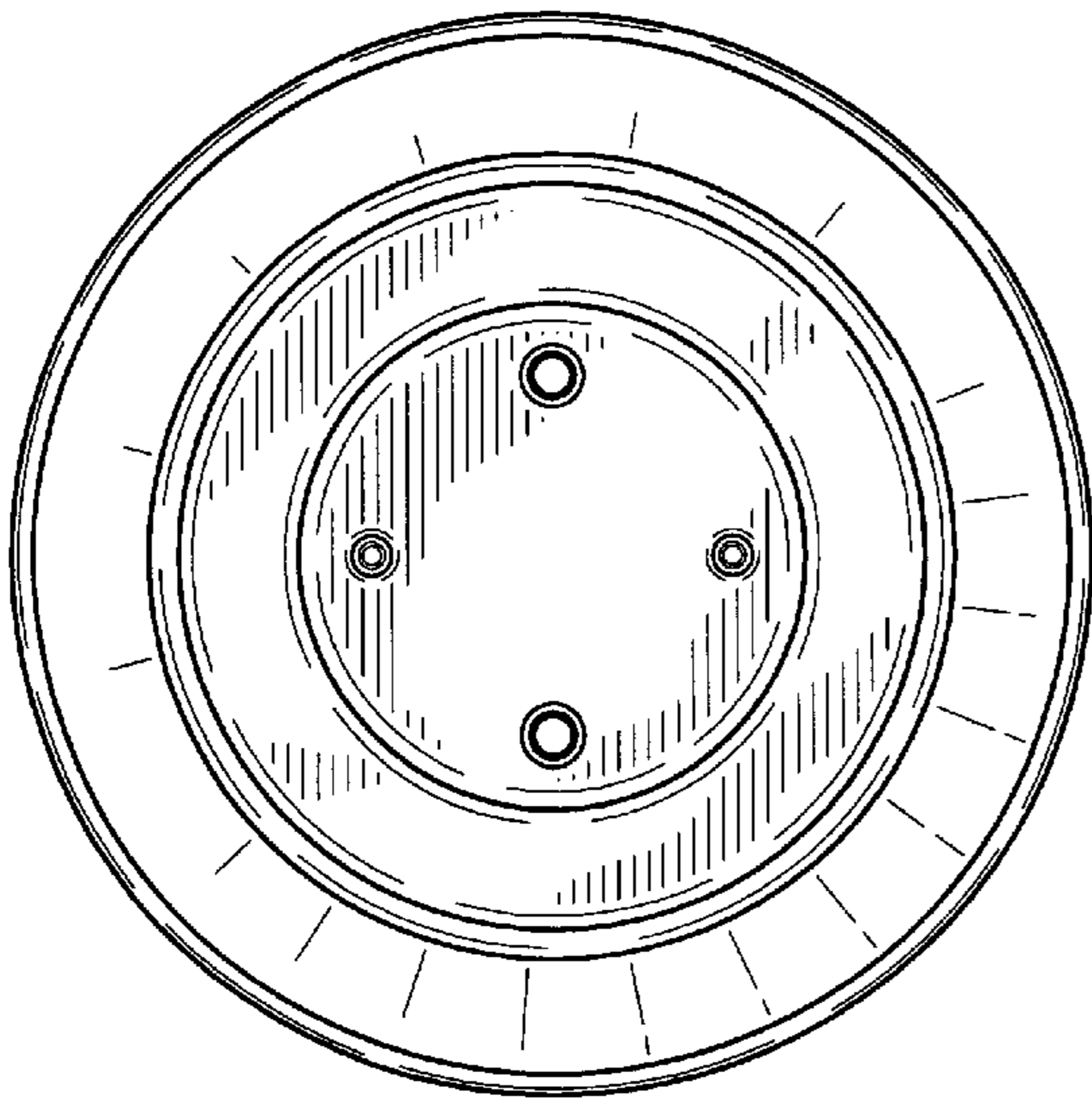

FIG-7