



US00D483160S

(12) **United States Design Patent**
Houghton

(10) **Patent No.:** **US D483,160 S**

(45) **Date of Patent:** **** Dec. 2, 2003**

(54) **VACUUM CLEANER**

(75) **Inventor:** **Stephen Andrew Houghton**, Newcastle Upon Tyne (GB)

(73) **Assignee:** **Black & Decker Inc.**, Newark, DE (US)

(**) **Term:** **14 Years**

(21) **Appl. No.:** **29/149,760**

(22) **Filed:** **Oct. 17, 2001**

(30) **Foreign Application Priority Data**

Apr. 18, 2001	(GB)	2101173
Apr. 18, 2001	(GB)	2101174
Apr. 18, 2001	(GB)	2101175
Apr. 18, 2001	(GB)	2101176
Apr. 18, 2001	(GB)	2101177
Apr. 18, 2001	(GB)	2101178

(51) **LOC (7) Cl.** **15-05**

(52) **U.S. Cl.** **D32/22**

(58) **Field of Search** D32/31-33, 22,
D32/25; 15/322, 327.1-327.7, 329, 362,
393, 398, 400-401, 415.1-422.1

(56) **References Cited**

U.S. PATENT DOCUMENTS

D220,970 S	6/1971	Rawson et al.	
D257,661 S	12/1980	Gantz	
D301,649 S	* 6/1989	Yamamoto et al. D32/22

(List continued on next page.)

OTHER PUBLICATIONS

Home Products Catalog (pp. 4-7 & 13 & 14) Year of publication 1999.

Picture of Dustbuster dated Nov. 1, 2000.

Primary Examiner—Ruth McInroy

(74) *Attorney, Agent, or Firm*—Ajay K. Gambhir

(57) **CLAIM**

The ornamental design for a vacuum cleaner, as shown and described.

DESCRIPTION

FIG. 1 is a perspective view of a vacuum cleaner taken from the front and one side;
 FIG. 2 is a front elevational view thereof;
 FIG. 3 is a rear elevational view thereof;
 FIG. 4 is a side view taken from the side opposite that illustrated in FIG. 1;
 FIG. 5 is a side elevational view thereof taken from the side illustrated in FIG. 1;
 FIG. 6 is a top view thereof;
 FIG. 7 is a bottom view thereof;
 FIG. 8 is a perspective view of a lower portion of the vacuum illustrated in FIG. 1 taken from the front and one side;
 FIG. 9 is a front elevational view thereof;
 FIG. 10 is a rear elevational view thereof;
 FIG. 11 is a side elevational view taken from the side opposite that illustrated in FIG. 8;
 FIG. 12 is a side elevational view taken from the side illustrated in FIG. 8;
 FIG. 13 is a top view thereof;
 FIG. 14 is a bottom view thereof;
 FIG. 15 is a perspective view of a handle portion of the vacuum illustrated in FIG. 1 taken from the front and one side;
 FIG. 16 is a front elevational view thereof;
 FIG. 17 is a rear elevational view thereof;
 FIG. 18 is a side elevational view thereof taken from the side opposite that shown in FIG. 15;
 FIG. 19 is a side elevational view thereof taken from the side illustrated in FIG. 15;
 FIG. 20 is a top view thereof; and,
 FIG. 21 is a bottom view thereof.

The details shown in broken lines are for illustrative purposes only and form no part of the claimed design. FIGS. 8-14 showing the lower portion of the vacuum cleaner and FIGS. 15-21 showing the handle, are shown separate for clarity of illustration, the claim being directed to the entire vacuum cleaner shown in FIGS. 1-7.

1 Claim, 15 Drawing Sheets

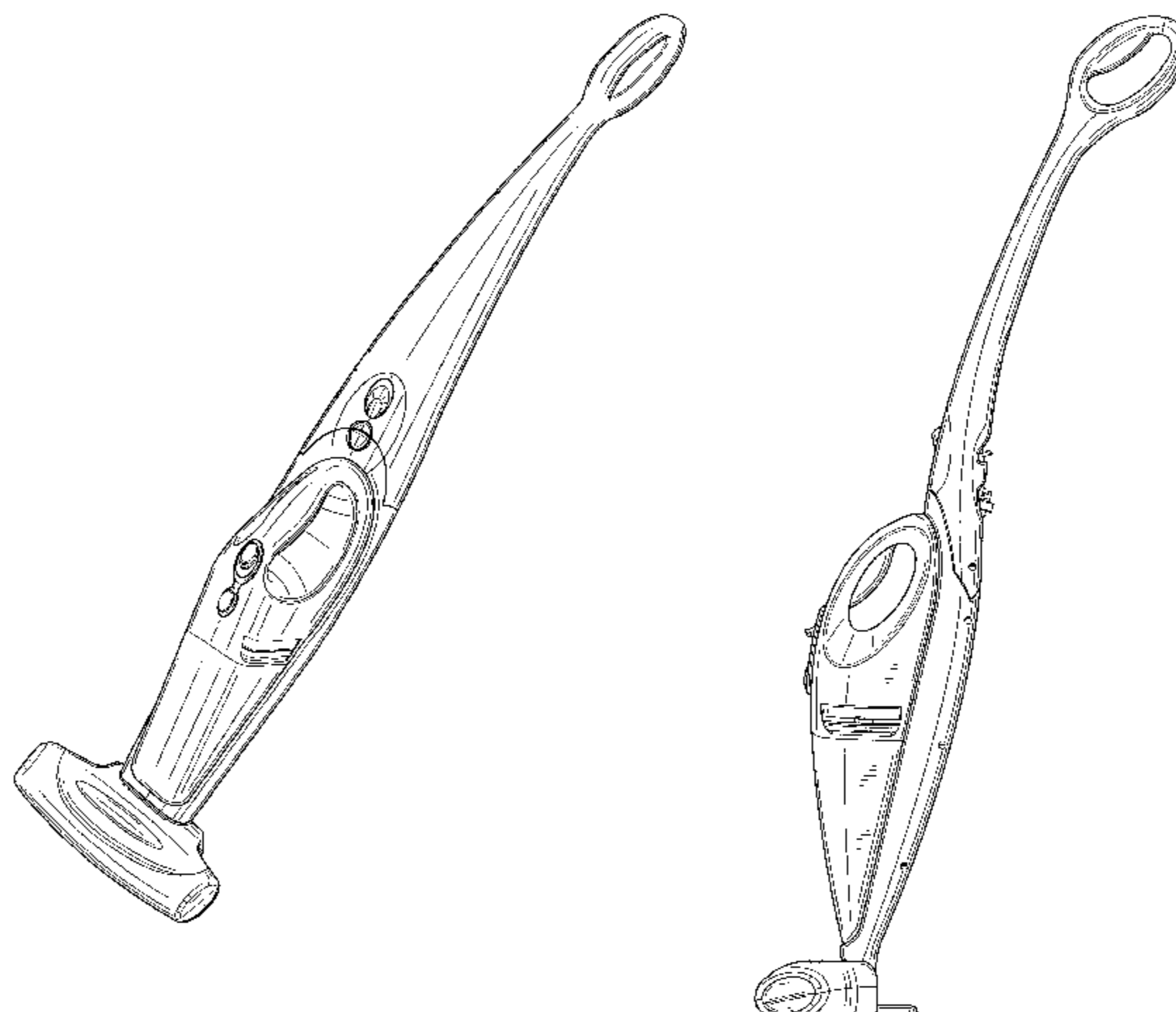

US D483,160 S

Page 2

U.S. PATENT DOCUMENTS

D304,104 S	10/1989	Busalt et al.	
D306,225 S	2/1990	Correa	
D307,656 S	* 5/1990	Yuen	D32/22
D307,657 S	* 5/1990	Li	D32/22
D314,846 S	2/1991	deBlois	
D315,622 S	3/1991	deBlois et al.	
D316,921 S	5/1991	Gerke, Jr. et al.	
D377,697 S	* 1/1997	Stephens et al.	D32/31
D380,022 S	6/1997	Kusumi et al.	
D398,096 S	* 9/1998	Gildersleeve	D32/22
D399,618 S	10/1998	Jacobs	
D418,266 S	* 12/1999	Medema et al.	D32/22
D421,671 S	3/2000	Thomas et al.	
D437,666 S	2/2001	Park	
D441,152 S	4/2001	Stratford	
D456,964 S	* 5/2002	Alford et al.	D32/31

* cited by examiner

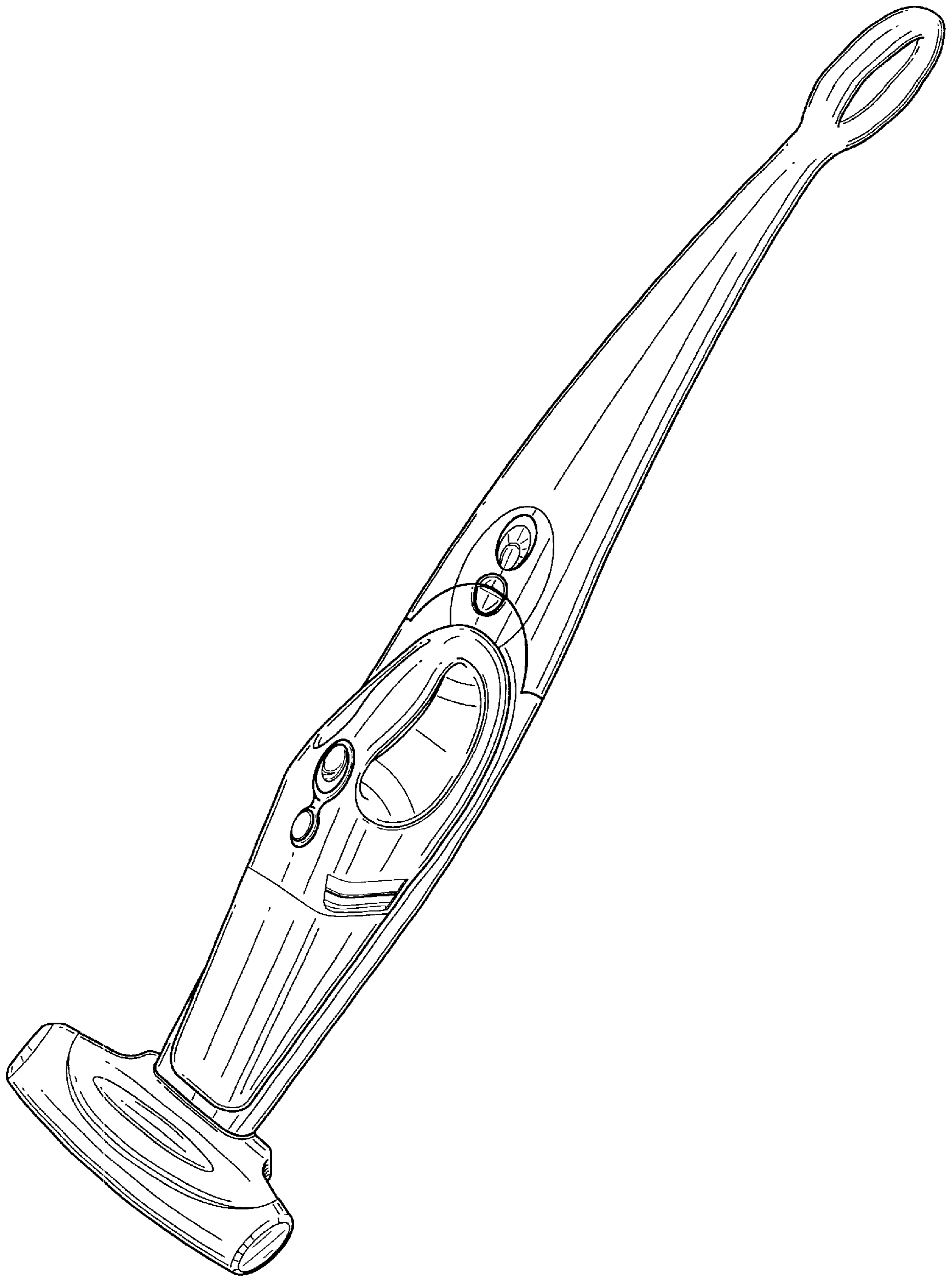

FIG. 1

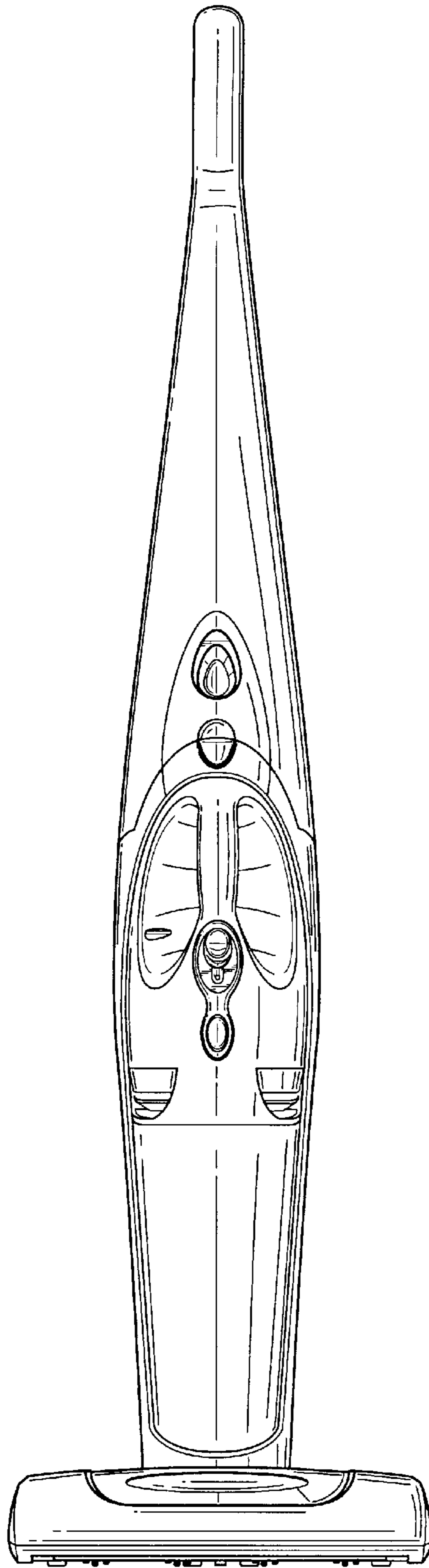

FIG. 2

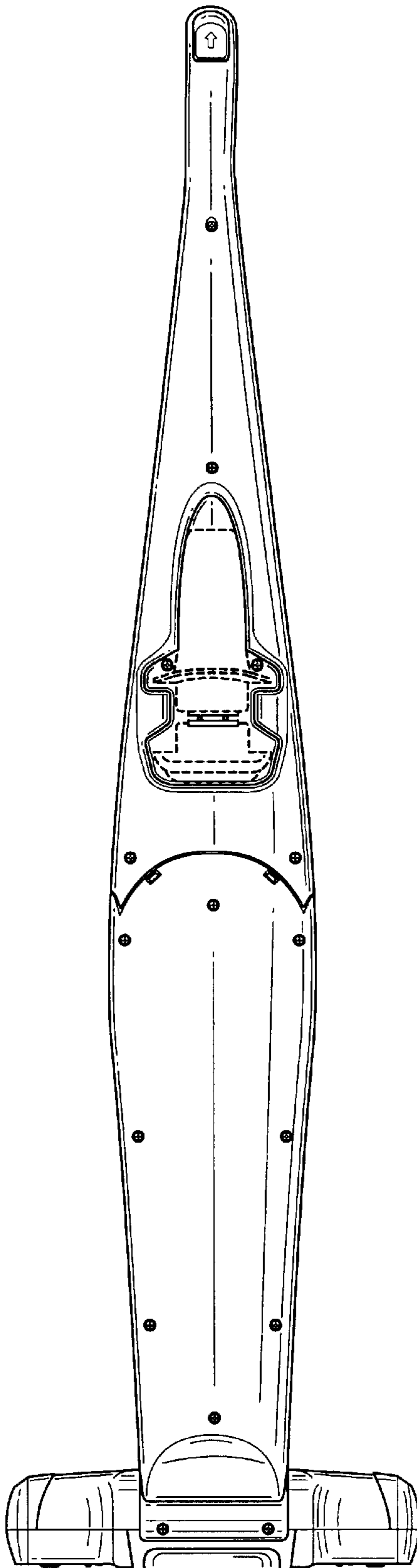

FIG. 3

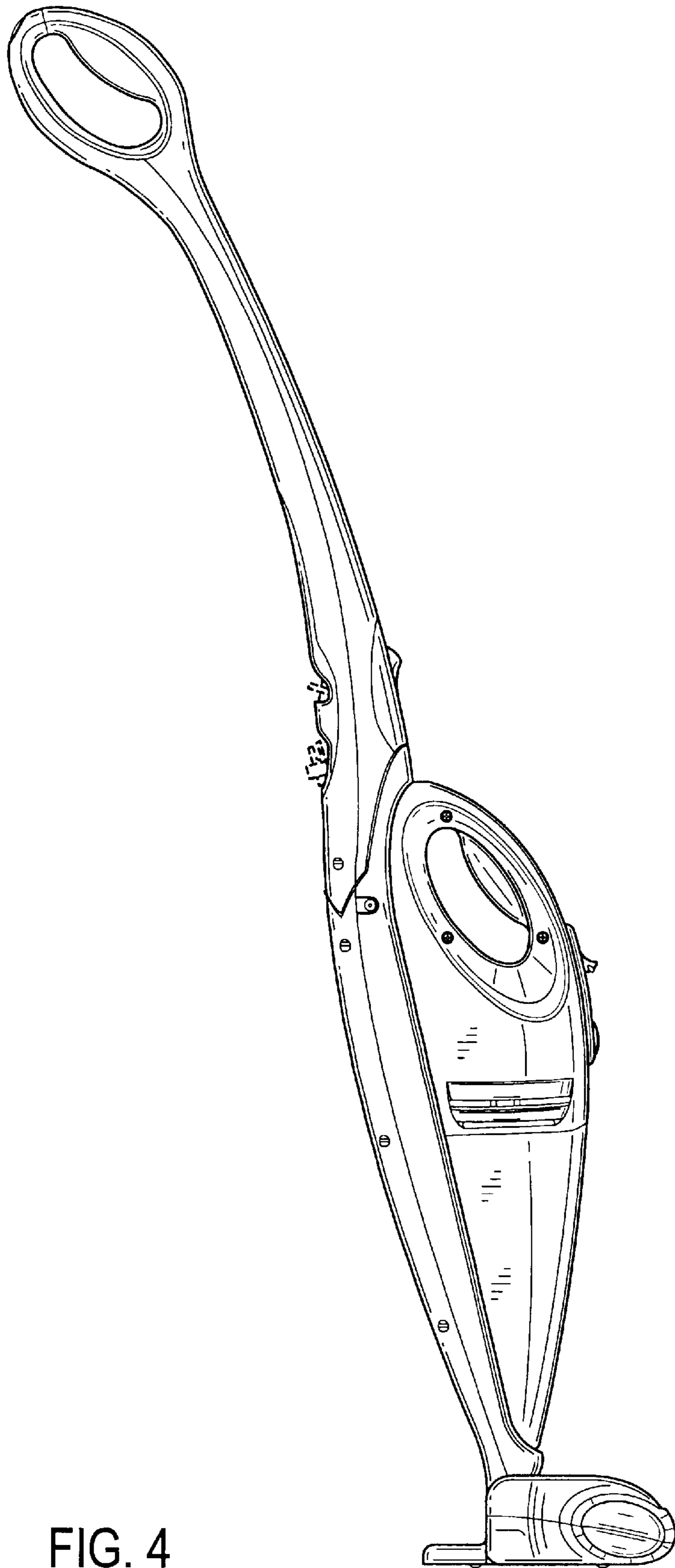

FIG. 4

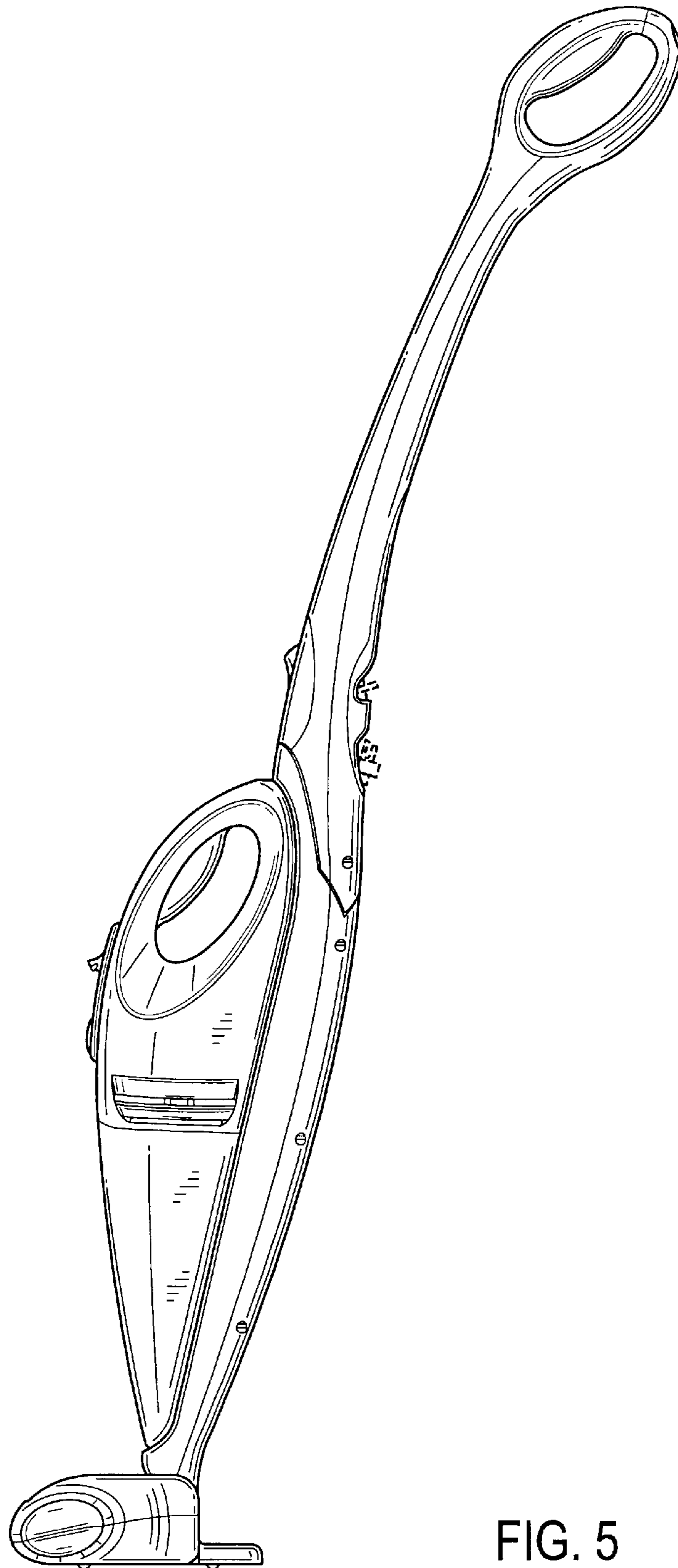

FIG. 5

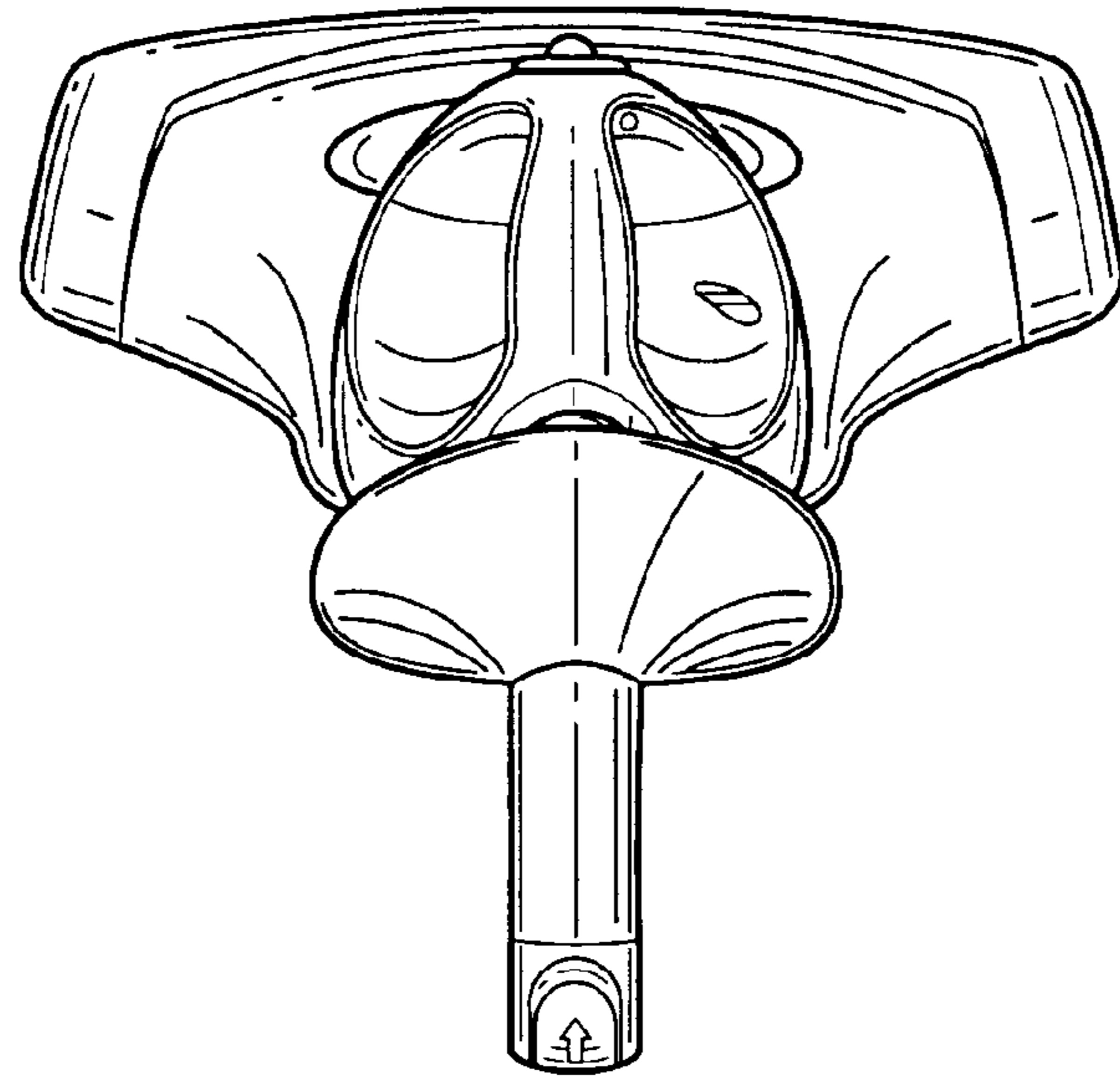

FIG. 6

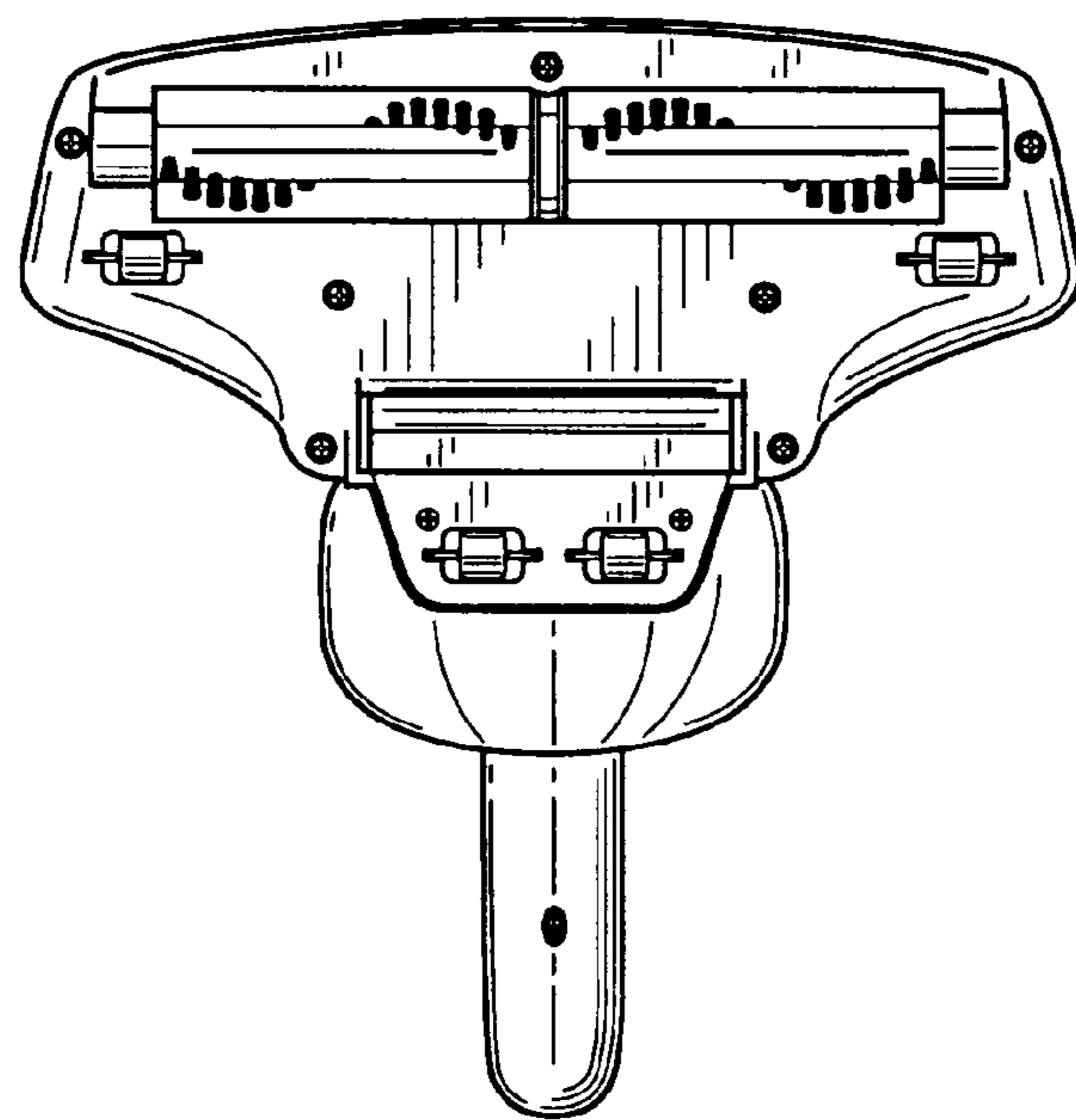

FIG. 7

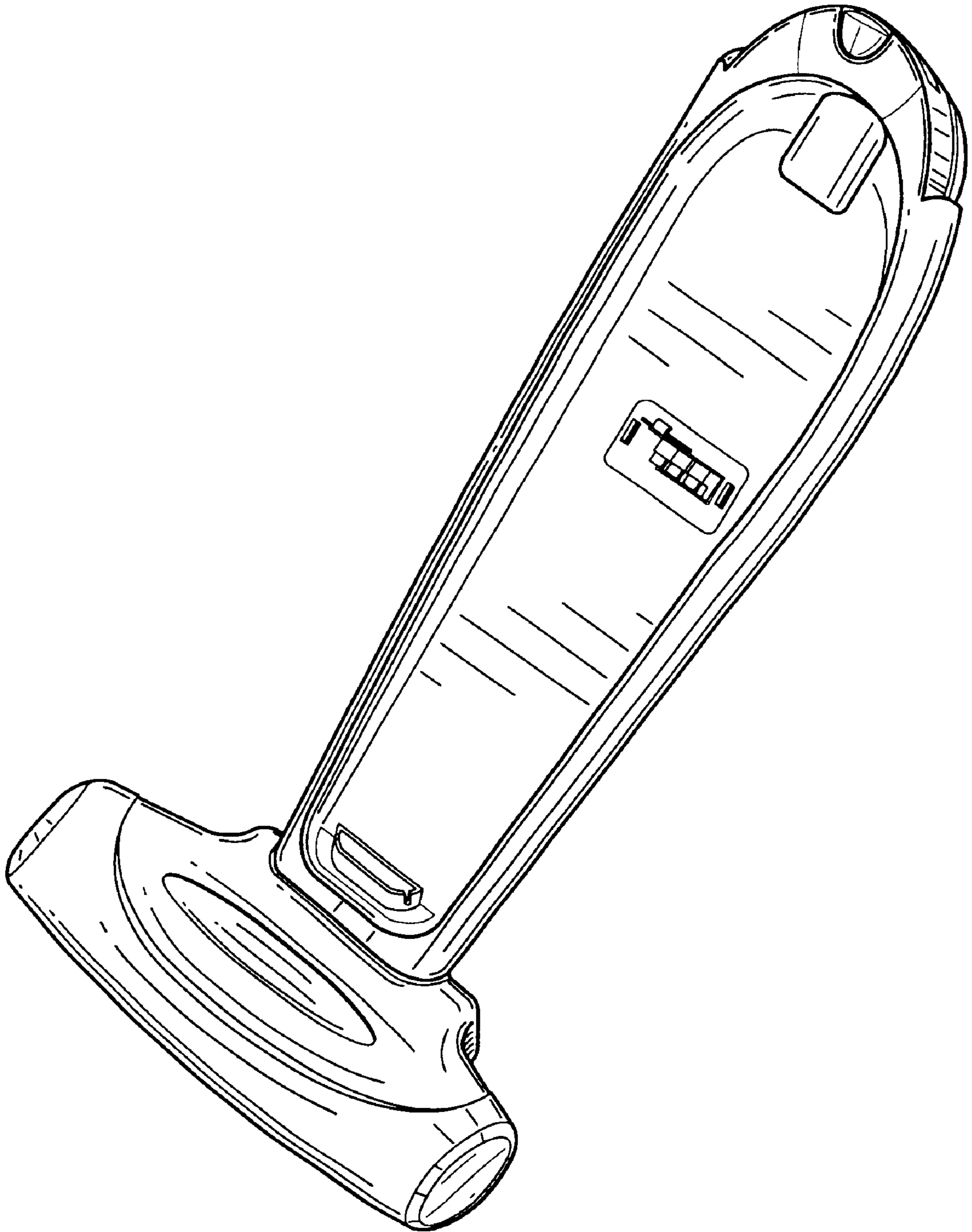

FIG. 8

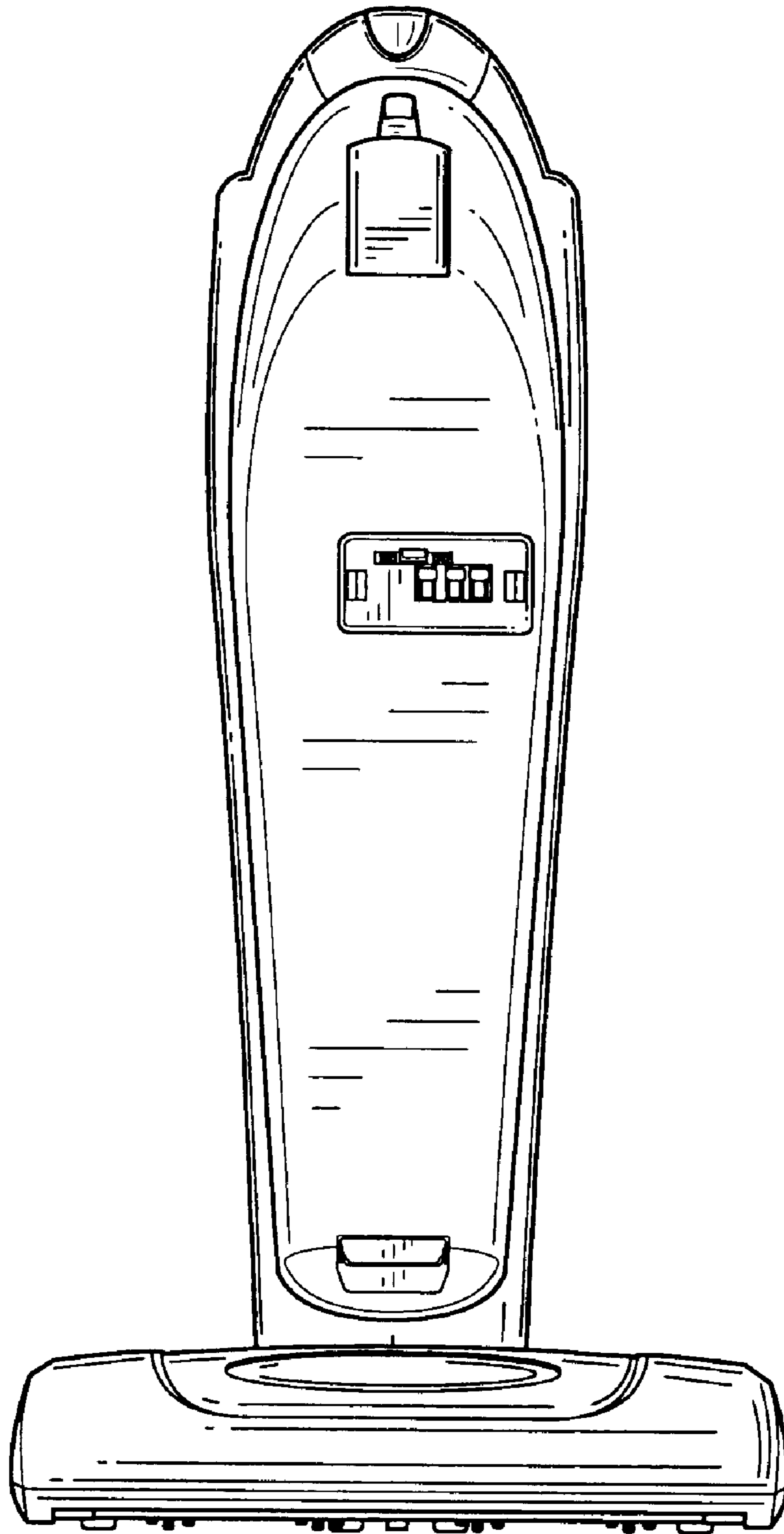

FIG. 9

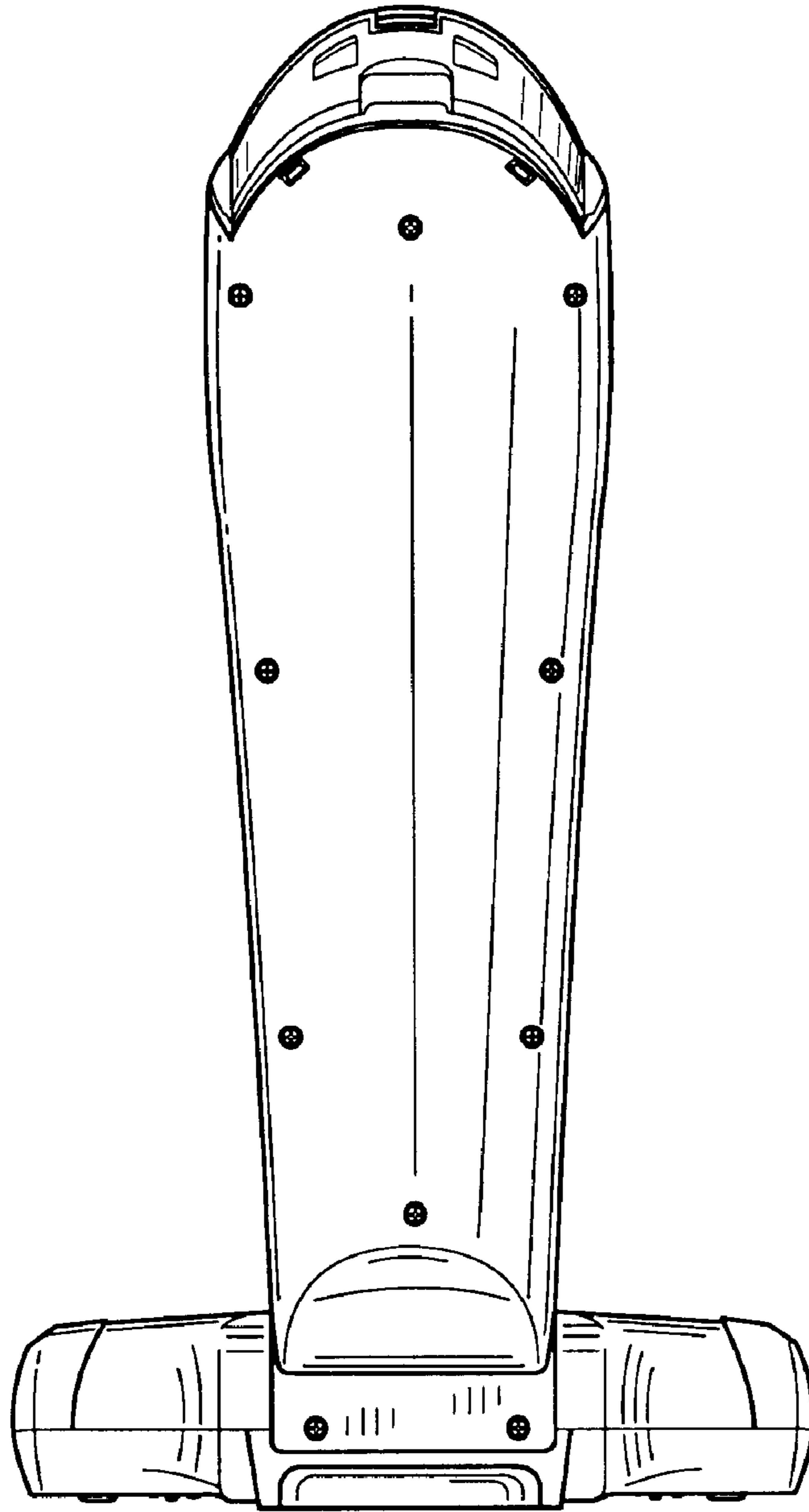

FIG. 10

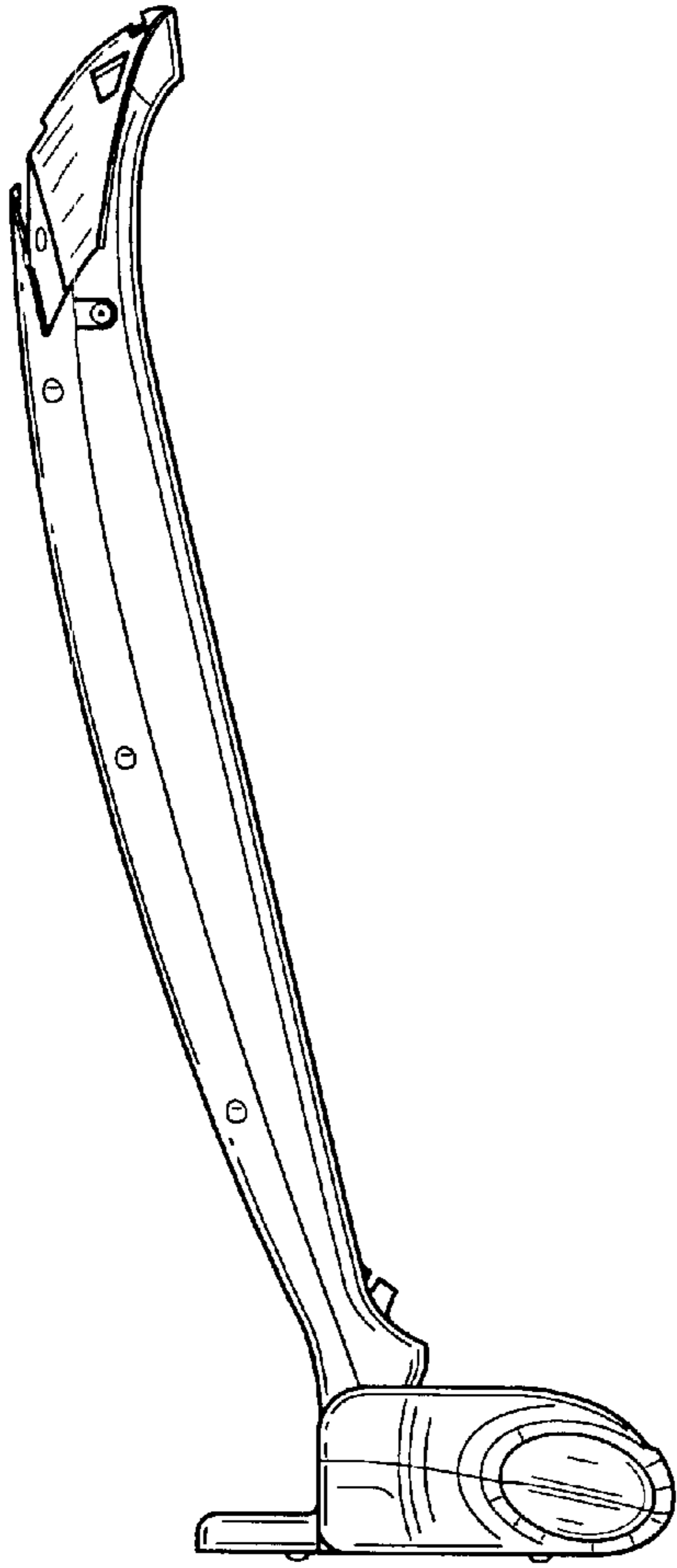

FIG. 11

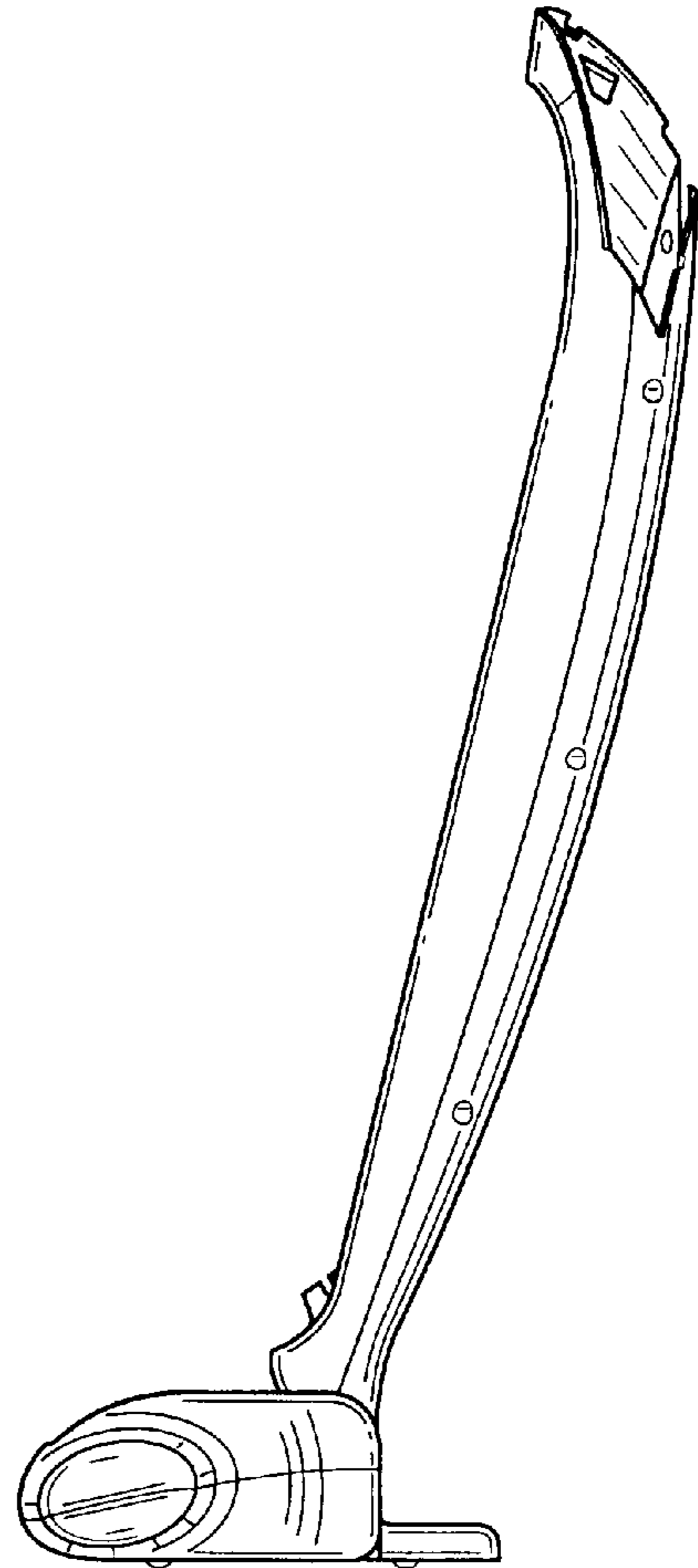

FIG. 12

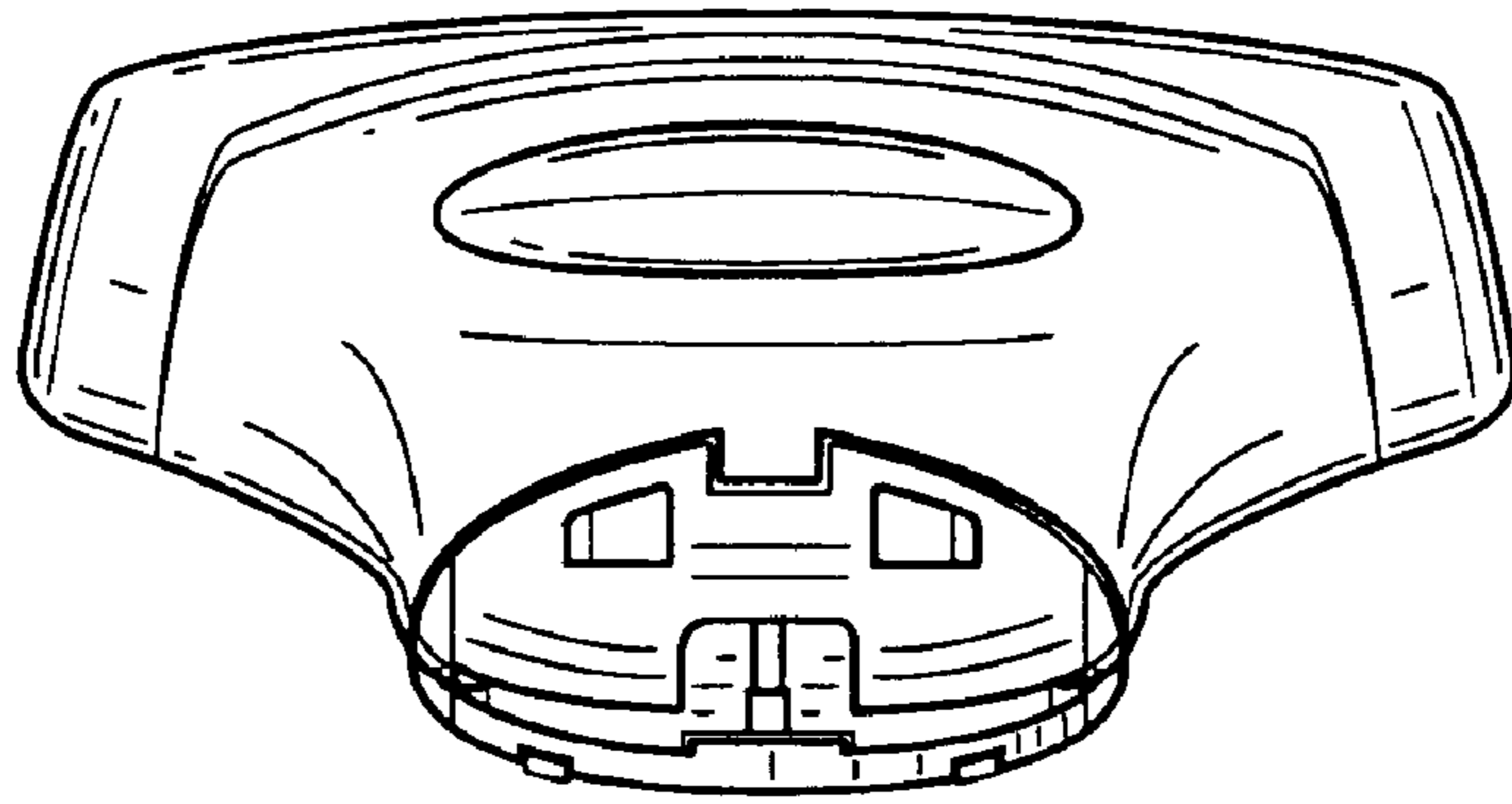

FIG. 13

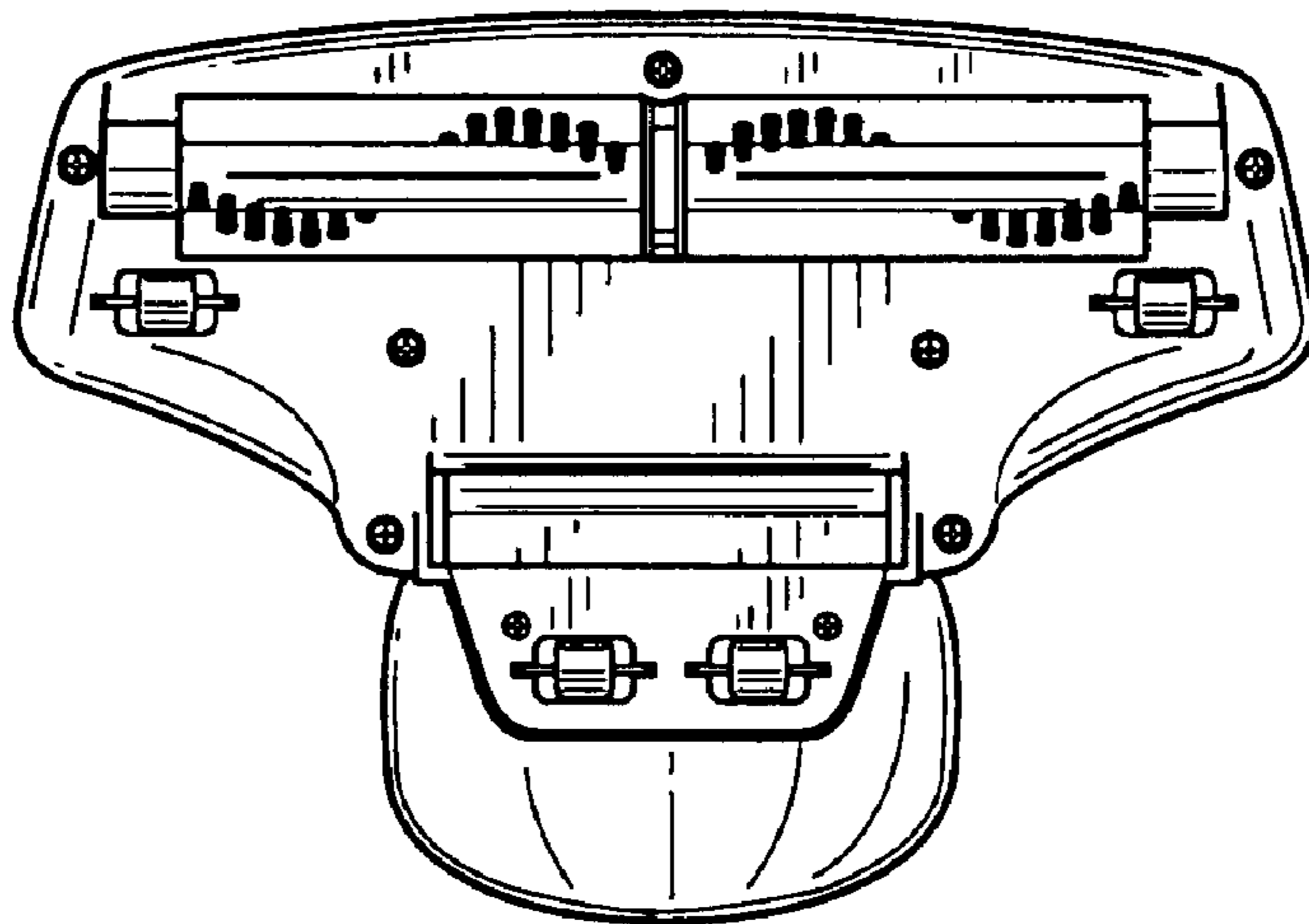

FIG. 14

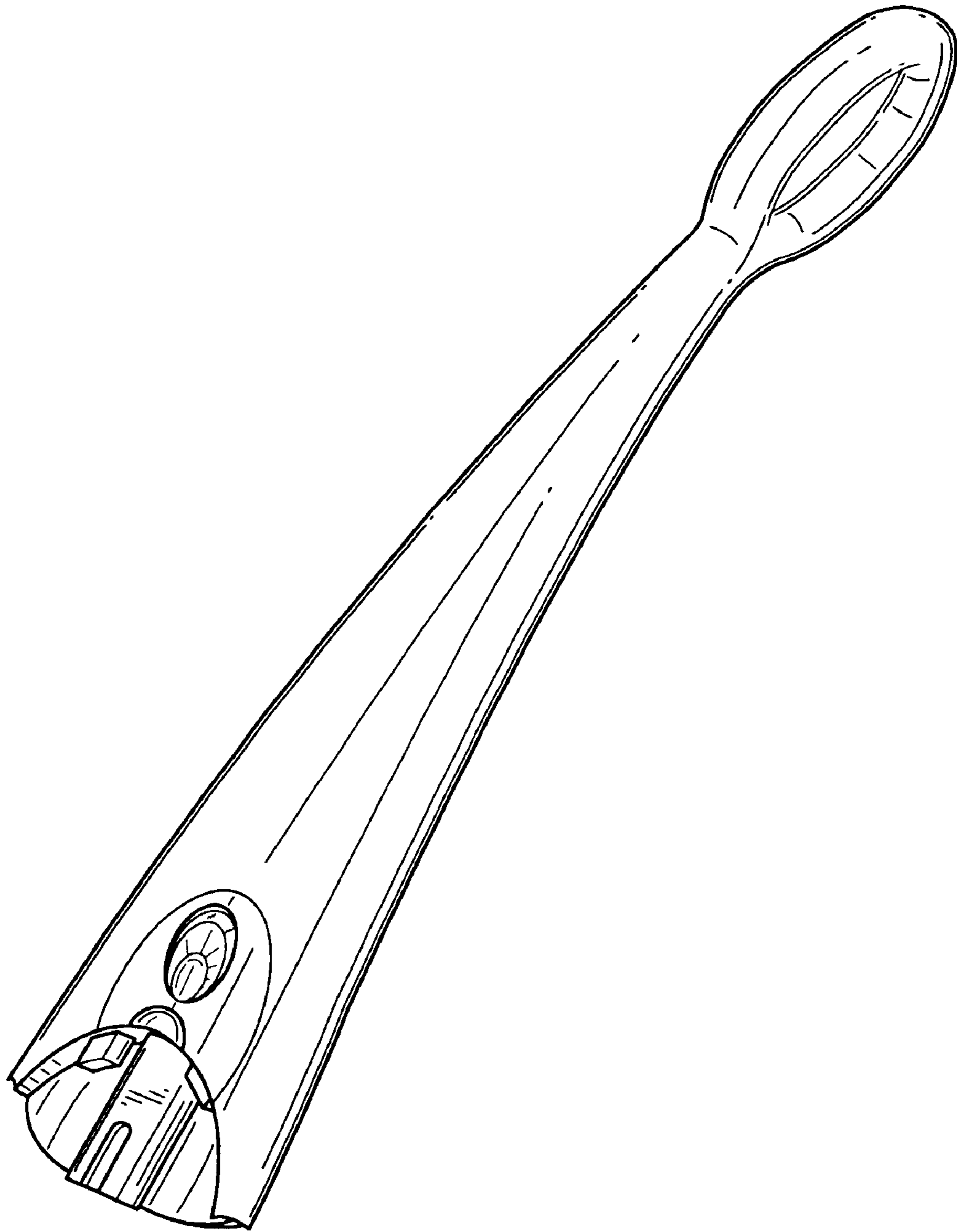

FIG. 15

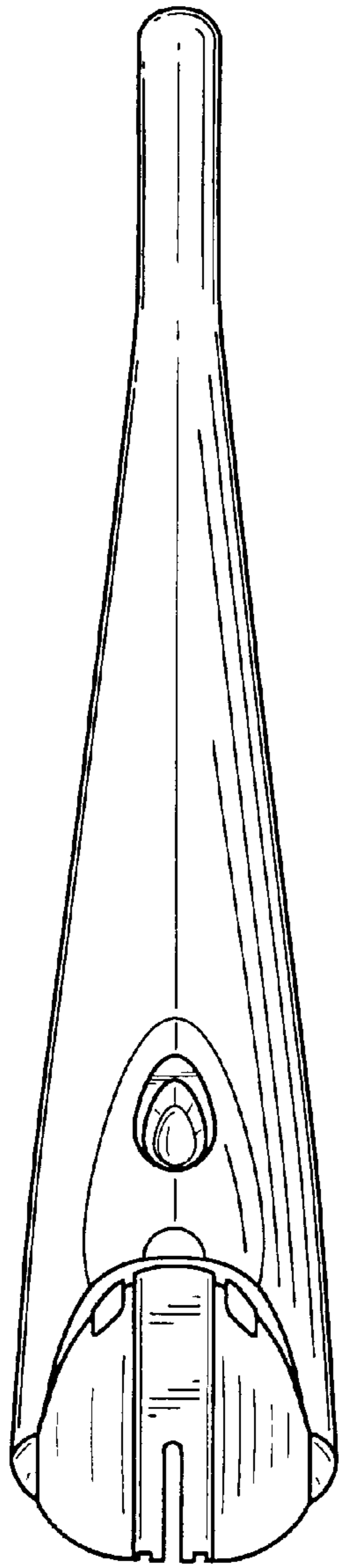

FIG. 16

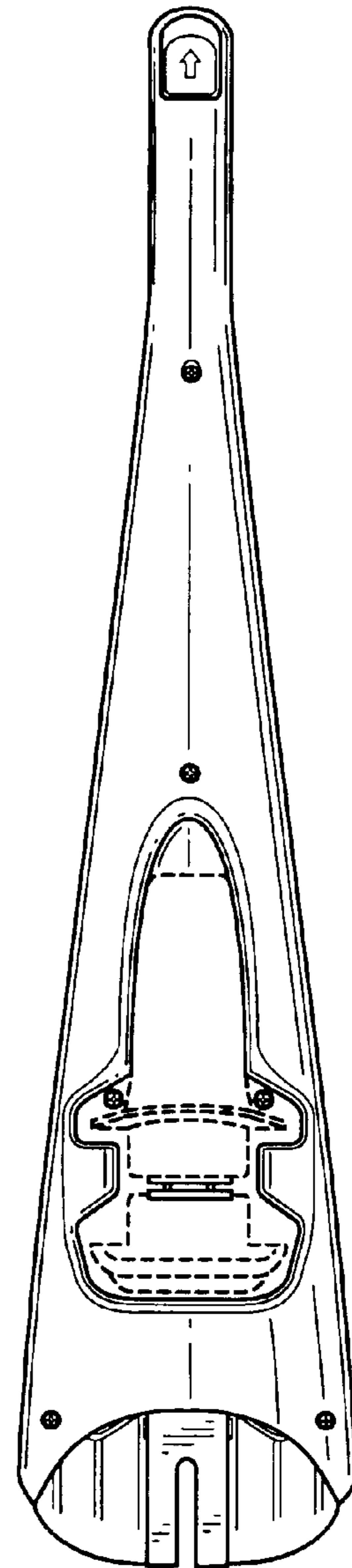

FIG. 17

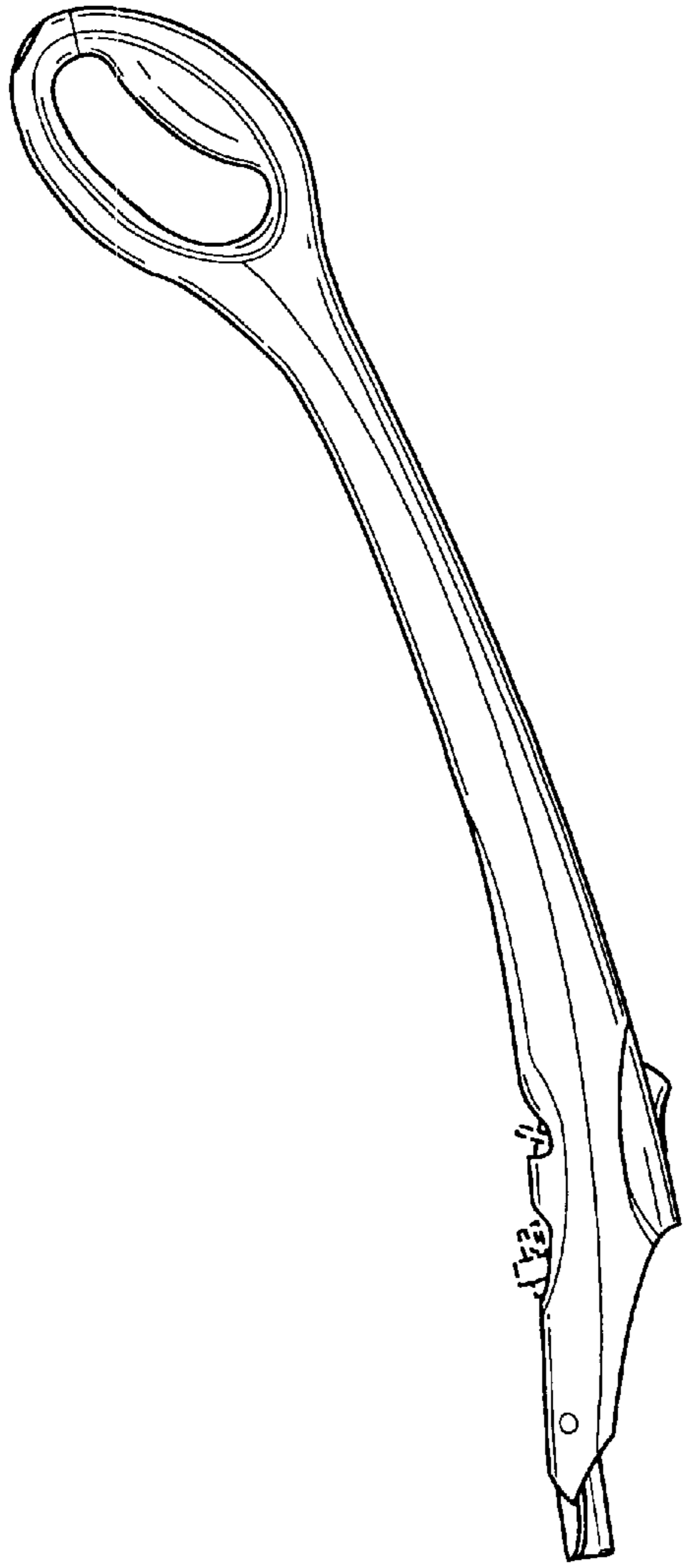

FIG. 18

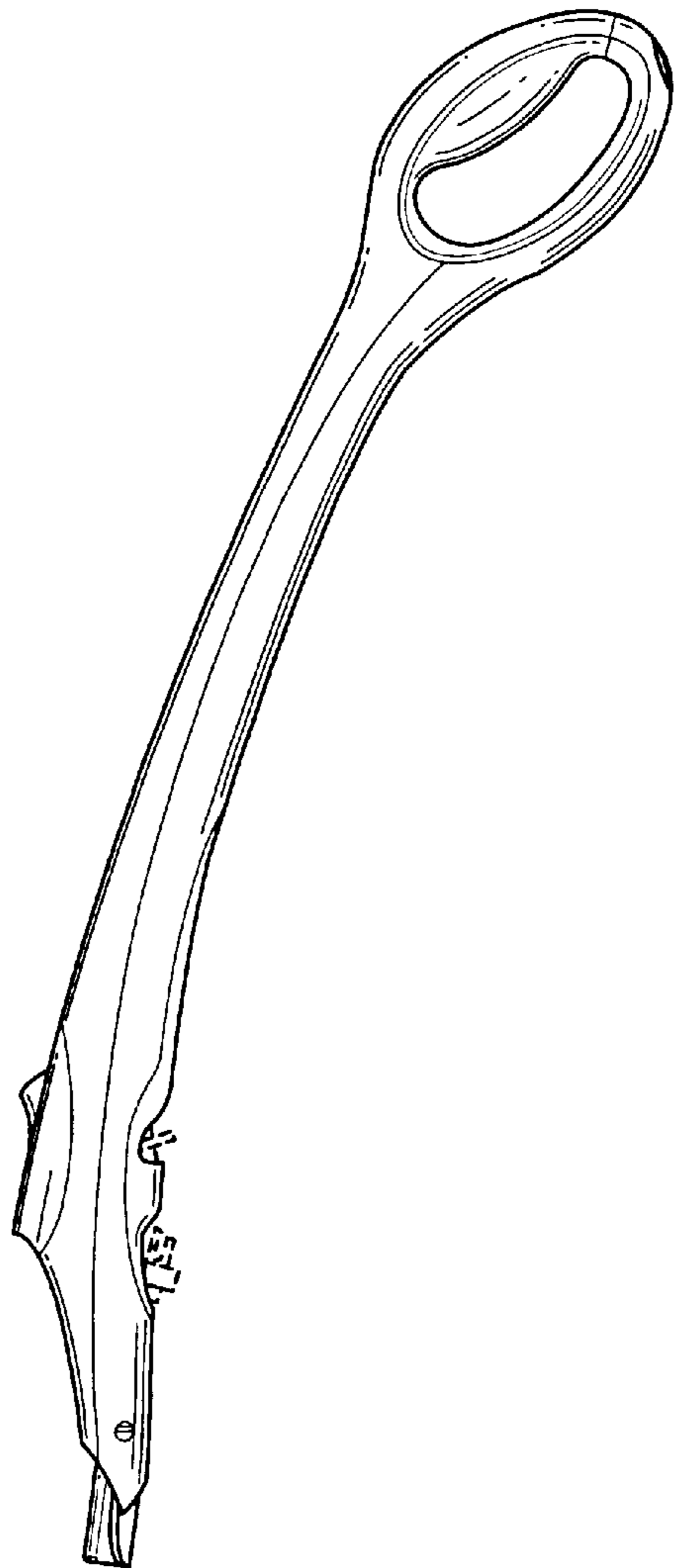

FIG. 19

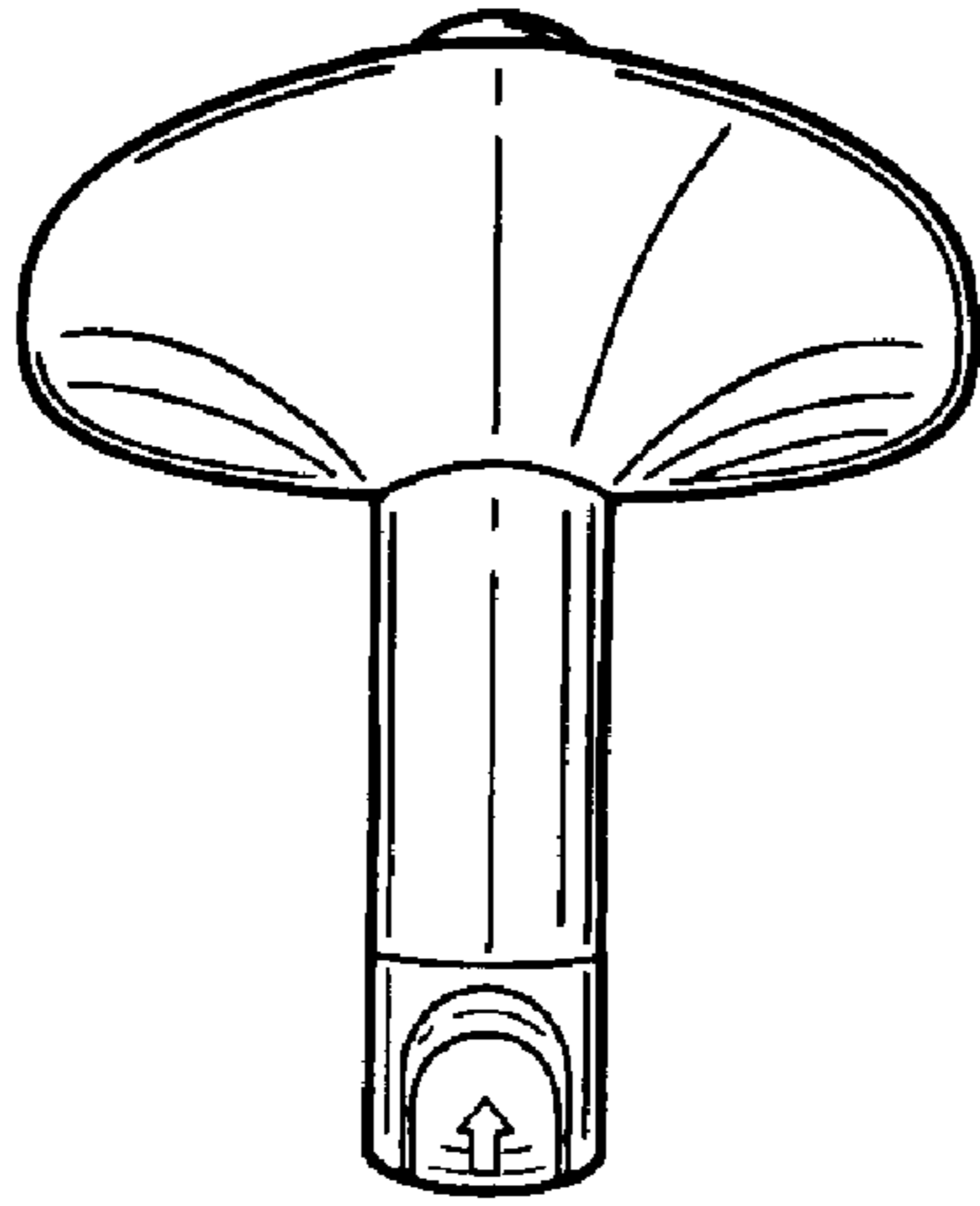

FIG. 20

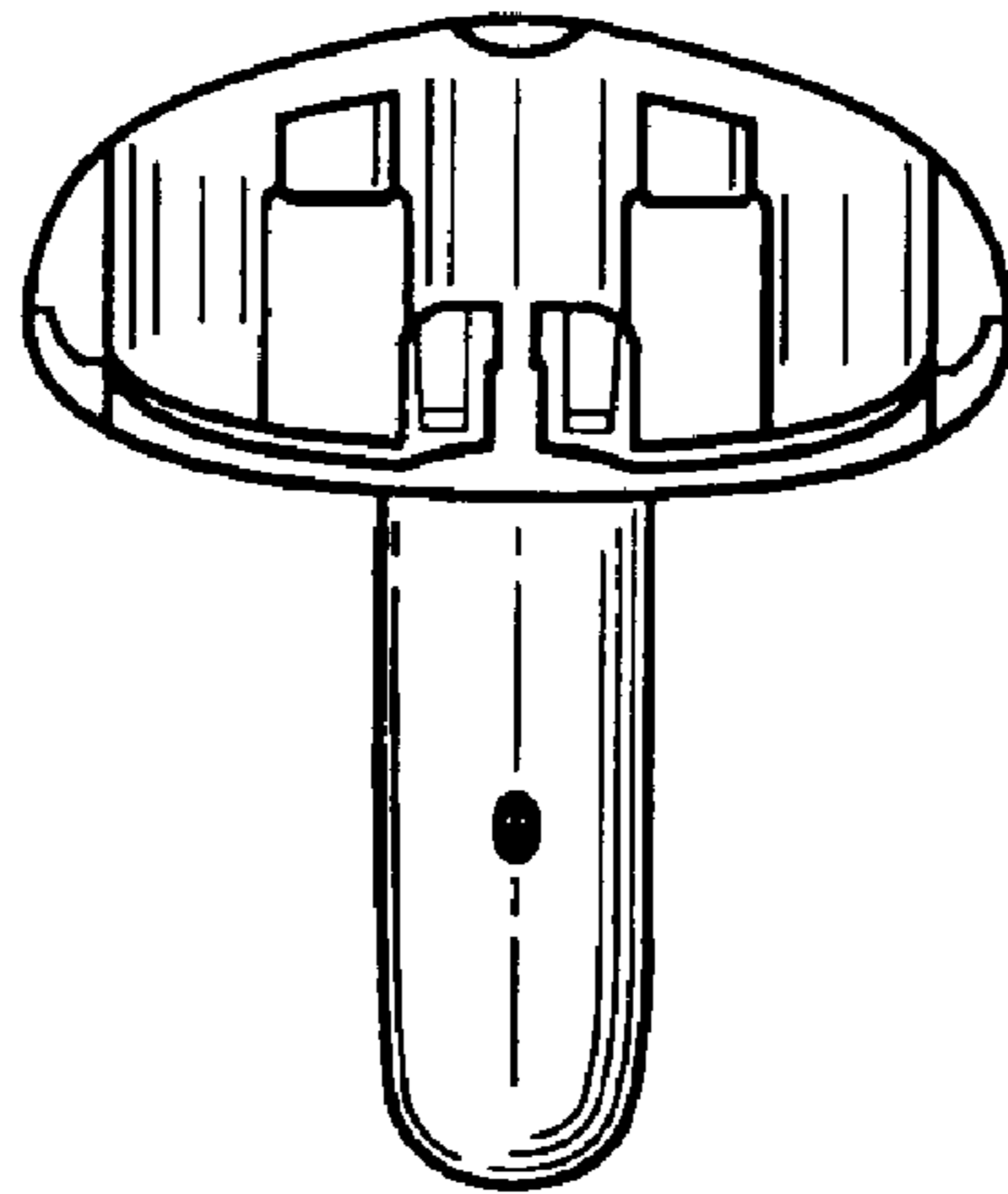

FIG. 21