



US00D483115S

(12) **United States Design Patent**  
**Pasternak**

(10) **Patent No.:** **US D483,115 S**

(45) **Date of Patent:** **\*\* Dec. 2, 2003**

(54) **INHALATION DEVICE**

(75) Inventor: **Gary Pasternak**, Bantford (CA)

(73) Assignee: **SmithKline Beecham Corporation**,  
Philadelphia, PA (US)

(\*\*) Term: **14 Years**

(21) Appl. No.: **29/171,441**

(22) Filed: **Nov. 22, 2002**

(51) **LOC (7) Cl.** ..... **29-02**

(52) **U.S. Cl.** ..... **D24/110**

(58) **Field of Search** ..... D24/110, 115;  
128/200.23, 200.22, 203.23, 200.14, 200.12,  
203.12, 203.15; 222/153.11, 153.13, 153.14

(56) **References Cited**

**U.S. PATENT DOCUMENTS**

4,860,738 A \* 8/1989 Hegemann et al. .... 128/200.22

\* cited by examiner

*Primary Examiner*—Ian Simmons

(74) *Attorney, Agent, or Firm*—James P. Riek

(57) **CLAIM**

The ornamental design for an inhalation device, as shown and described.

**DESCRIPTION**

FIG. 1 is a perspective view of the inhalation device of our new design (with a nasal adapter cover cap);

FIG. 2 is a side view of of the inhalation device depicted in FIG. 1.

FIG. 3 is a rear view of the inhalation device depicted in FIG. 1.

FIG. 4 is a side view of the opposite side of the inhalation device depicted in FIG. 2;

FIG. 5 is a front view of the inhalation device depicted in FIG. 1;

FIG. 6 is a top view of the inhalation device depicted in FIG. 1;

FIG. 7 is a bottom view of the inhalation device depicted in FIG. 1;

FIG. 8 is a perspective view of the inhalation device of our new design (with a cover cap shown in relief);

FIG. 9 is a side view of the inhalation device depicted in FIG. 8 (without a cover cap).

FIG. 10 is a rear view of the inhalation device as depicted in FIG. 8.

FIG. 11 is a side view of the opposite side of FIG. 9.

FIG. 12 is a front view of the inhalation device as depicted in FIG. 8.

FIG. 13 is a top view of the inhalation device as depicted in FIG. 8; and,

FIG. 14 is a bottom view of the inhalation device as depicted in FIG. 8.

**1 Claim, 5 Drawing Sheets**

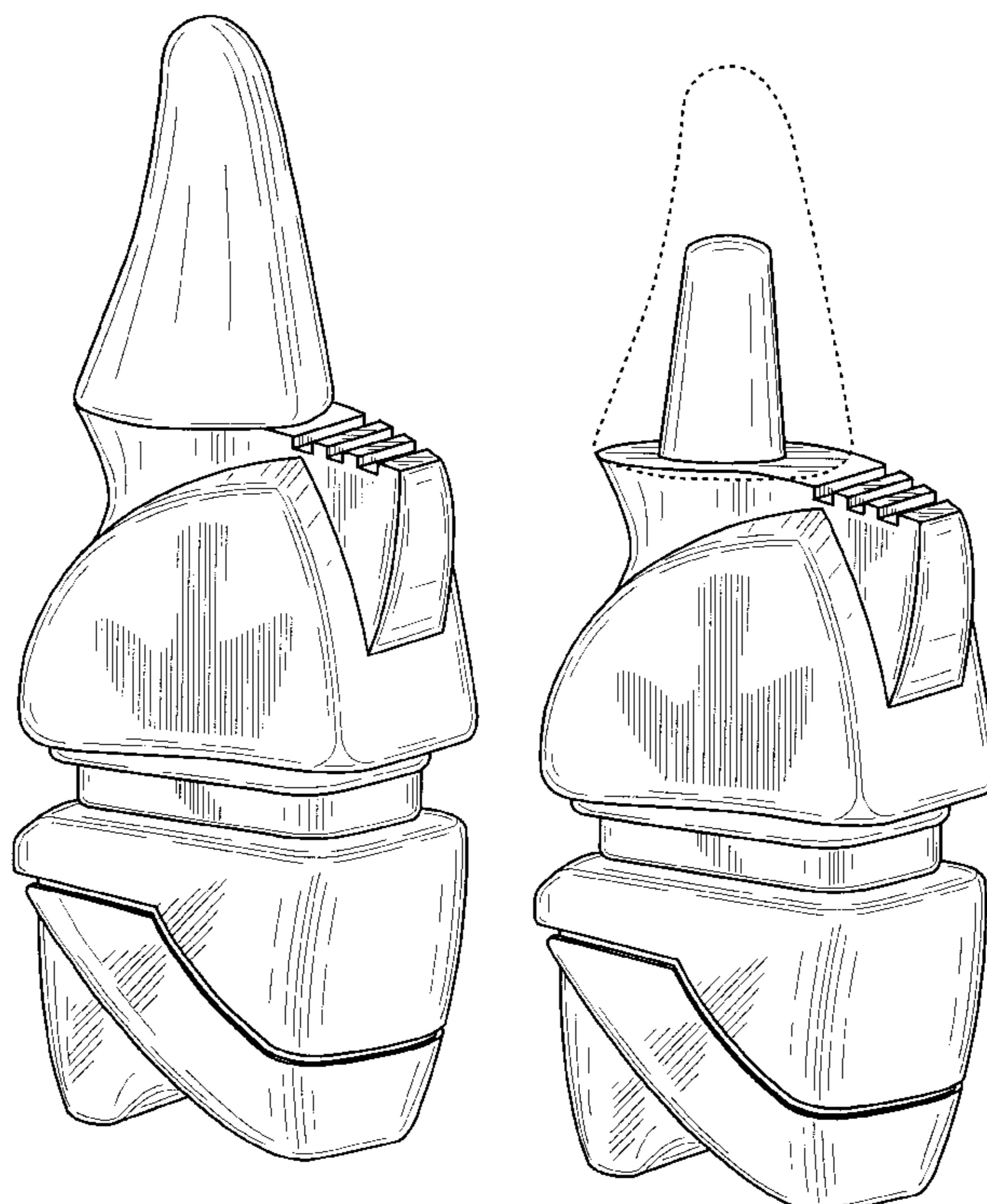

FIG. 1

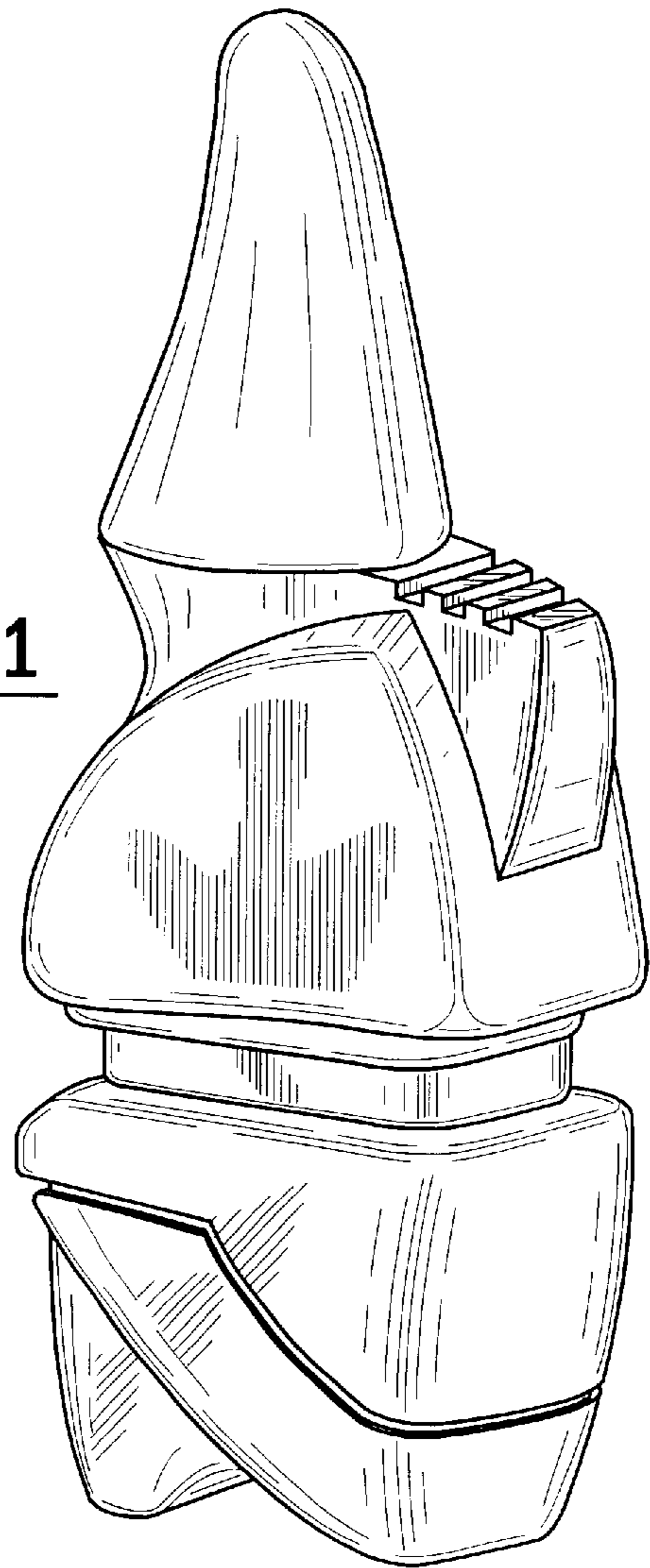
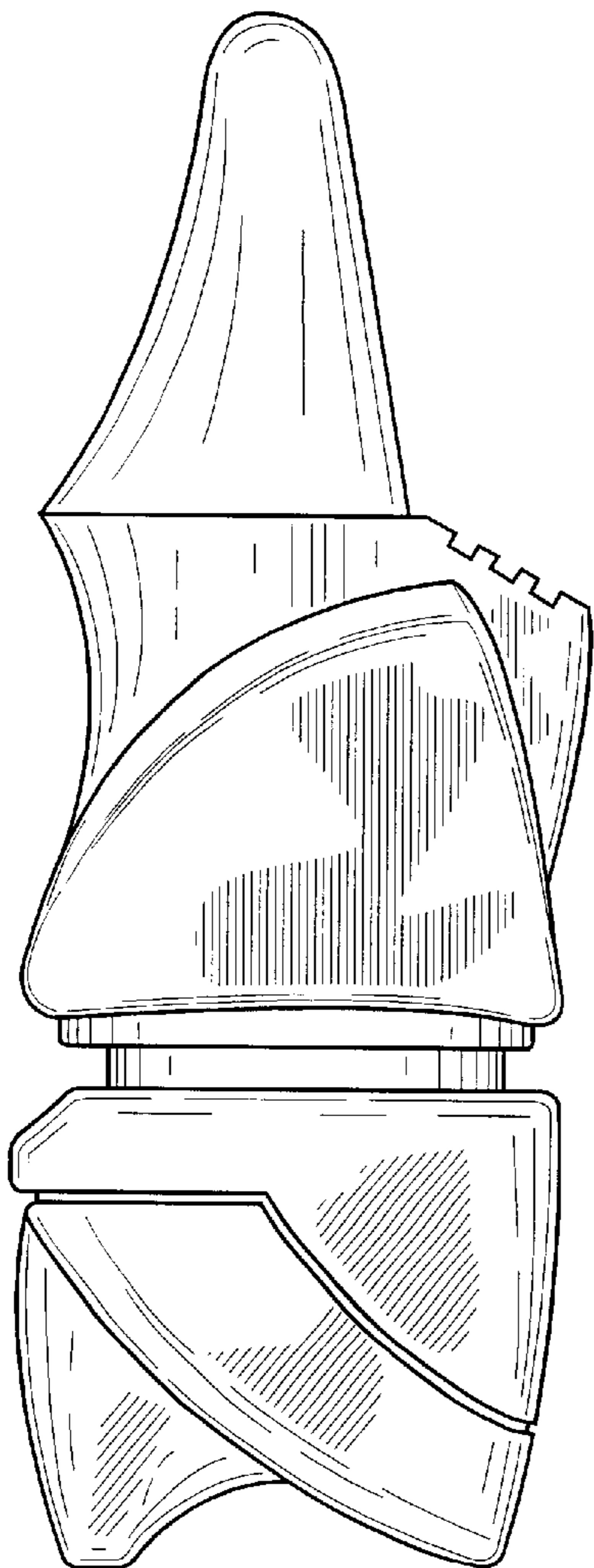

FIG. 2



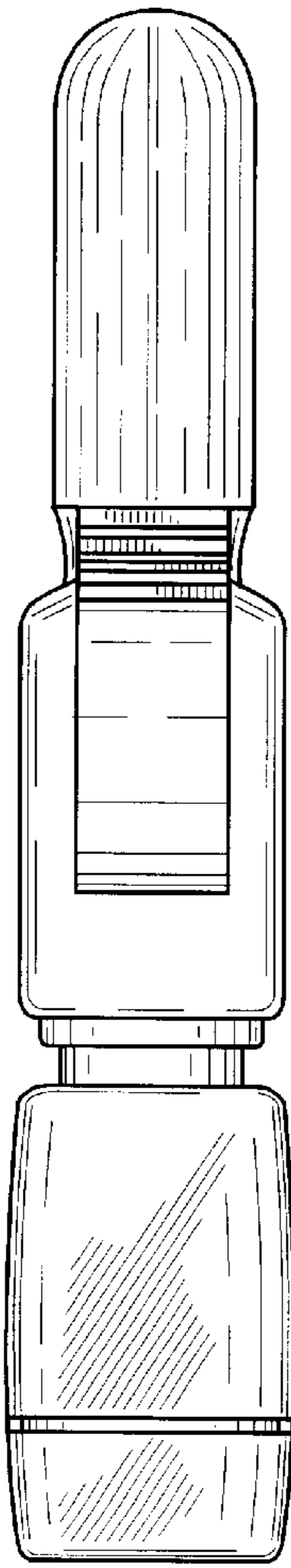

FIG. 3

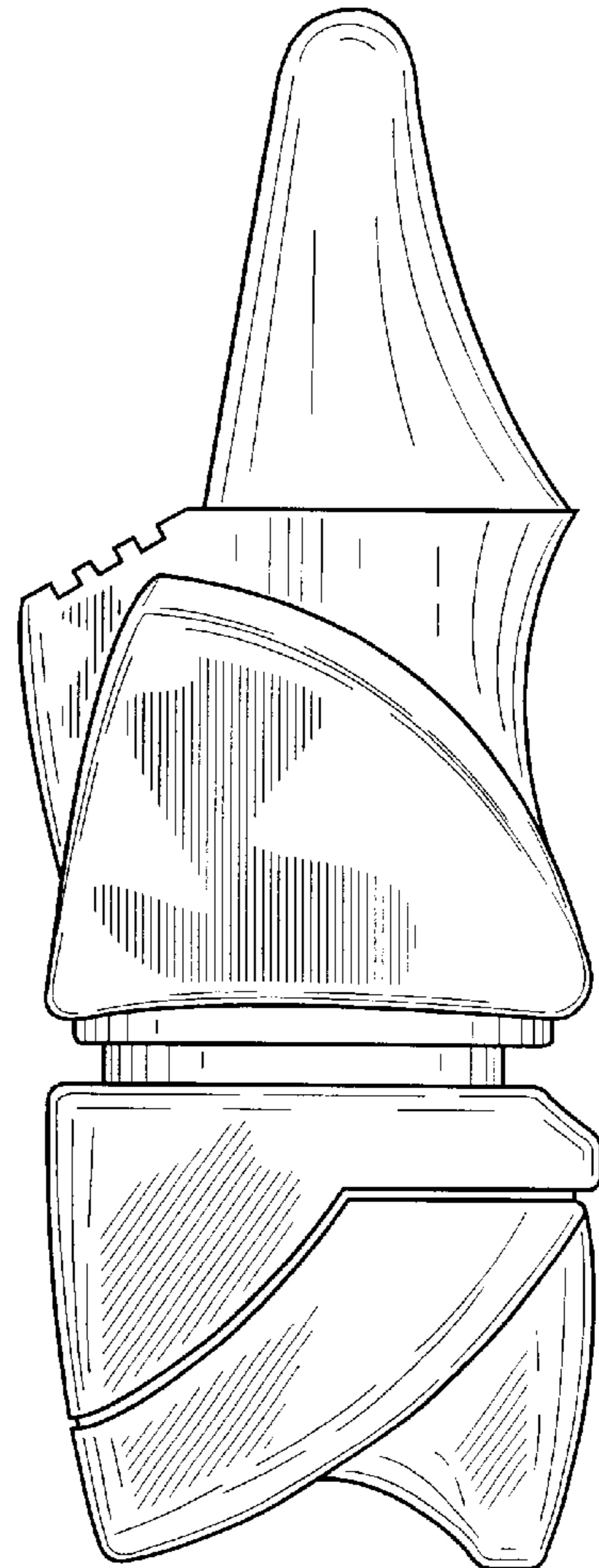

FIG. 4

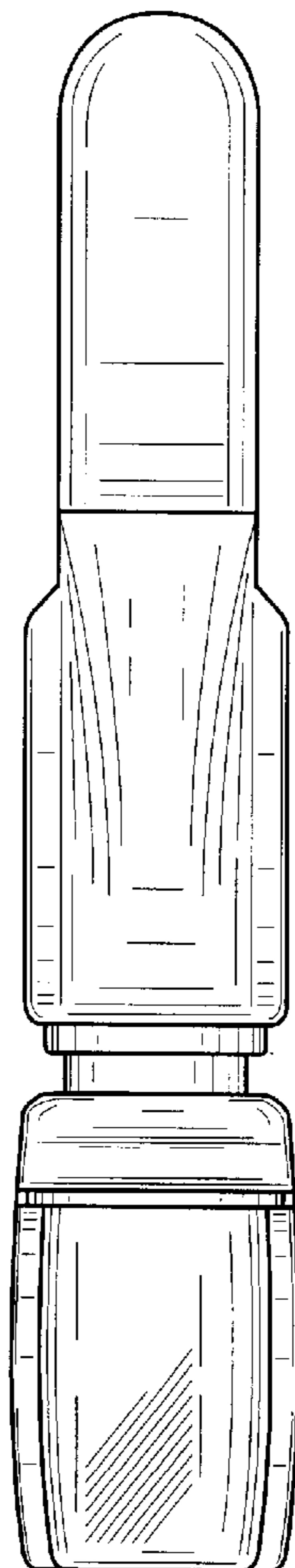

FIG. 5

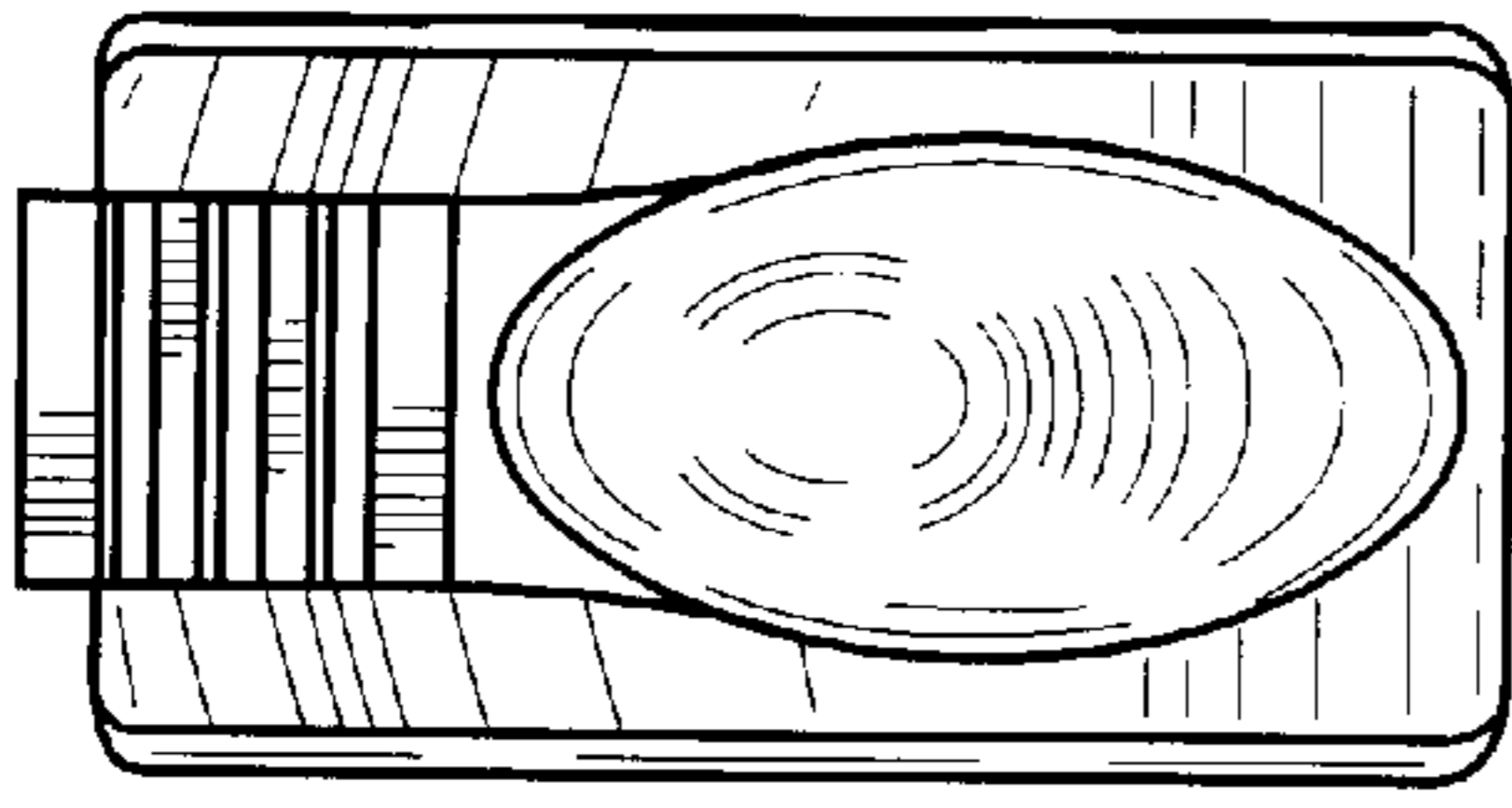

FIG. 6

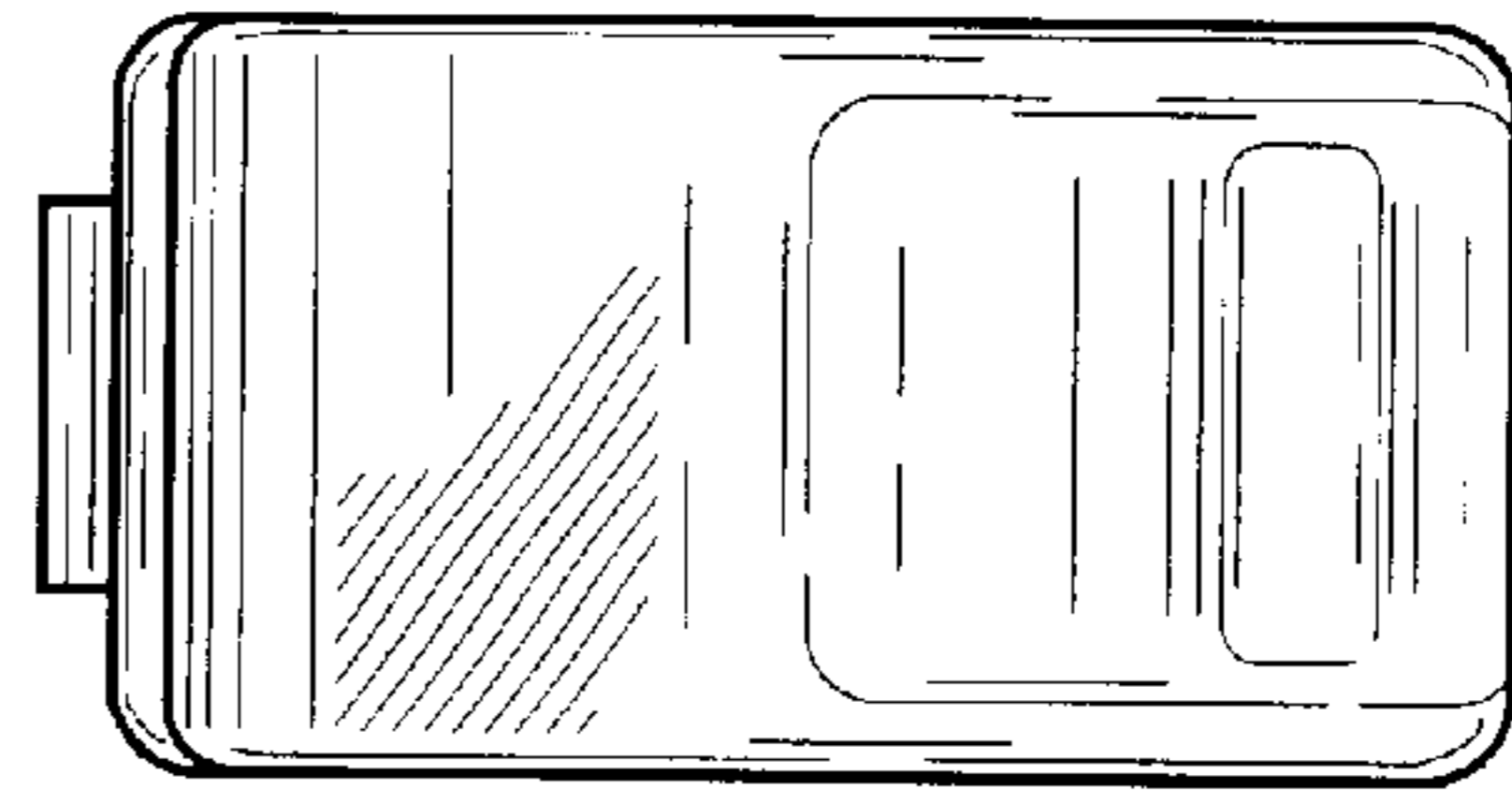
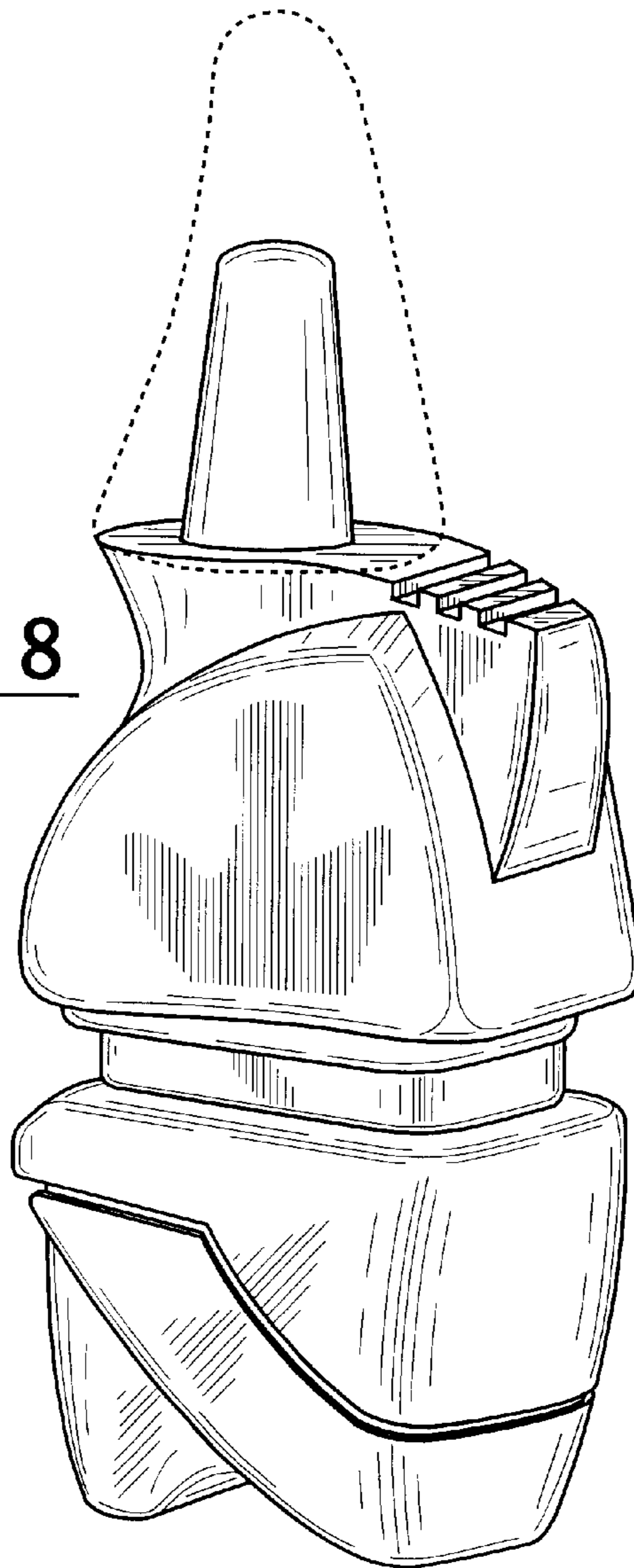

FIG. 7

FIG. 8



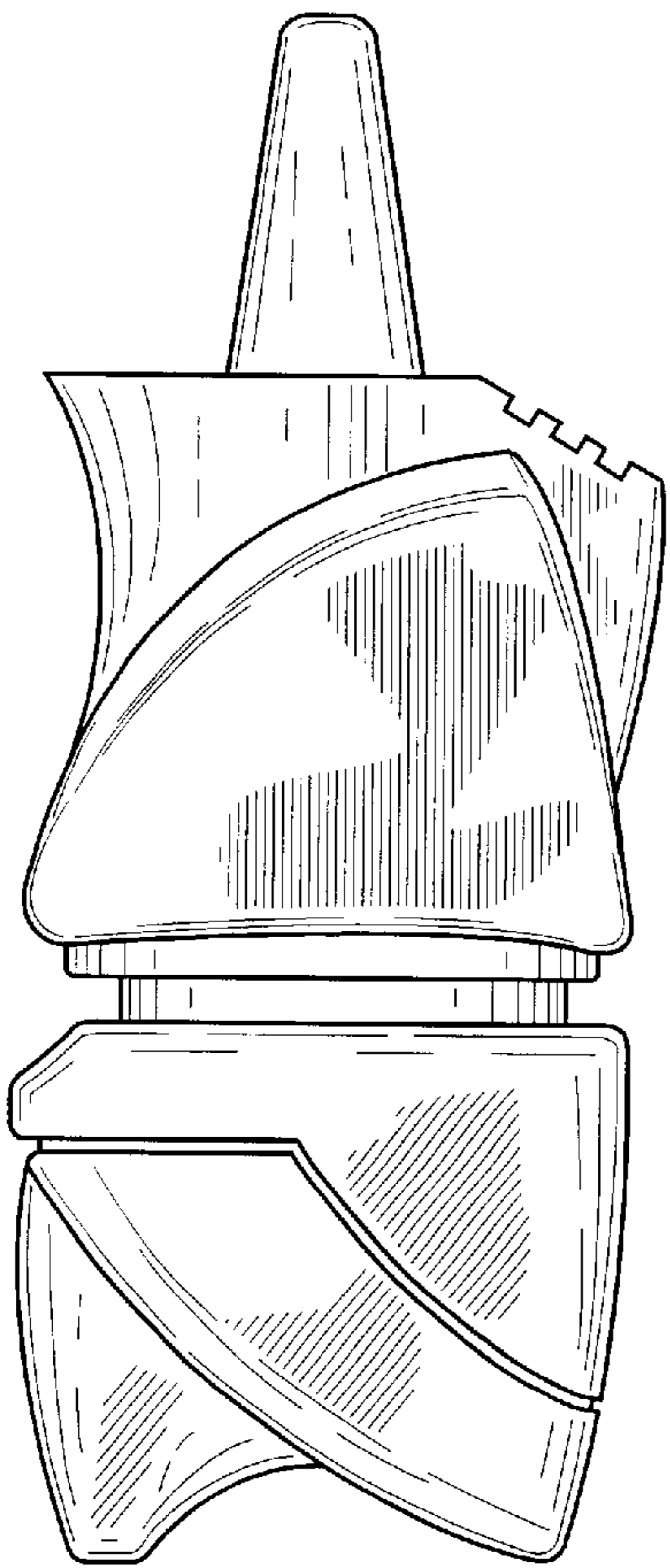

FIG. 9

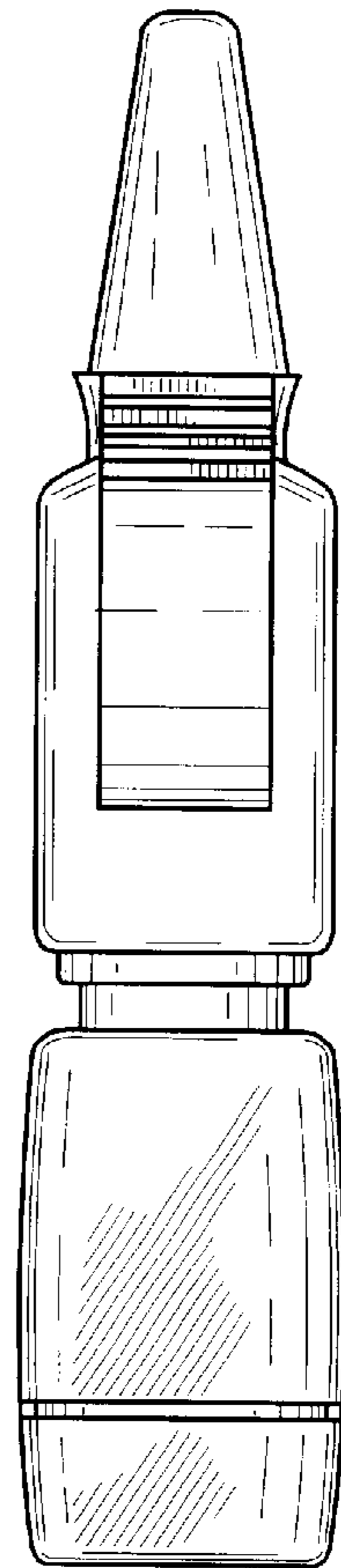

FIG. 10

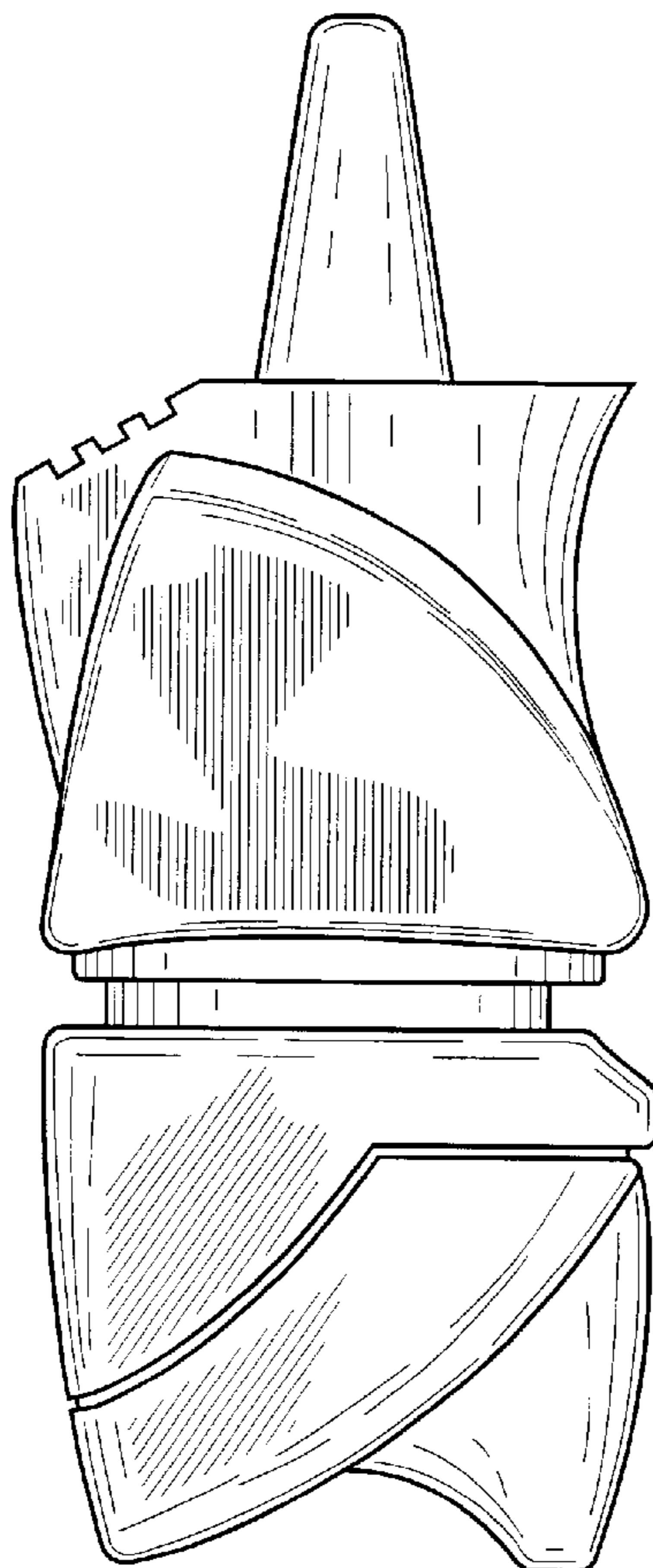

FIG. 11

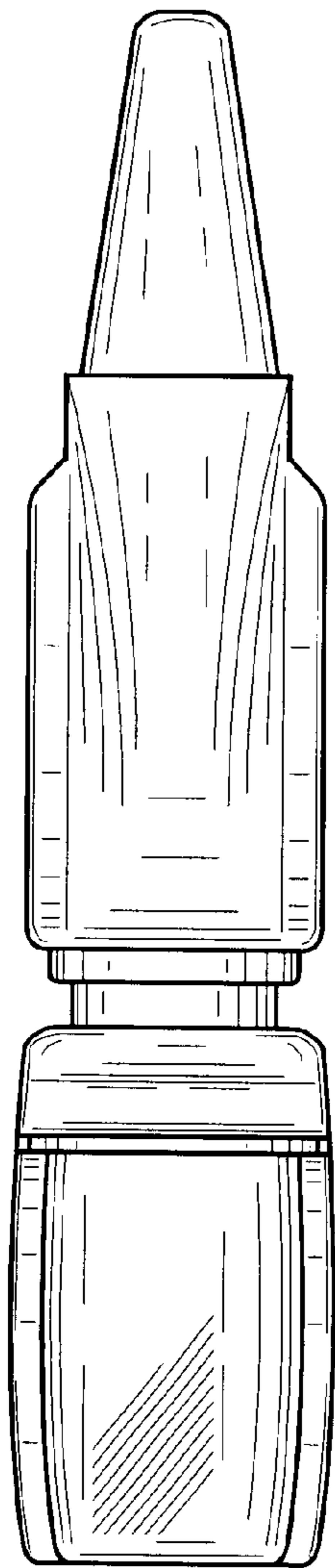

FIG. 12

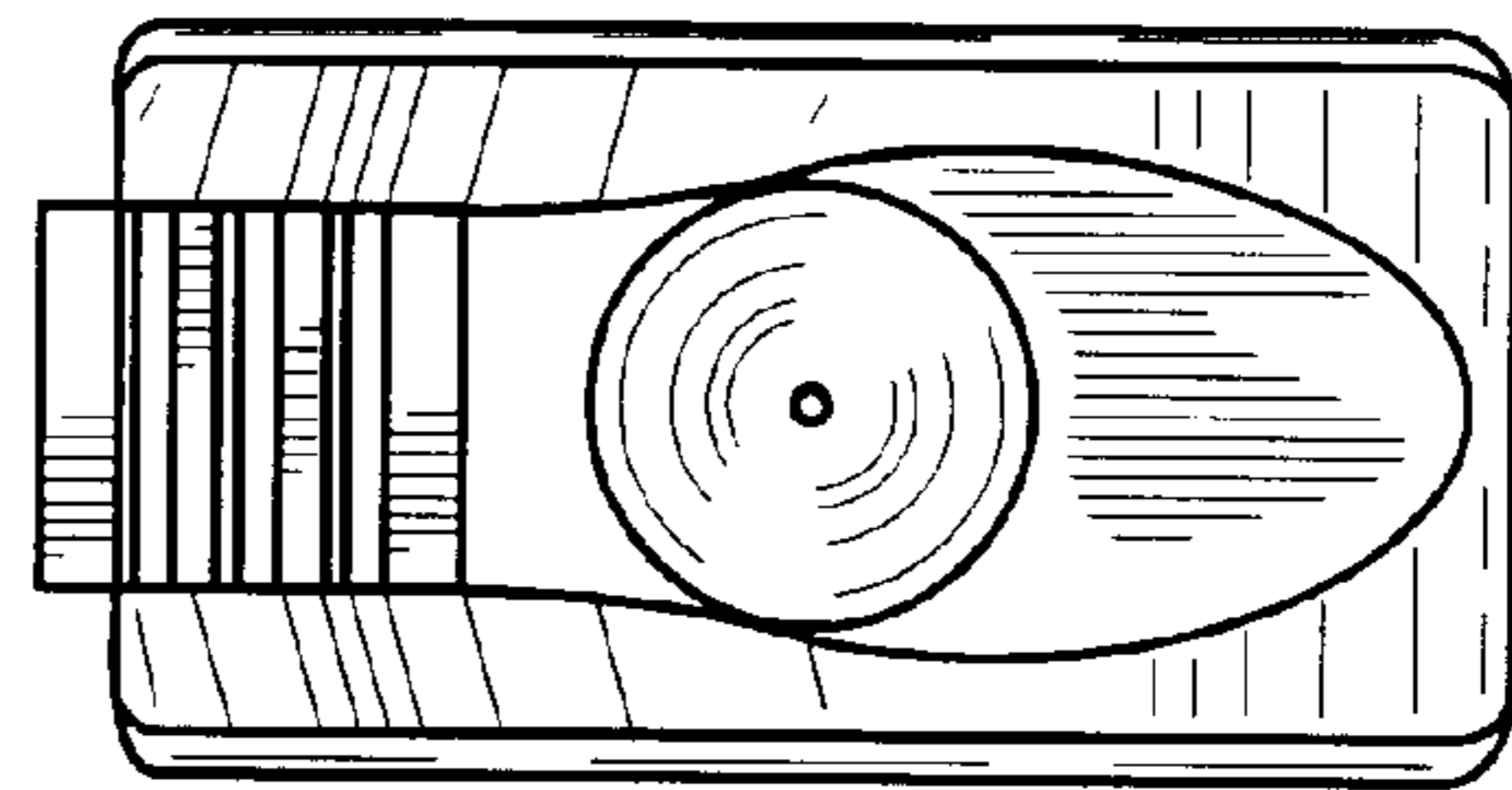

FIG. 13

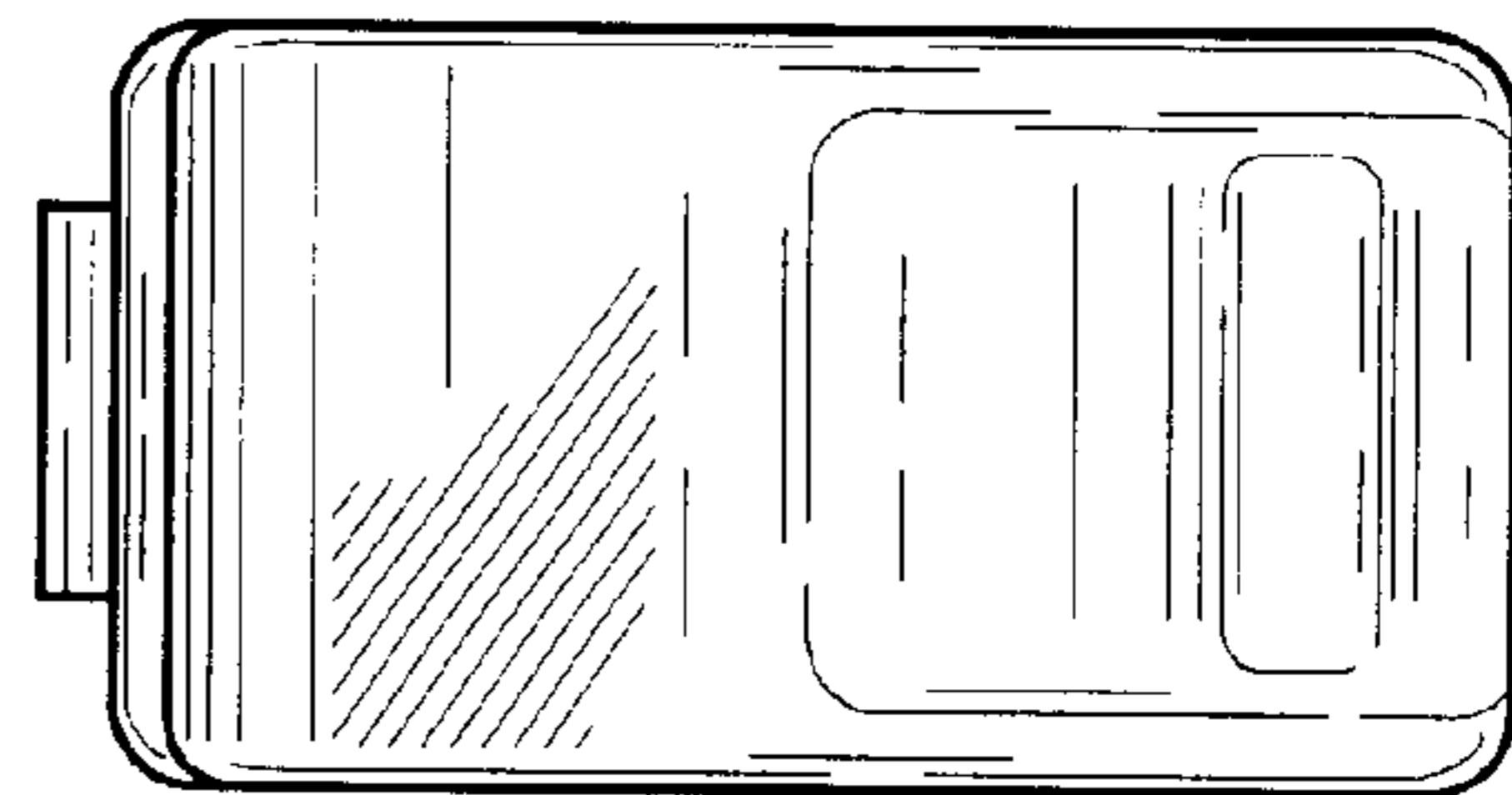

FIG. 14

UNITED STATES PATENT AND TRADEMARK OFFICE  
**CERTIFICATE OF CORRECTION**

PATENT NO. : Des. 483,115 S  
DATED : December 2, 2003  
INVENTOR(S) : Gary Pasternak

Page 1 of 1

It is certified that error appears in the above-identified patent and that said Letters Patent is hereby corrected as shown below:

Title page,

Item [73], Assignee, should read:

-- **Glaxo Group Limited**, Greenford, Middlesex (UK) --.

Signed and Sealed this

Sixth Day of December, 2005

A handwritten signature in black ink on a dotted background. The signature reads "Jon W. Dudas" in a cursive style.

JON W. DUDAS

*Director of the United States Patent and Trademark Office*