



US00D483102S

(12) **United States Design Patent**
Ching

(10) **Patent No.:** **US D483,102 S**

(45) **Date of Patent:** **** Dec. 2, 2003**

(54) **ELECTRIC HEATER**

(75) **Inventor:** **Chan Ching, Taipei Hsien (TW)**

(73) **Assignee:** **Perfect Union Co., Ltd., Taipei Hsien (TW)**

(**) **Term:** **14 Years**

(21) **Appl. No.:** **29/172,932**

(22) **Filed:** **Dec. 20, 2002**

(51) **LOC (7) Cl.** **23-03**

(52) **U.S. Cl.** **D23/335**

(58) **Field of Search** D23/314, 328,
D23/335-8, 340, 341, 370, 377, 380-2;
392/360, 365-9, 373-6; 312/236; 126/110 B,
110 D, 90 A, 92 A

(56) **References Cited**

U.S. PATENT DOCUMENTS

D456,066 S * 4/2002 Ching D23/337
D456,499 S * 4/2002 Ching D23/335

D462,429 S * 9/2002 Gao D23/335
D462,753 S * 9/2002 Gao D23/335
6,480,672 B1 * 11/2002 Rosenzweig et al. 392/365
D467,324 S * 12/2002 Ching D23/335

* cited by examiner

Primary Examiner—B. J. Bullock

(74) *Attorney, Agent, or Firm*—Troxell Law Office PLLC

(57) **CLAIM**

The ornamental design for an electric heater, as shown and described.

DESCRIPTION

FIG. 1 is a top front and left side perspective view of an electric heater showing my new design;
FIG. 2 is a front elevational view thereof;
FIG. 3 is a rear elevational view thereof;
FIG. 4 is a left side elevational view thereof;
FIG. 5 is a right side elevational view thereof;
FIG. 6 is a top plan view thereof; and,
FIG. 7 is a bottom plan view thereof.

1 Claim, 7 Drawing Sheets

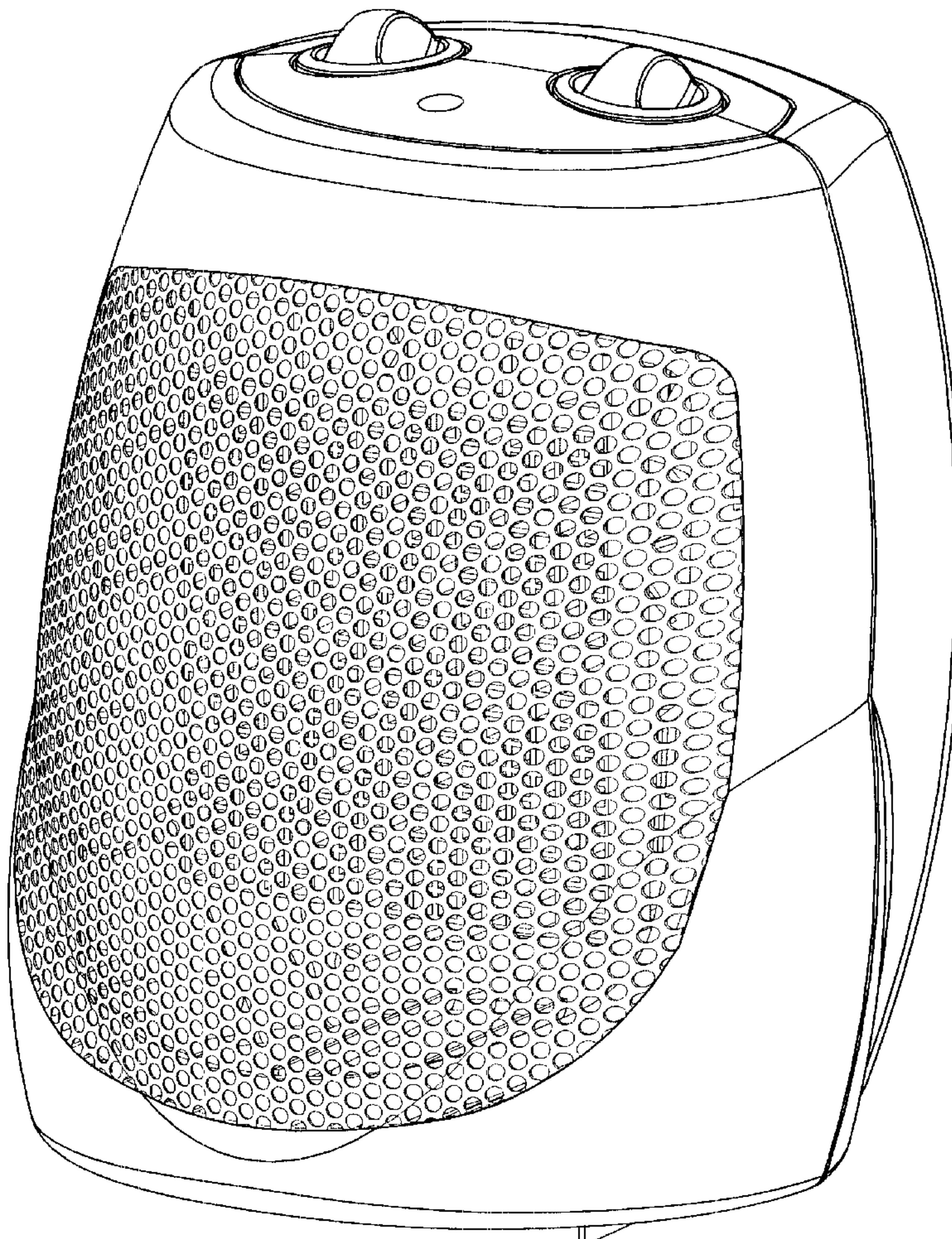

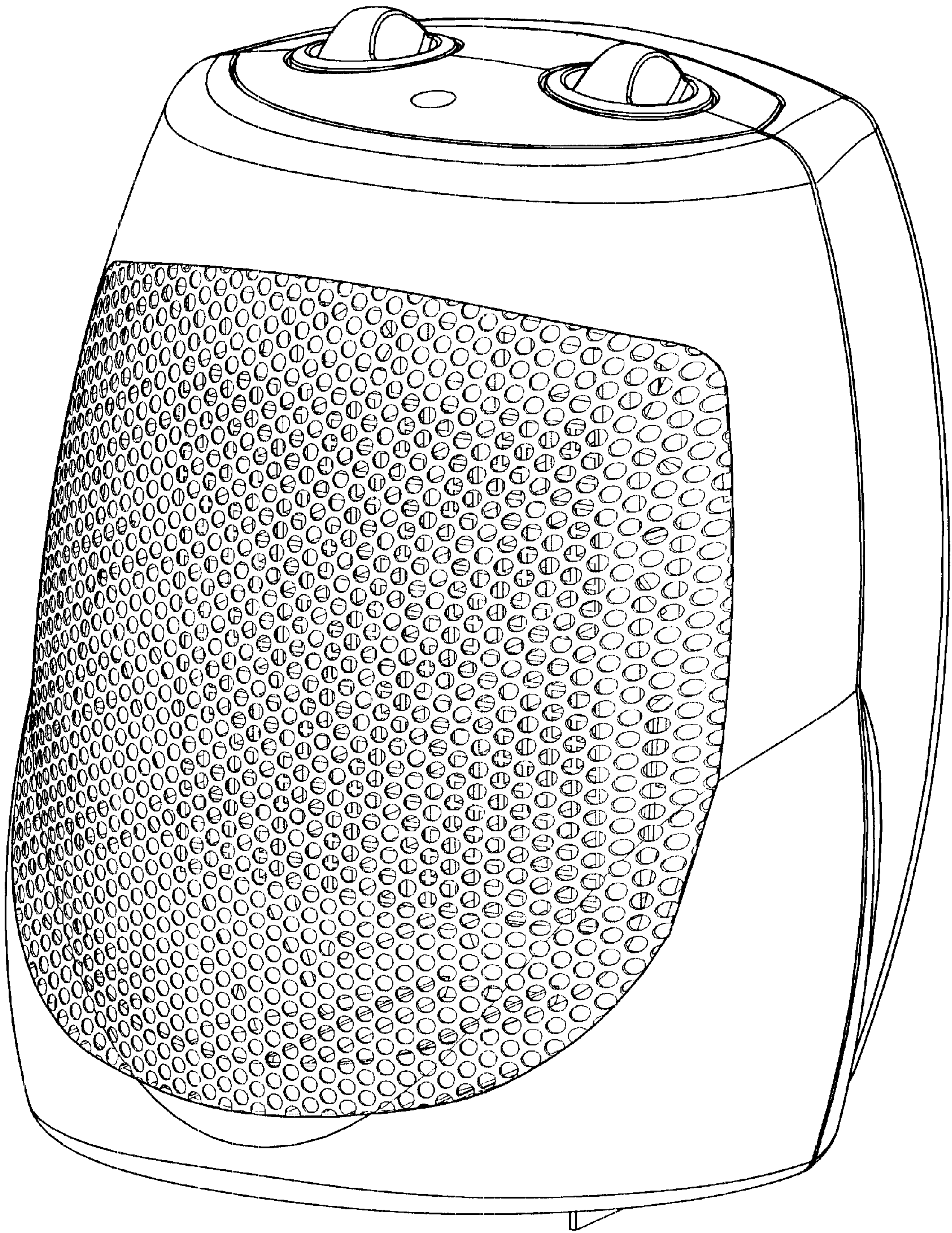

Fig. 1

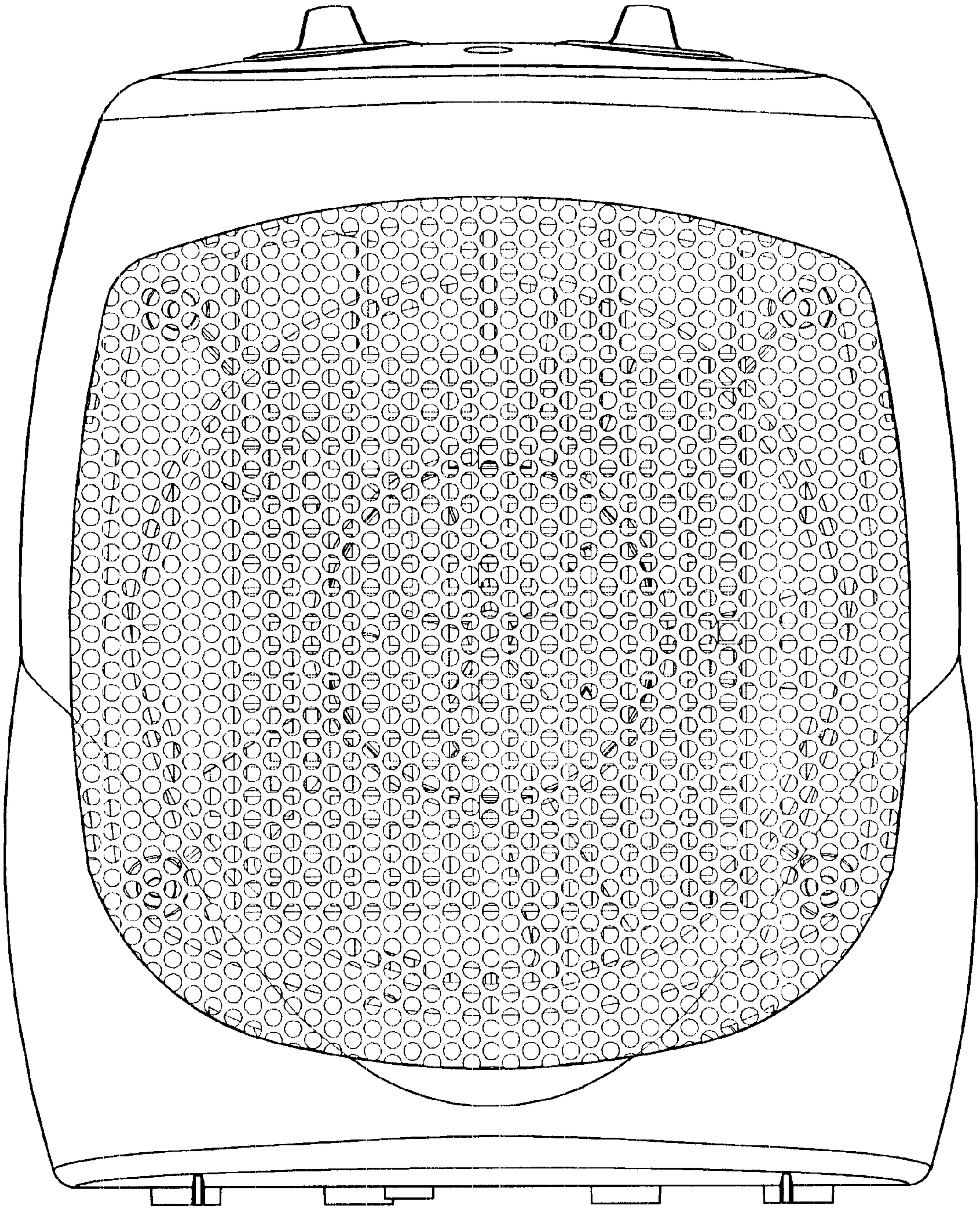

Fig. 2

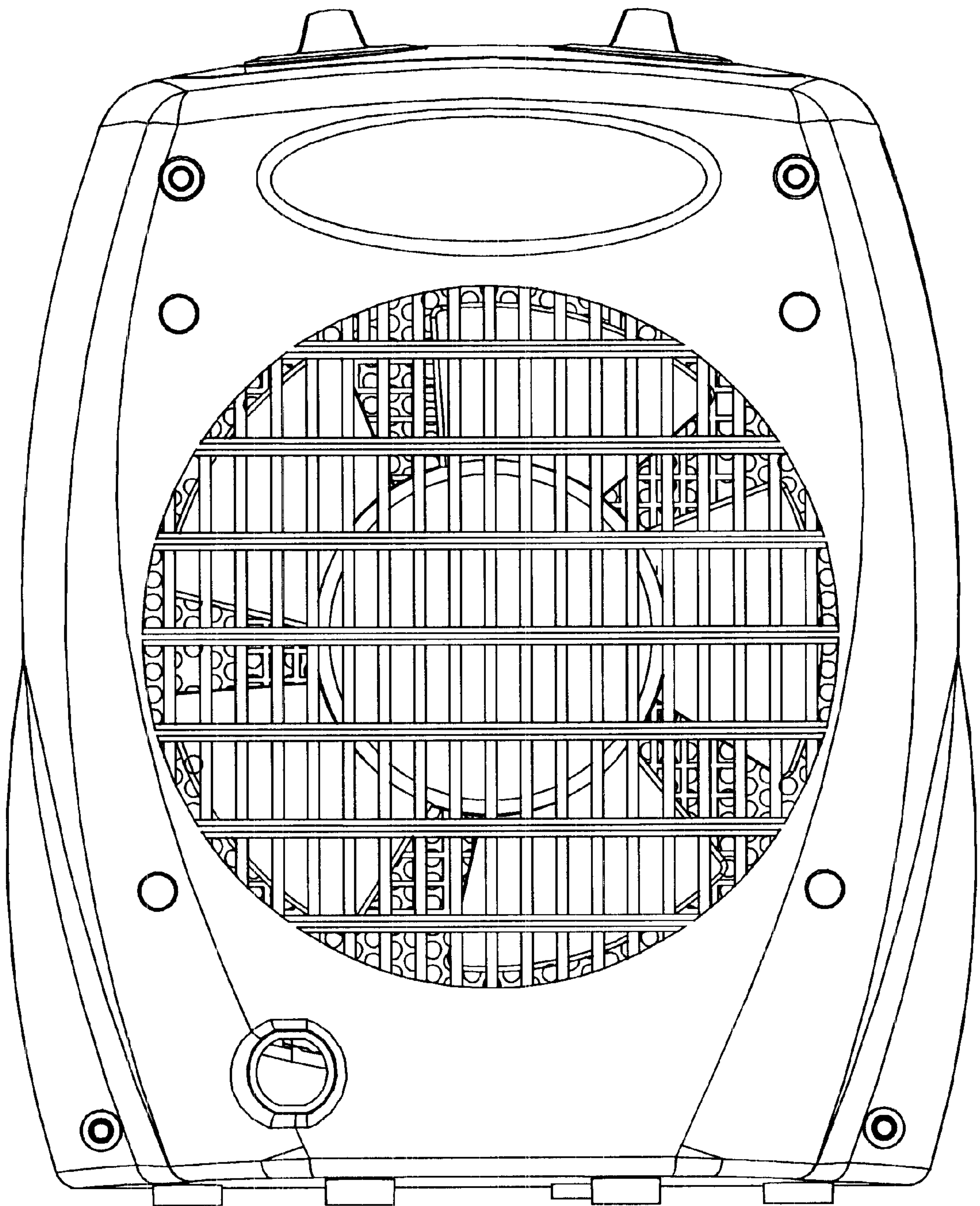

Fig. 3

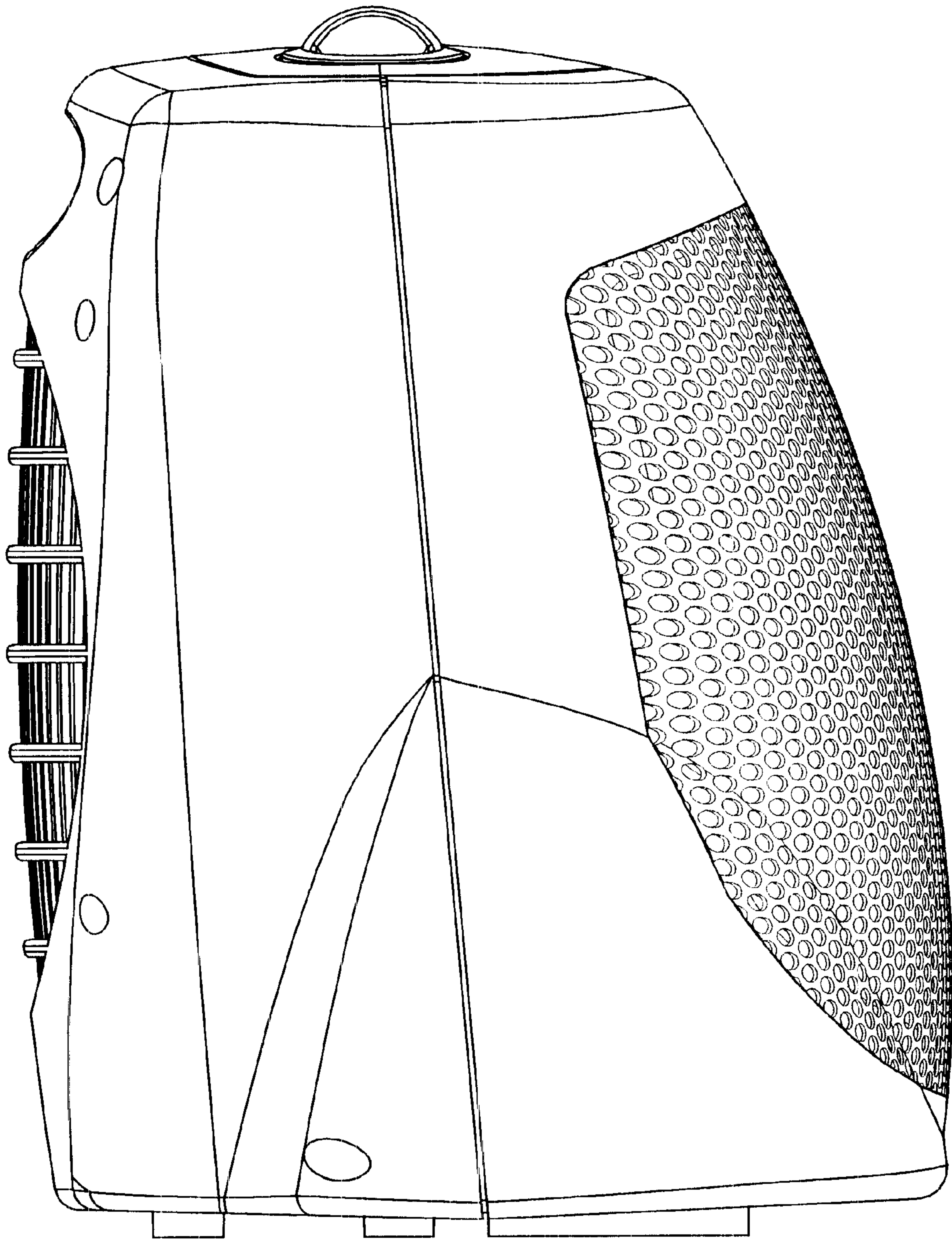

Fig. 4

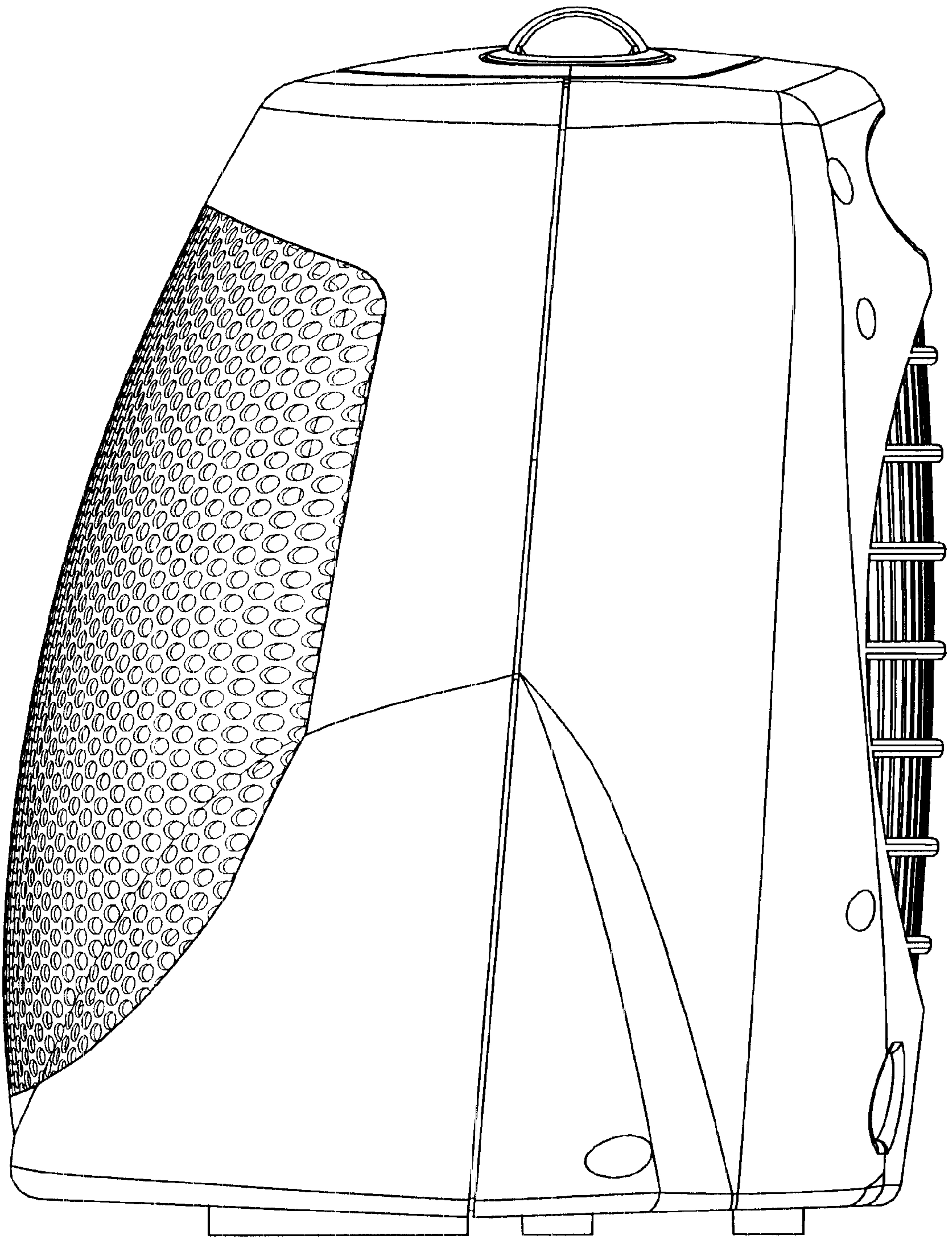

Fig. 5

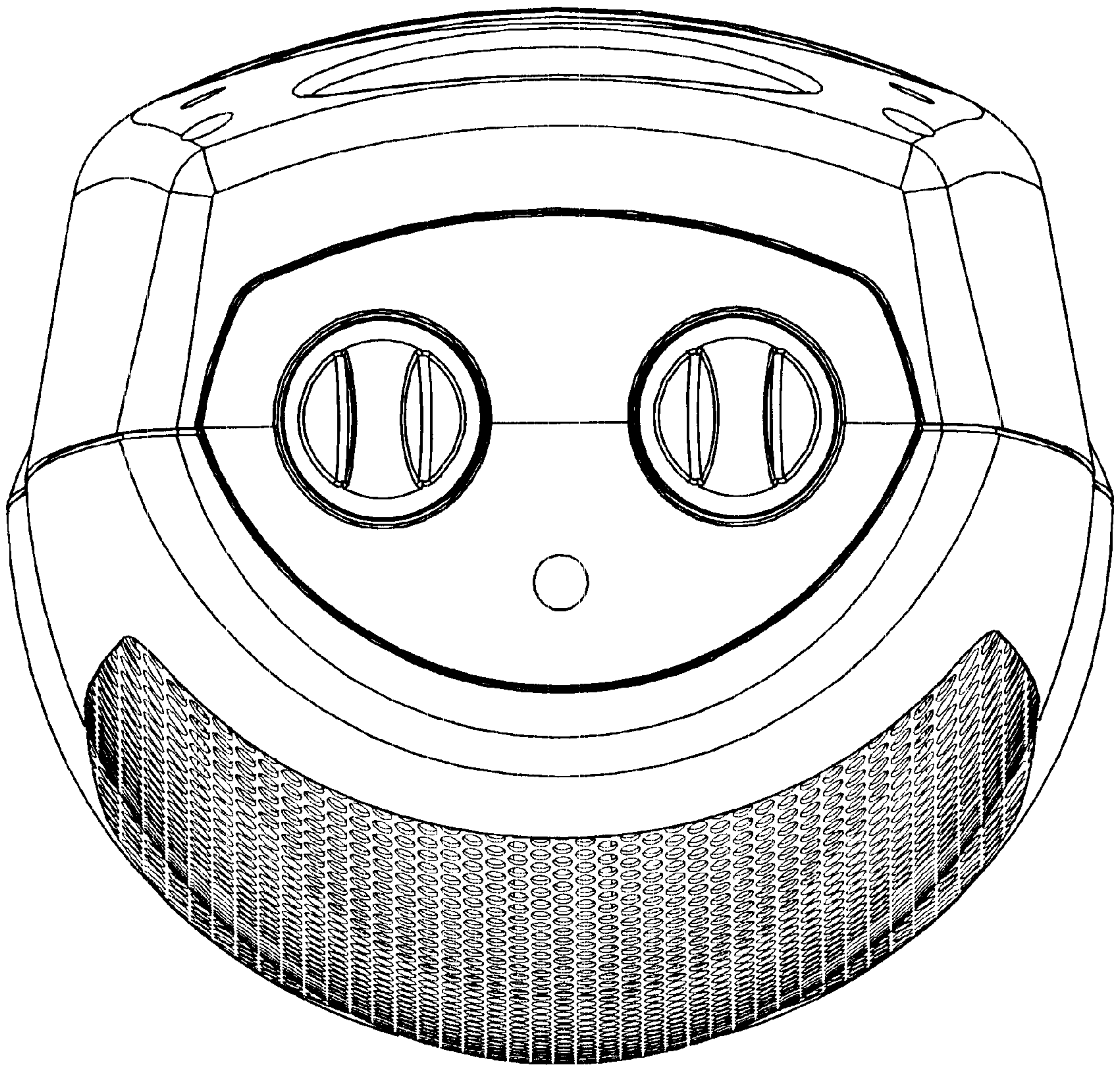

Fig. 6

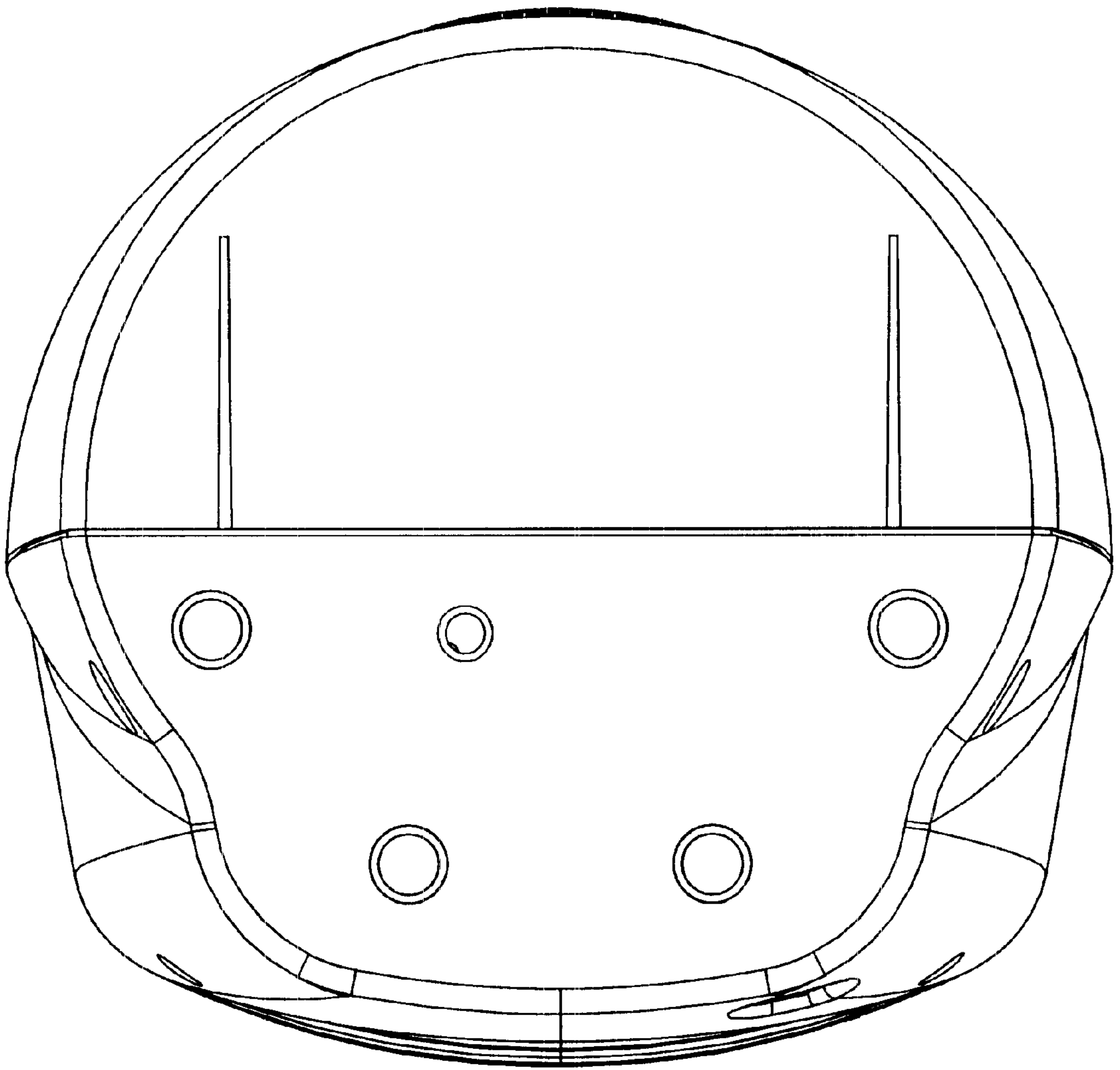

Fig. 7