



US00D483071S

(12) **United States Design Patent**  
**Chen**

(10) **Patent No.:** **US D483,071 S**

(45) **Date of Patent:** **\*\* Dec. 2, 2003**

(54) **PAPER TRAY**

(75) **Inventor:** **Peter Chen**, West Windsor, NJ (US)

(73) **Assignee:** **Officemate International Corp.**,  
Edison, NJ (US)

(\*\*) **Term:** **14 Years**

(21) **Appl. No.:** **29/166,300**

(22) **Filed:** **Aug. 23, 2002**

(51) **LOC (7) Cl.** ..... **19-02**

(52) **U.S. Cl.** ..... **D19/92; D19/86**

(58) **Field of Search** ..... D19/35, 36, 65,  
D19/75, 78, 86, 91, 92, 95, 99, 100; 206/215,  
555, 556, 557; 211/10, 11, 13.1, 126.1,  
50, 126.13, 126.16, 55, 52, 126.2-126.7,  
126.12

(56) **References Cited**

**U.S. PATENT DOCUMENTS**

2,627,343	A	*	2/1953	Gallagher	.....	206/555
D261,904	S	*	11/1981	Polhemus	.....	D19/92
4,657,148	A	*	4/1987	Heng	.....	211/126.12
4,887,724	A	*	12/1989	Pielechowski et al.	.....	211/11
4,907,703	A	*	3/1990	Alger et al.	.....	211/10
D314,398	S	*	2/1991	Aaldenberg et al.	.....	D19/92

D317,467	S	*	6/1991	Kheng	.....	D19/92
D319,473	S	*	8/1991	Aaldenberg et al.	.....	D19/92
D348,284	S	*	6/1994	Thorud et al.	.....	D19/92

**OTHER PUBLICATIONS**

Jacobs Gardner Office Products, ©2000, see p. 472, circled desk tray, upper left.\*  
Jacobs Gardner Office Products, ©2000, see p. 484, circled desk tray, top center.\*

\* cited by examiner

*Primary Examiner*—Martie K. Holtje

(74) *Attorney, Agent, or Firm*—Daniel Kirshner, Esq.

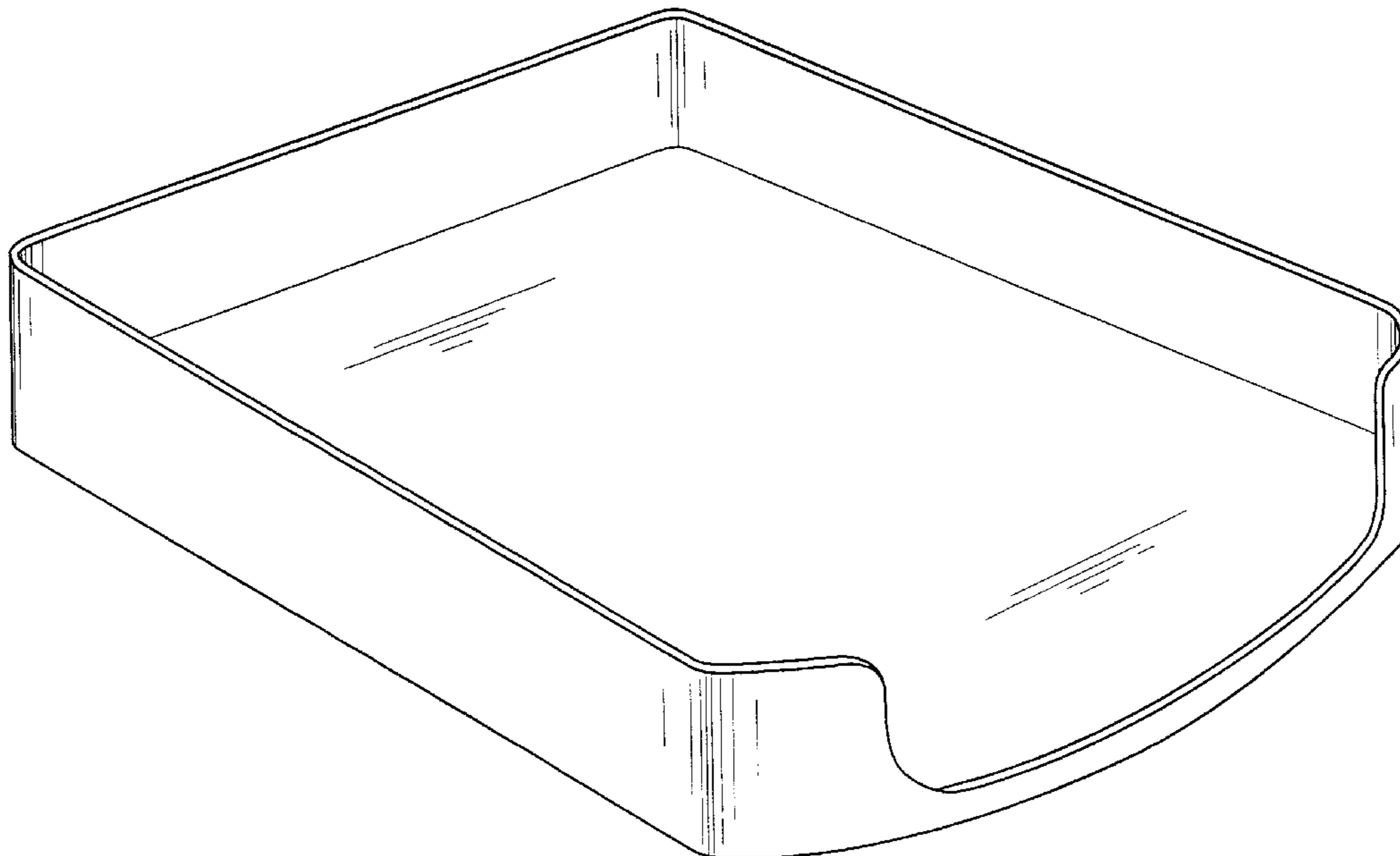
(57) **CLAIM**

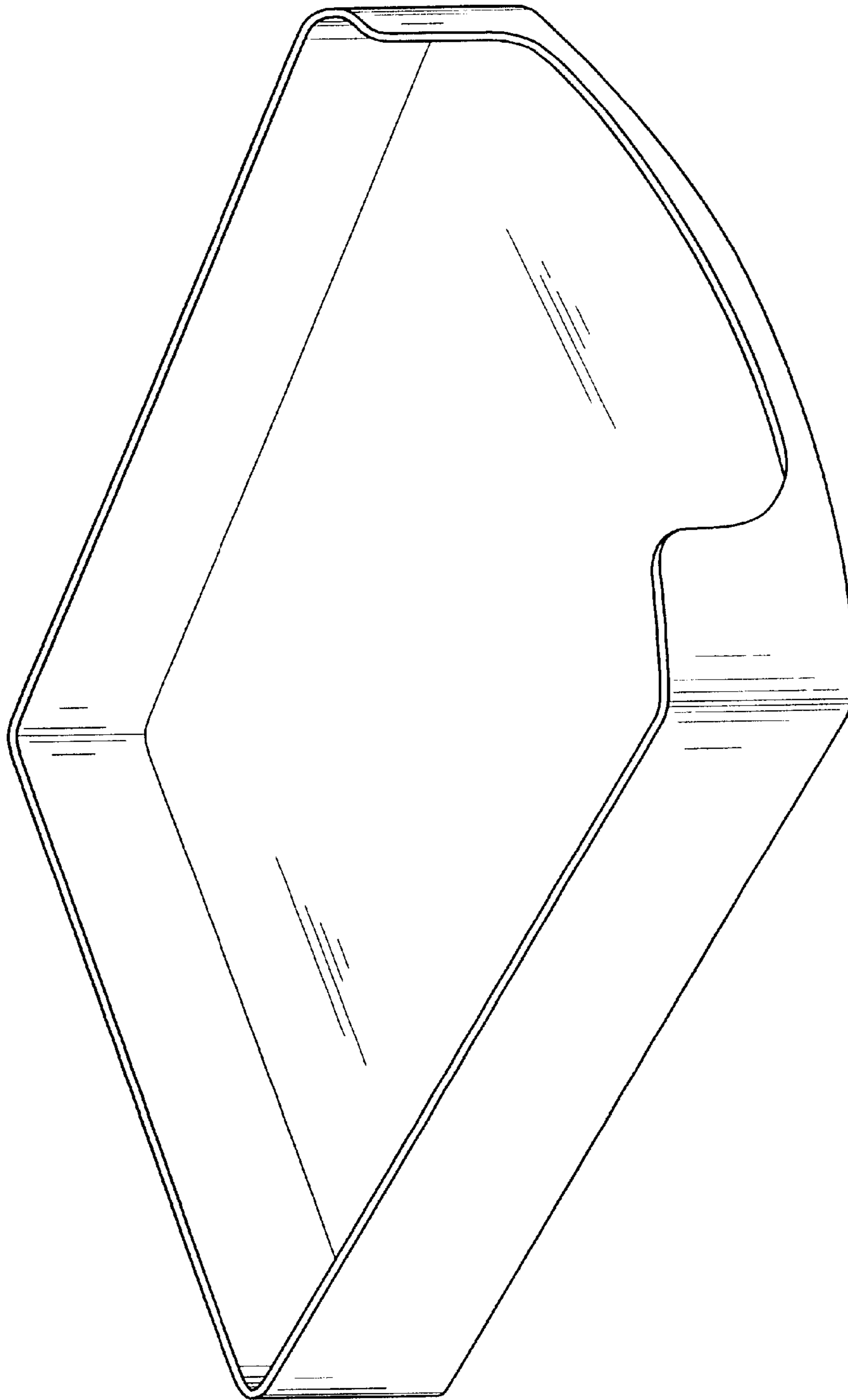
The ornamental design for the paper tray, as shown.

**DESCRIPTION**

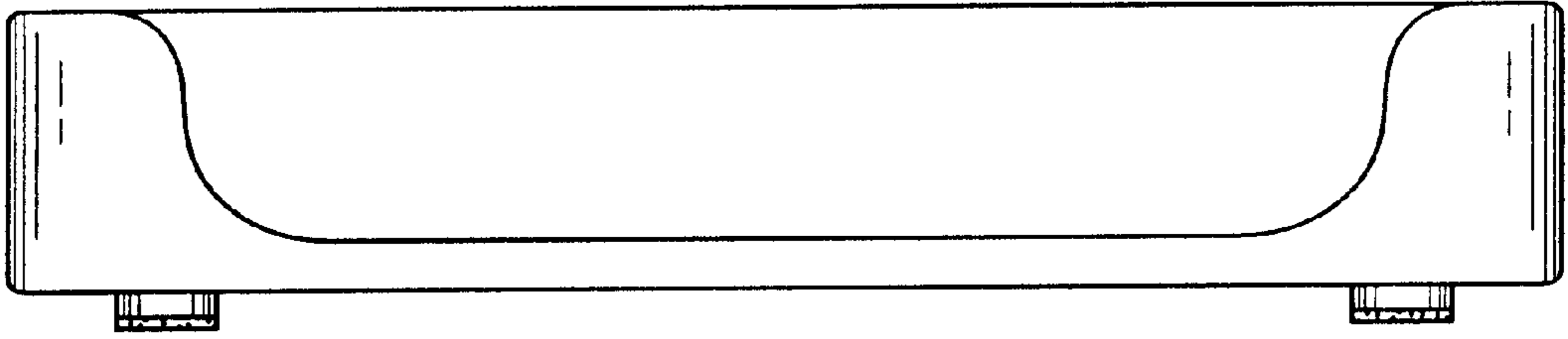
FIG. 1 is a front perspective view of the paper tray showing the design;  
FIG. 2 is a front elevational view thereof;  
FIG. 3 is a rear elevational view thereof;  
FIG. 4 is a right side elevational view thereof;  
FIG. 5 is a left side elevational view thereof;  
FIG. 6 is a top plan view thereof; and,  
FIG. 7 is a bottom plan view thereof.

**1 Claim, 4 Drawing Sheets**

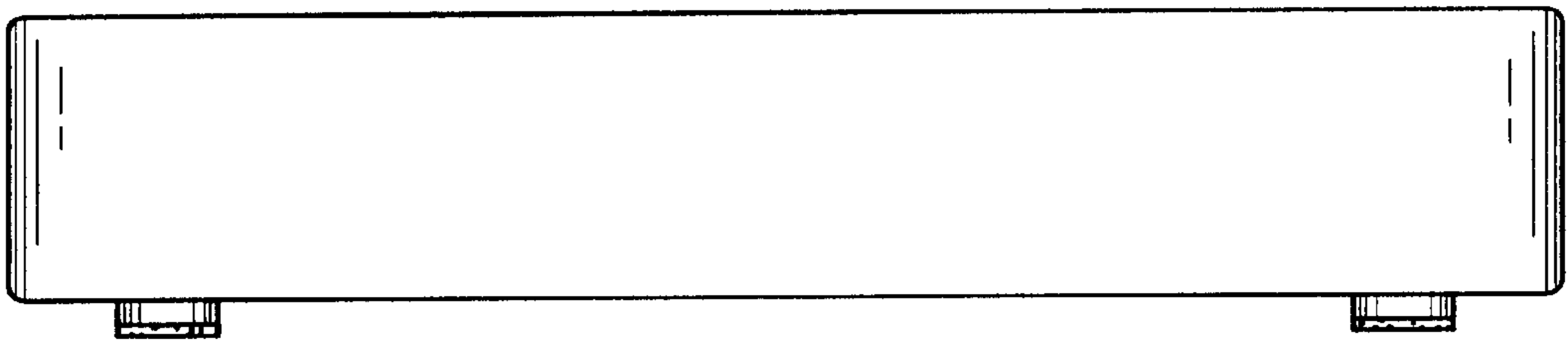




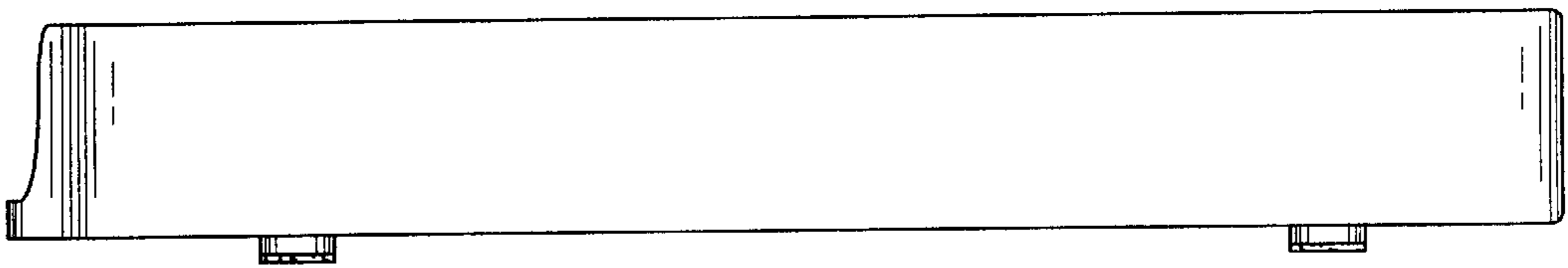
**FIG. 1**



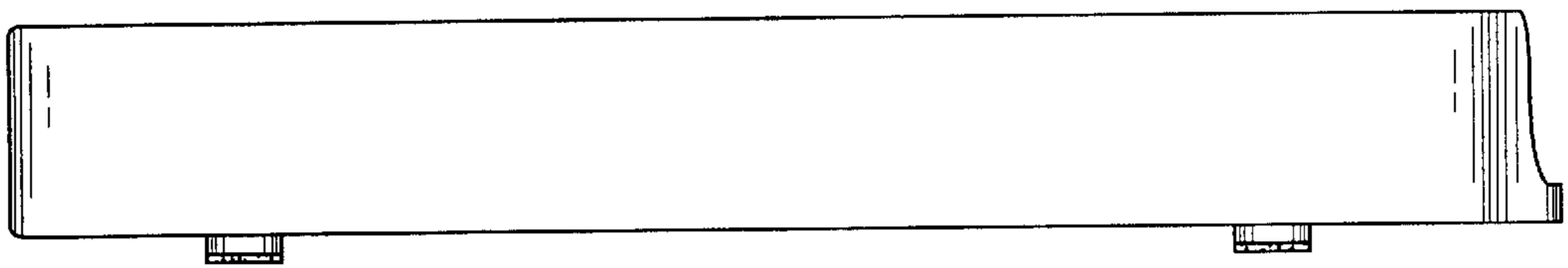
*FIG. 2*



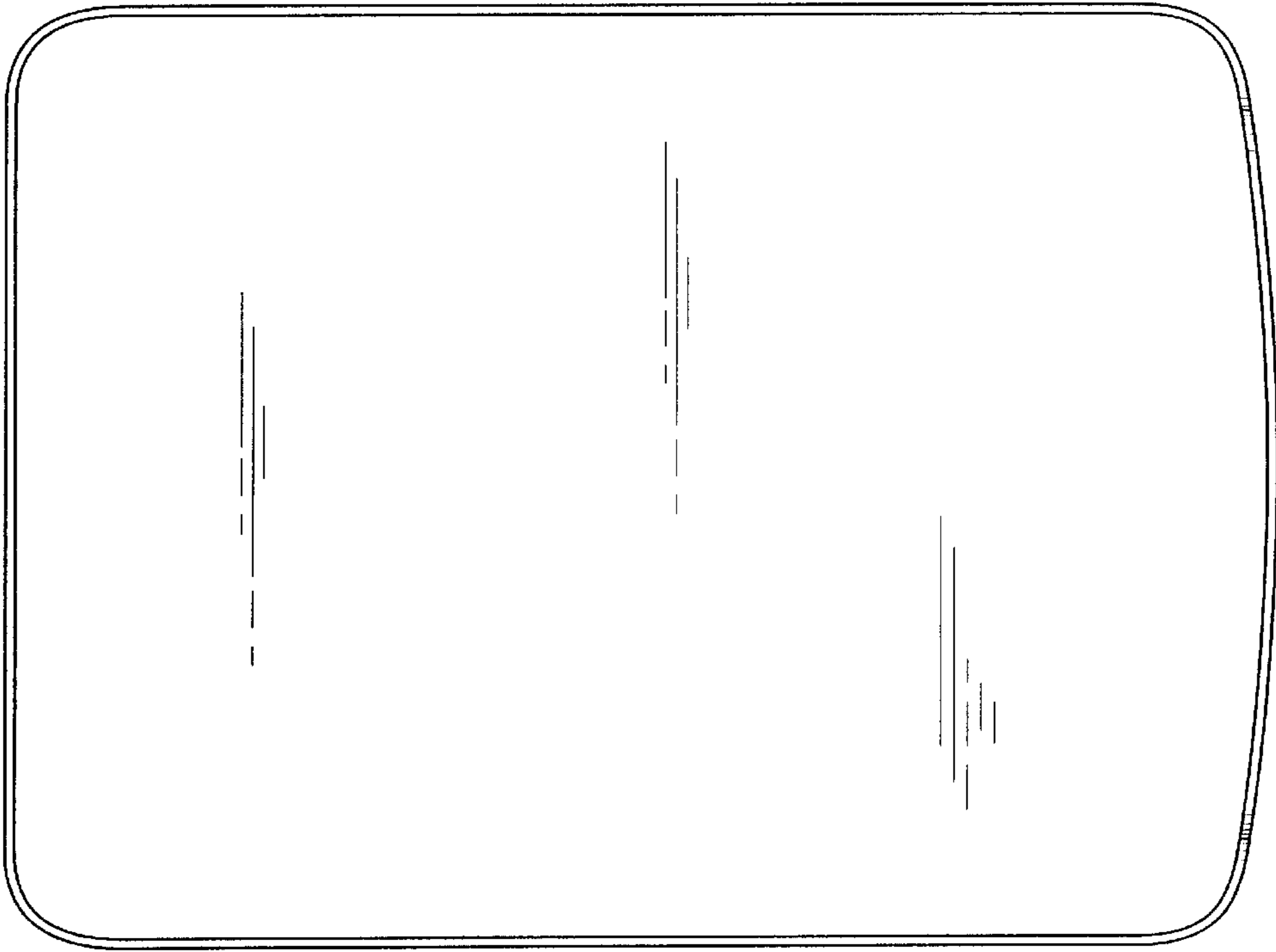
*FIG. 3*



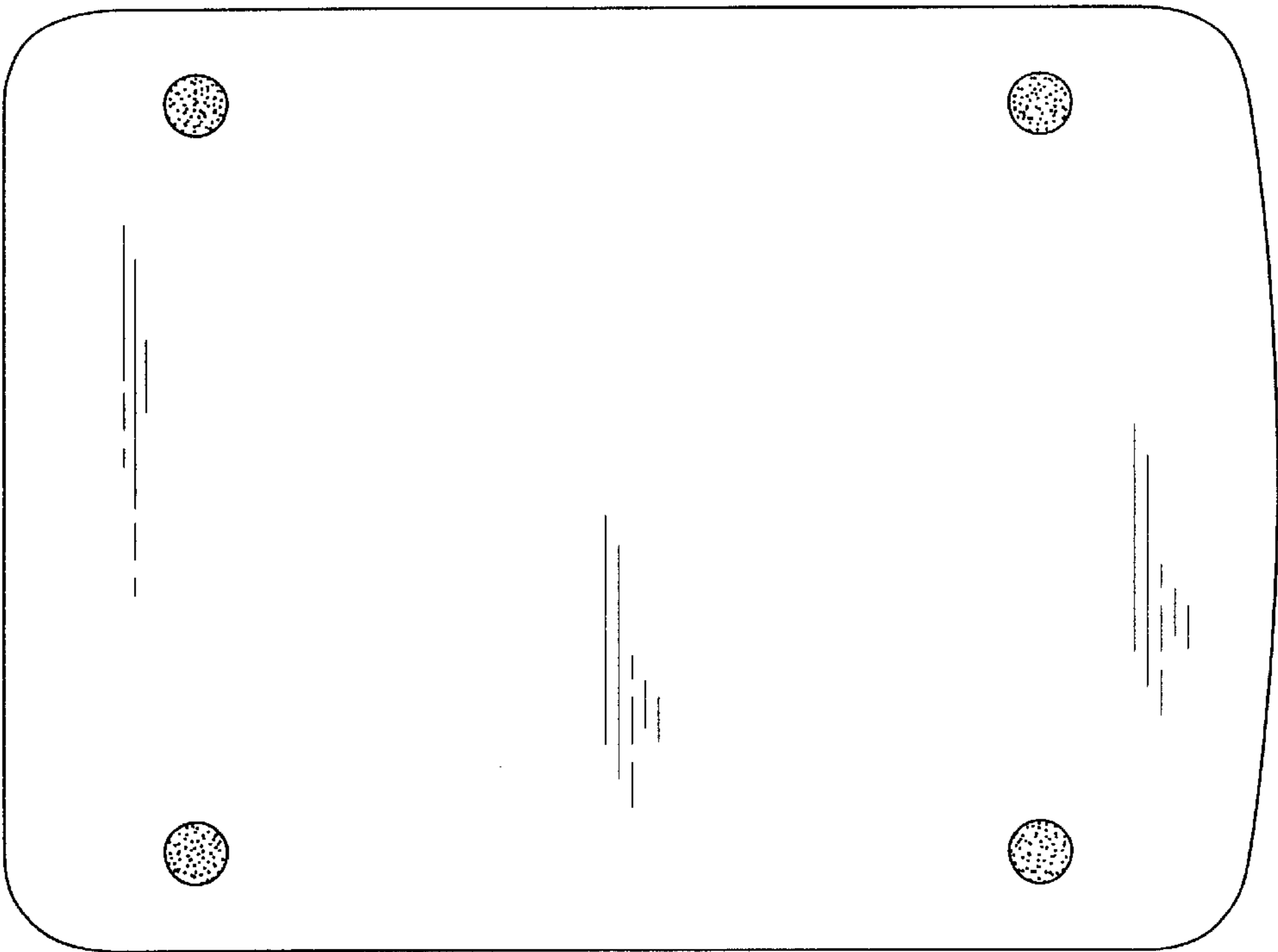
*FIG. 4*



*FIG. 5*



*FIG. 6*



*FIG. 7*