



US00D482932S

(12) **United States Design Patent**  
**Sher**

(10) **Patent No.:** **US D482,932 S**

(45) **Date of Patent:** **\*\* Dec. 2, 2003**

(54) **LIGHTER**

(75) **Inventor:** **Tak Chi Sher, Quarry Bay (HK)**

(73) **Assignee:** **Polycity Enterprise Limited (HK)**

(\*\*) **Term:** **14 Years**

(21) **Appl. No.:** **29/183,104**

(22) **Filed:** **Jun. 4, 2003**

(51) **LOC (7) Cl.** ..... **07-99**

(52) **U.S. Cl.** ..... **D7/416**

(58) **Field of Search** ..... D7/416, 417; D27/147,  
D27/156; 431/13, 153, 127, 128, 255, 254,  
91, 345; 126/414, 229, 401, 253

(56) **References Cited**

**U.S. PATENT DOCUMENTS**

D327,813 S	*	7/1992	Shike et al.	.....	D7/416
5,326,256 A	*	7/1994	Shike et al.	.....	431/255
D377,736 S	*	2/1997	Iwagaki et al.	.....	D7/416
5,865,614 A	*	2/1999	Hsu	.....	431/255
D407,945 S	*	4/1999	Moran, IV	.....	D7/416
D421,876 S	*	3/2000	Hsu	.....	D7/416

D435,397 S	*	12/2000	Sung	.....	D7/416
D467,120 S	*	12/2002	Yu	.....	D7/416
D468,586 S	*	1/2003	Saito et al.	.....	D7/416
D472,765 S	*	4/2003	Deffner	.....	D7/416
D473,103 S	*	4/2003	Sung	.....	D7/416
D475,889 S	*	6/2003	Deffner	.....	D7/416

\* cited by examiner

*Primary Examiner*—M. N. Pandozzi

(74) *Attorney, Agent, or Firm*—Beyer Weaver & Thomas LLP

(57) **CLAIM**

The ornamental design for a lighter, substantially as shown and described.

**DESCRIPTION**

FIG. 1 is a front perspective view of lighter;  
FIG. 2 is a left side view of the lighter;  
FIG. 3 is a right side view of the lighter;  
FIG. 4 is a top plan view of the lighter;  
FIG. 5 is a bottom view of the lighter;  
FIG. 6 is a rear view of the lighter; and,  
FIG. 7 is a front view of the lighter.

**1 Claim, 2 Drawing Sheets**

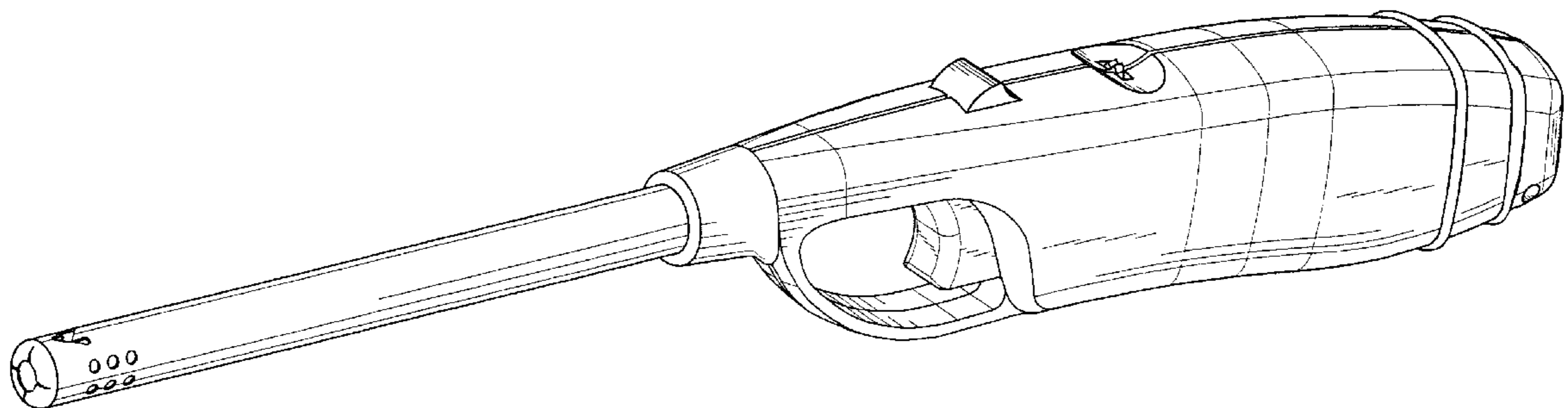

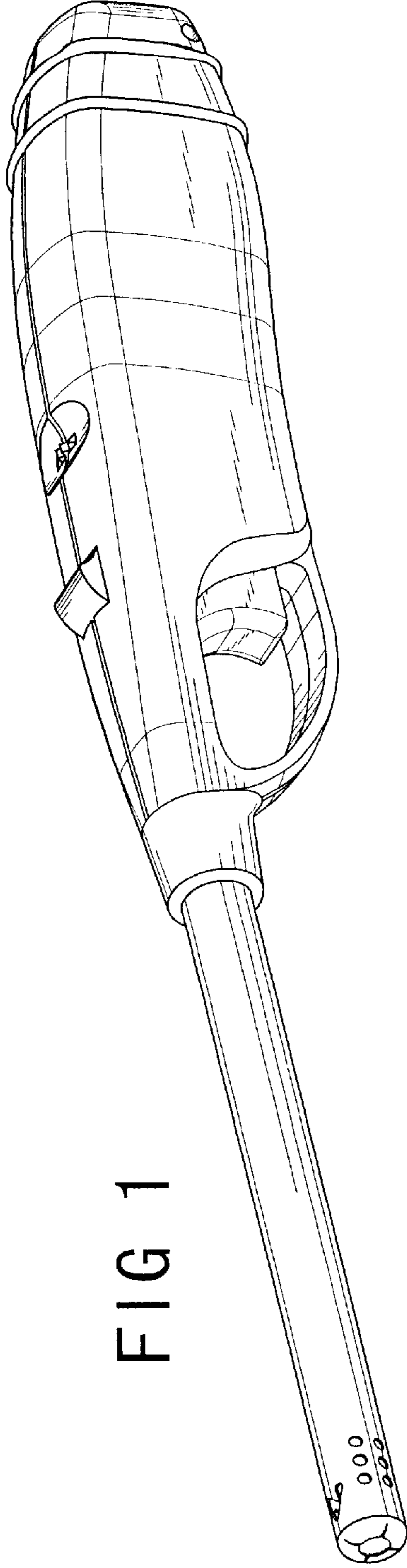

FIG 1

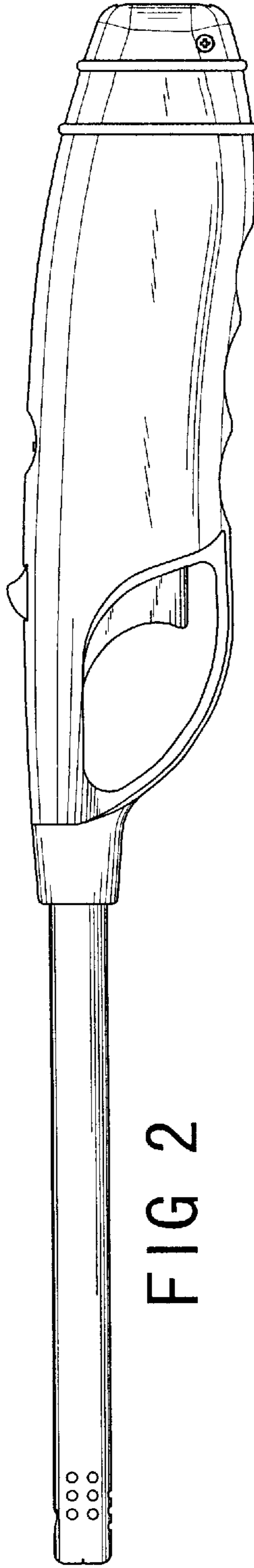

FIG 2

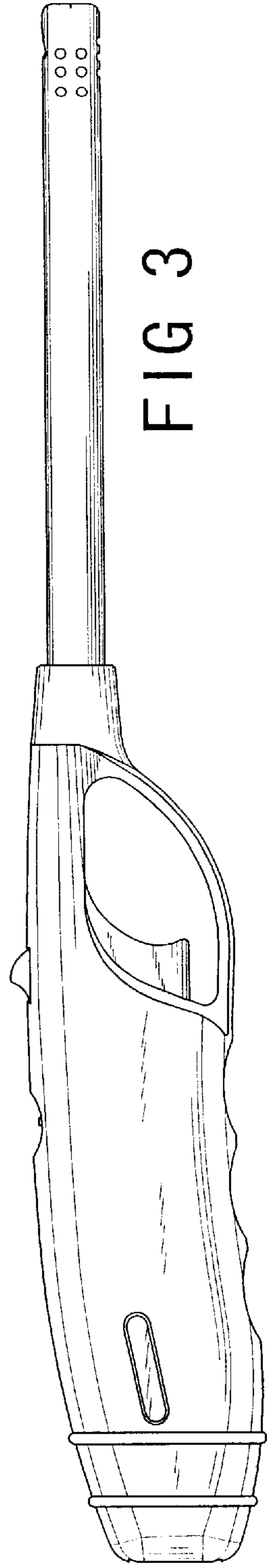

FIG 3

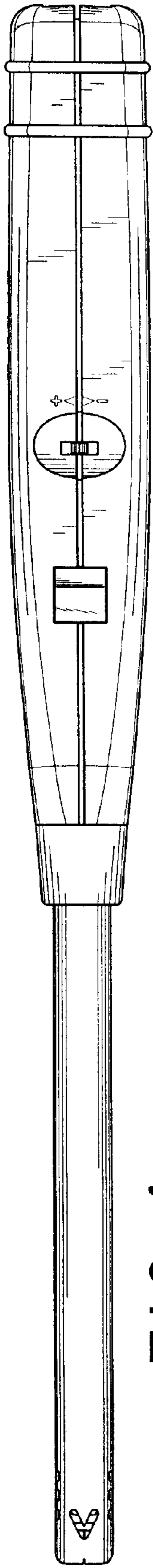

FIG 4

FIG 5

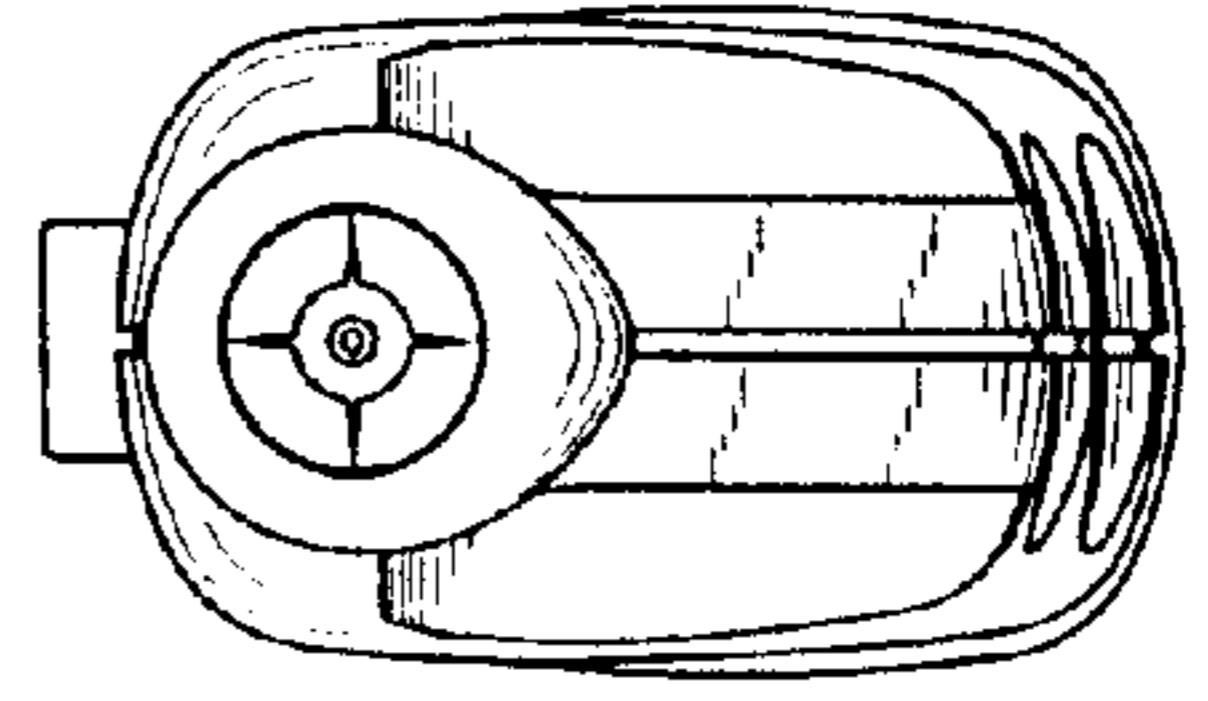
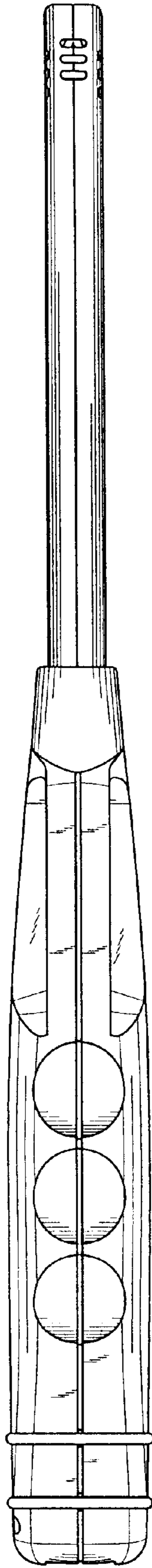

FIG 7

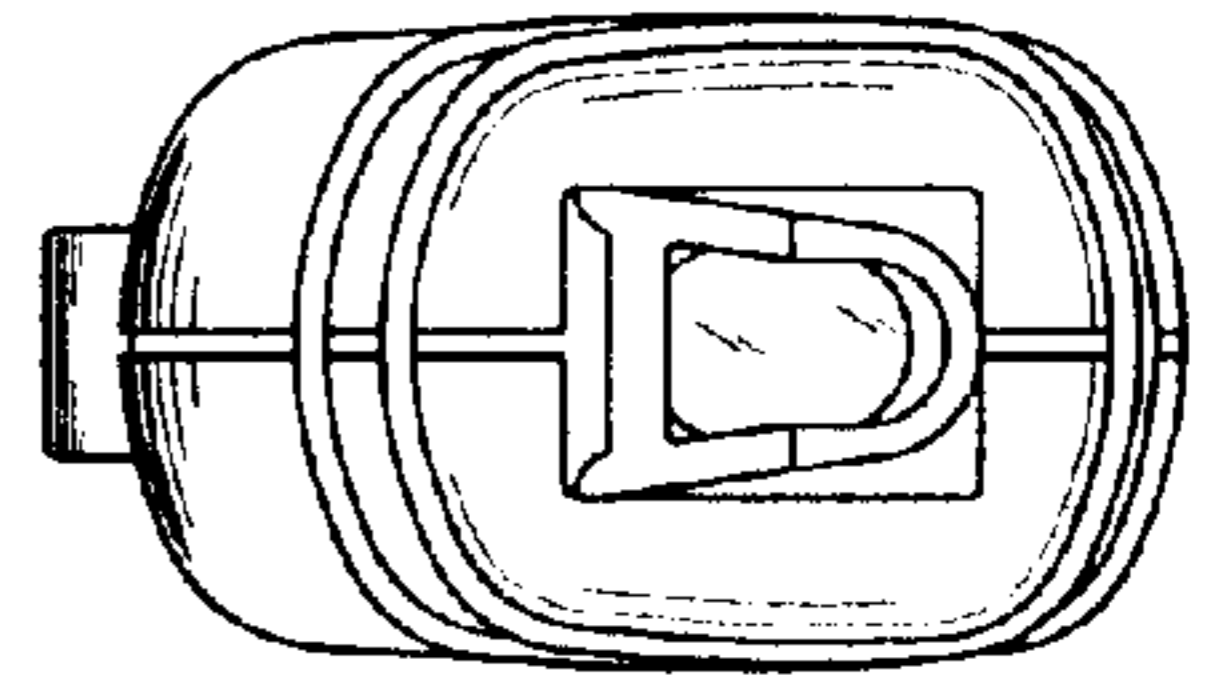

FIG 6