



US00D482929S

(12) **United States Design Patent** (10) **Patent No.:** **US D482,929 S**
Rae (45) **Date of Patent:** **** Dec. 2, 2003**

(54) **HANDLE FOR LID FOR ARTICLE OF COOKWARE**

(74) *Attorney, Agent, or Firm*—Wood, Herron & Evans, L.L.P.

(75) **Inventor:** **Bob Rae, Kowloon (HK)**

(57) **CLAIM**

(73) **Assignee:** **Meyer Intellectual Properties Limited (HK)**

The ornamental design for a “handle for lid for article of cookware”, as shown and described.

(**) **Term:** **14 Years**

DESCRIPTION

(21) **Appl. No.:** **29/176,006**

FIG. 1 is a perspective view of a “handle for lid for article of cookware” showing my new design;

(22) **Filed:** **Feb. 14, 2003**

FIG. 2 is a top view thereof;

(51) **LOC (7) Cl.** **07-02**

(52) **U.S. Cl.** **D7/394**

FIG. 3 is a bottom view thereof;

(58) **Field of Search** D7/393, 394, 354–361;
D8/306, 317; 16/430, 431, 110.1, 436,
444, DIG. 24; 220/573.1–573.5, 752–755,
758, 768, 912

FIG. 4 is a side view thereof;

FIG. 5 is another side view thereof;

FIG. 6 is a front view thereof; and,

FIG. 7 is a rear view thereof.

(56) **References Cited**
PUBLICATIONS

The part of the drawings shown in phantom lines depicts the environment of my new design and forms no part of the design.

Chef’s Catalog, 5/01, p. 3, handle on lid of pans.*

* cited by examiner

Primary Examiner—Terry A. Wallace

1 Claim, 6 Drawing Sheets

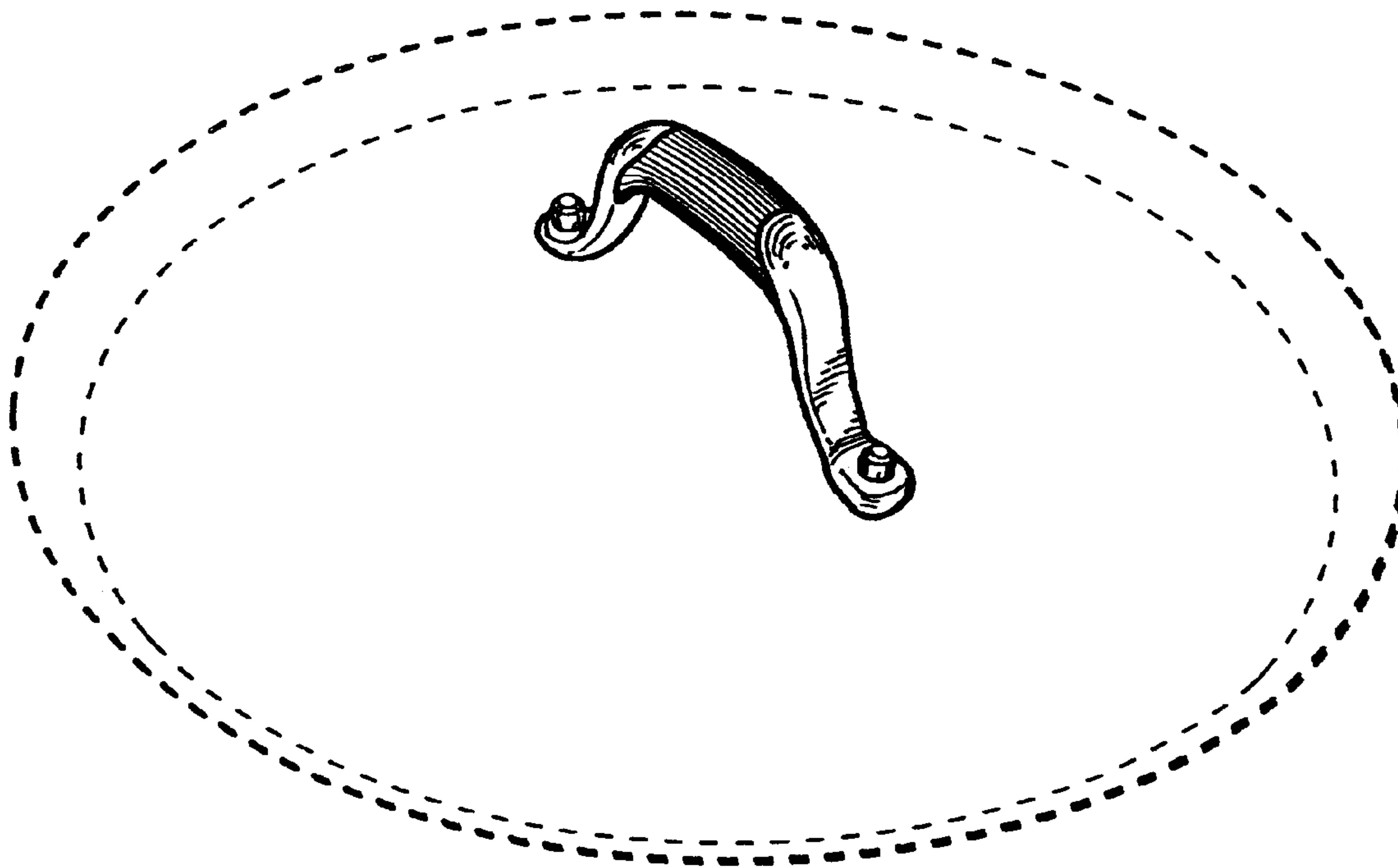

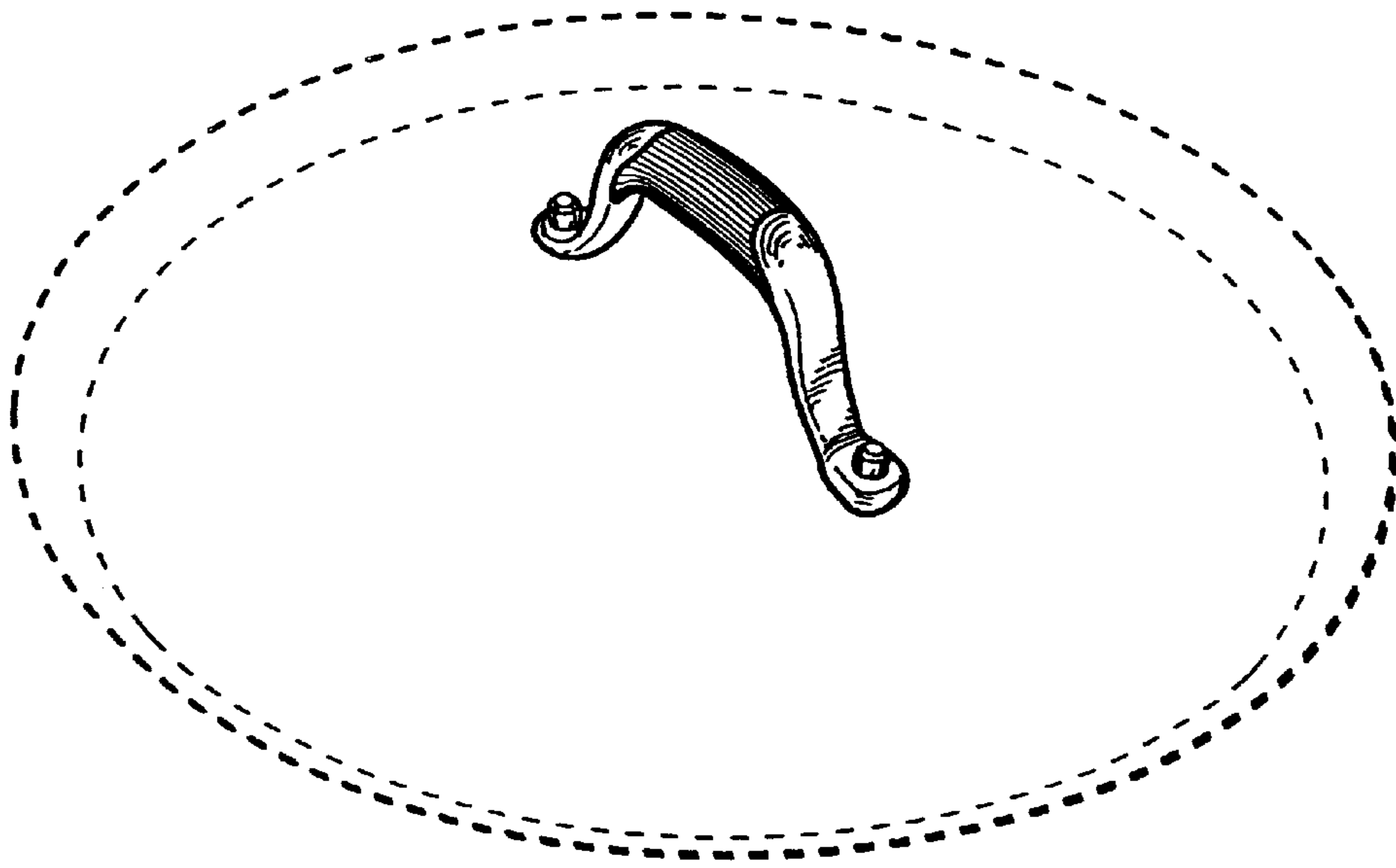

FIG. 1

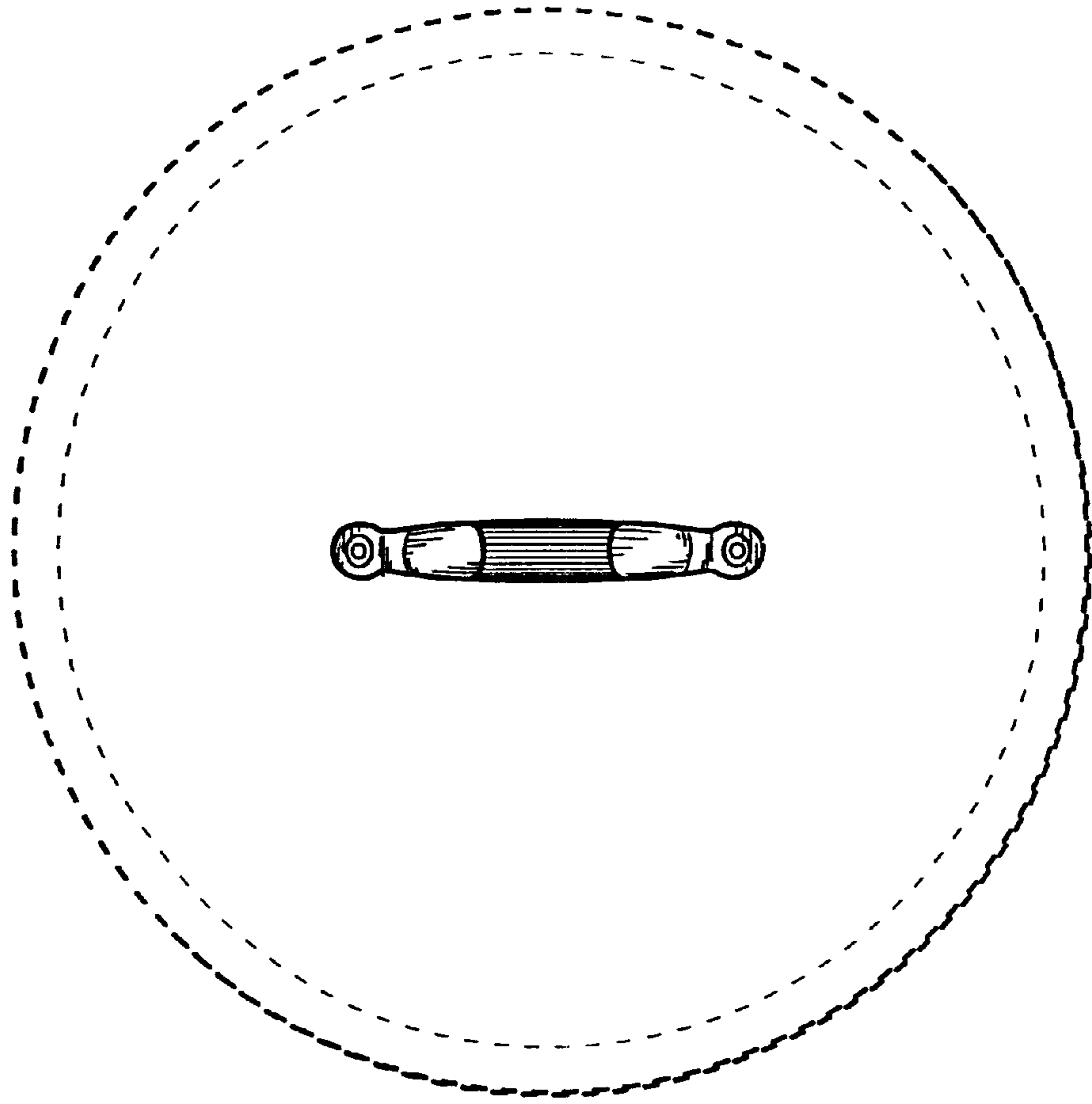

FIG. 2

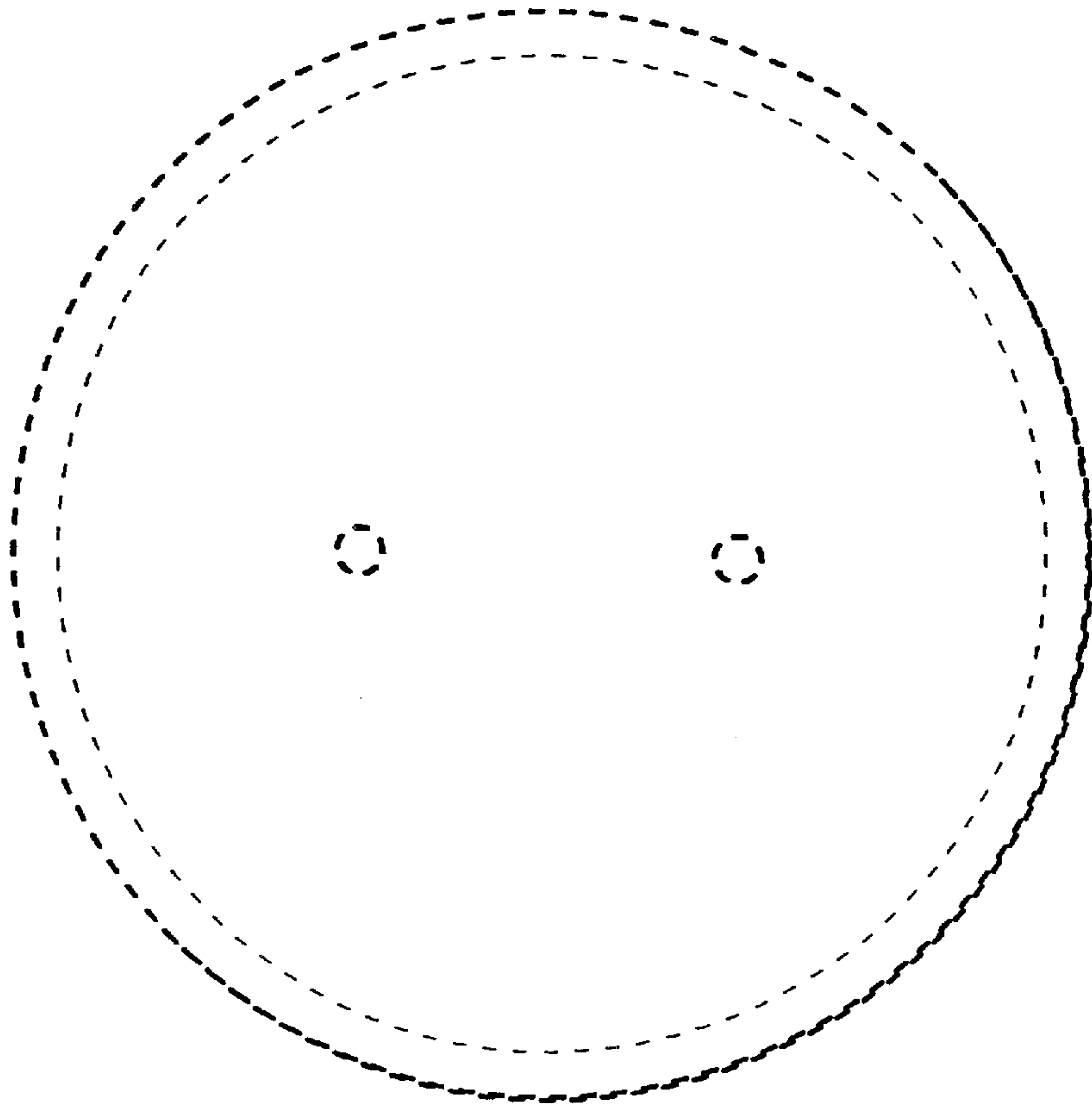

FIG. 3

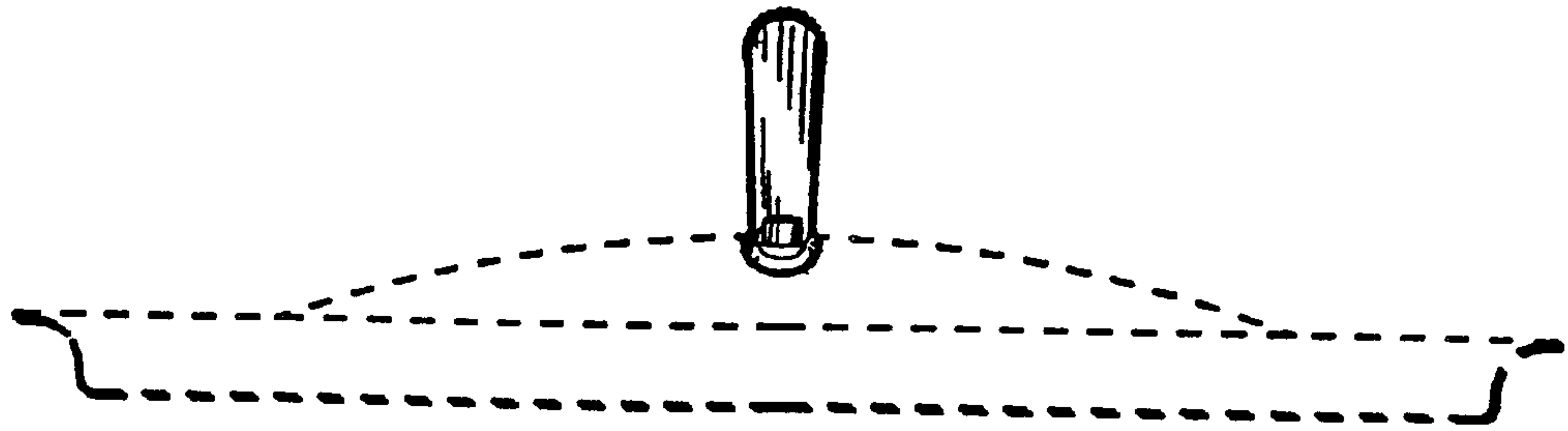

FIG. 4

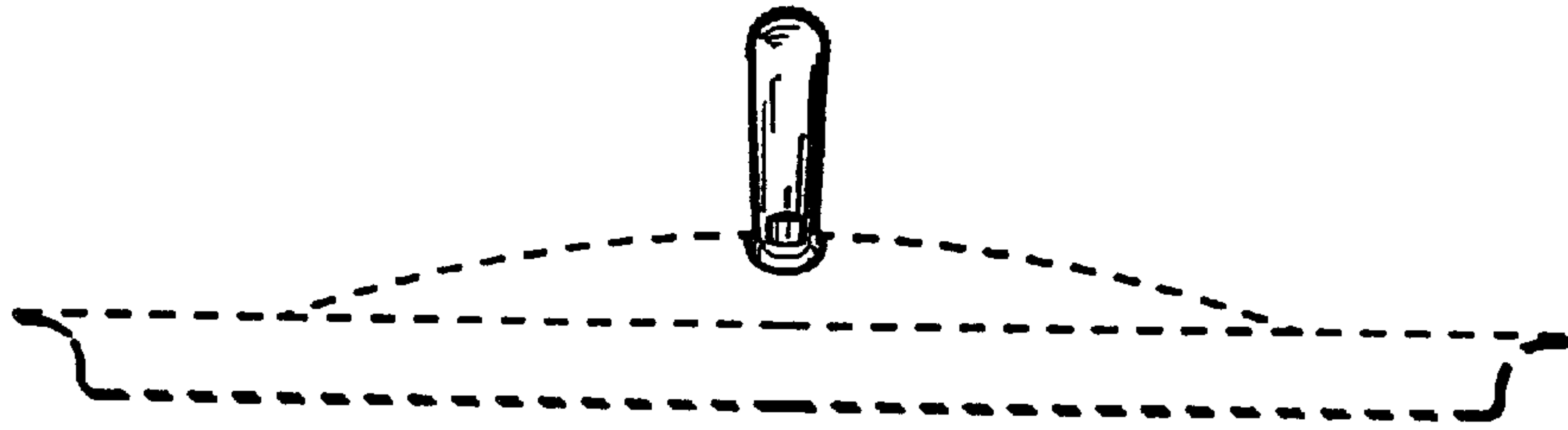

FIG. 5

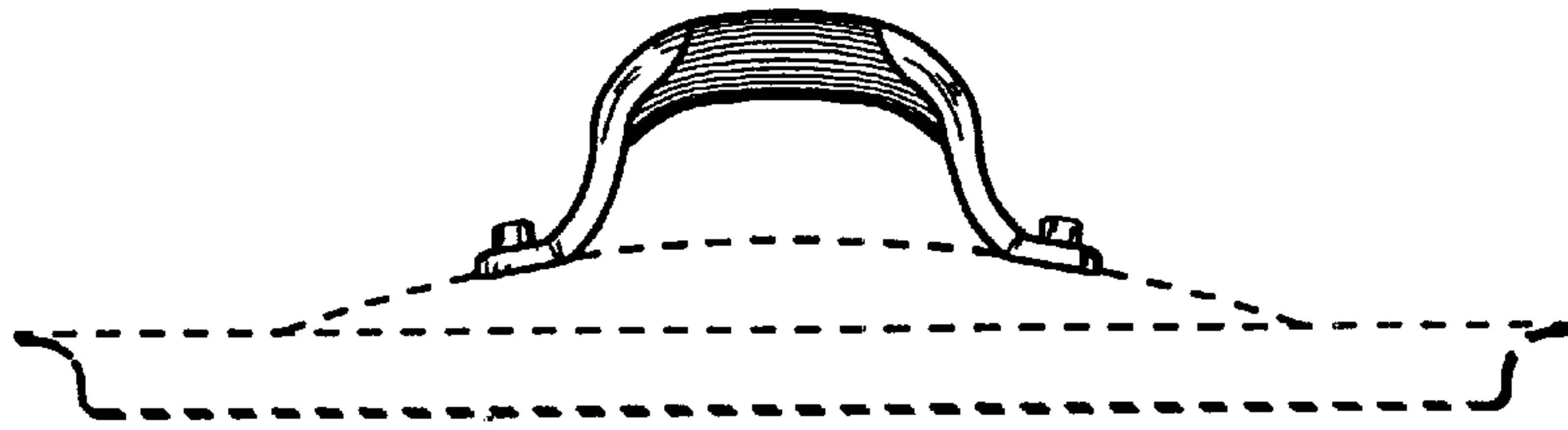

FIG. 6

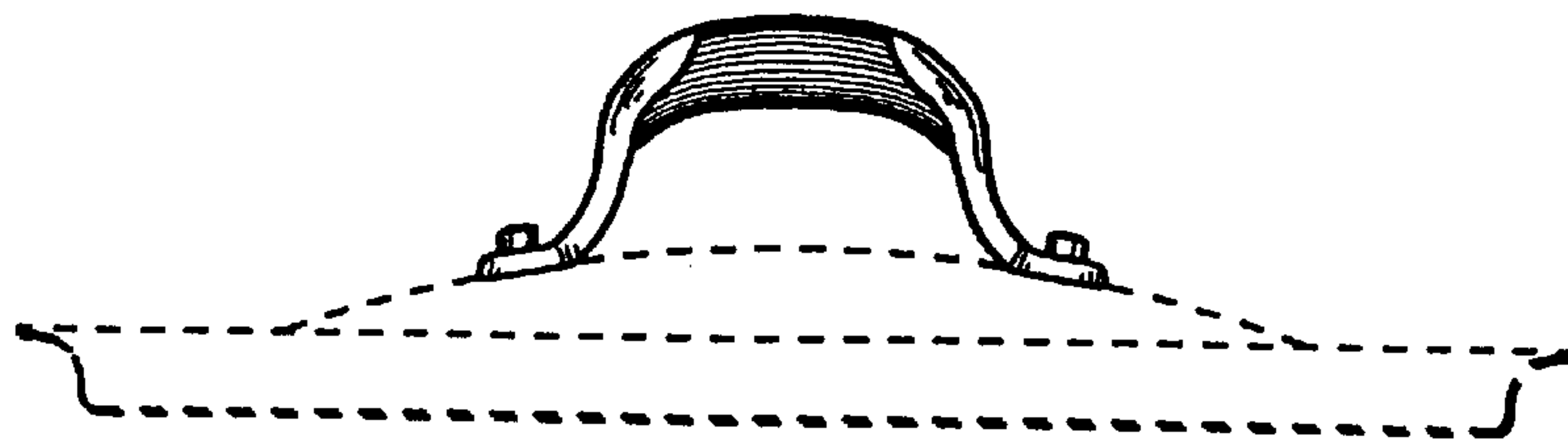

FIG. 7