



US00D482928S

(12) **United States Design Patent**
Liu

(10) **Patent No.:** **US D482,928 S**

(45) **Date of Patent:** **** Dec. 2, 2003**

(54) **COVER FOR A FOOD CONTAINER**

(75) **Inventor:** **Anita Suk Ping Liu**, Orlando, FL (US)

(73) **Assignee:** **Dart Industries Inc.**, Orlando, FL (US)

(**) **Term:** **14 Years**

(21) **Appl. No.:** **29/172,416**

(22) **Filed:** **Dec. 11, 2002**

(51) **LOC (7) Cl.** **07-07**

(52) **U.S. Cl.** **D7/392.1**

(58) **Field of Search** D7/601, 602, 629,
D7/612-615, 538-542, 391-392.1; D9/414,
425, 424, 435, 443, 454; 220/574, 574.1,
780-806, 669-676, 309.1, 367.1, 376, 377

(56) **References Cited**

U.S. PATENT DOCUMENTS

D263,283 S	3/1982	Ronayne	
D312,777 S	12/1990	Courreges	
D343,338 S	1/1994	Bucher et al.	
D343,340 S	1/1994	Frye, Jr. et al.	
D370,152 S	5/1996	Kostelni	
D382,769 S	* 8/1997	Jeppesen et al. D7/392.1
D383,939 S	* 9/1997	Jeppesen et al. D7/392.1

D409,911 S	* 5/1999	Guillin D9/430
D415,385 S	* 10/1999	Loew et al. D7/392.1
D423,370 S	4/2000	Lewin D9/572
D439,774 S	4/2001	Lee D6/501
D443,471 S	6/2001	Lillelund et al. D7/398
D445,650 S	7/2001	Maxwell et al. D7/629
D448,969 S	10/2001	Conti D7/392.1

* cited by examiner

Primary Examiner—Terry A. Wallace

(74) *Attorney, Agent, or Firm*—John A. Doninger

(57) **CLAIM**

The ornamental design for a cover for a food container, as shown and described.

DESCRIPTION

FIG. 1 is a top, side and front perspective view of a cover for a food container showing the new design; FIG. 2 is a front elevation view thereof; FIG. 3 is a rear elevation view thereof; FIG. 4 is a right side elevation view thereof; FIG. 5 is a left side elevation view thereof; FIG. 6 is a top plan view thereof; and, FIG. 7 is a bottom plan view thereof.

1 Claim, 3 Drawing Sheets

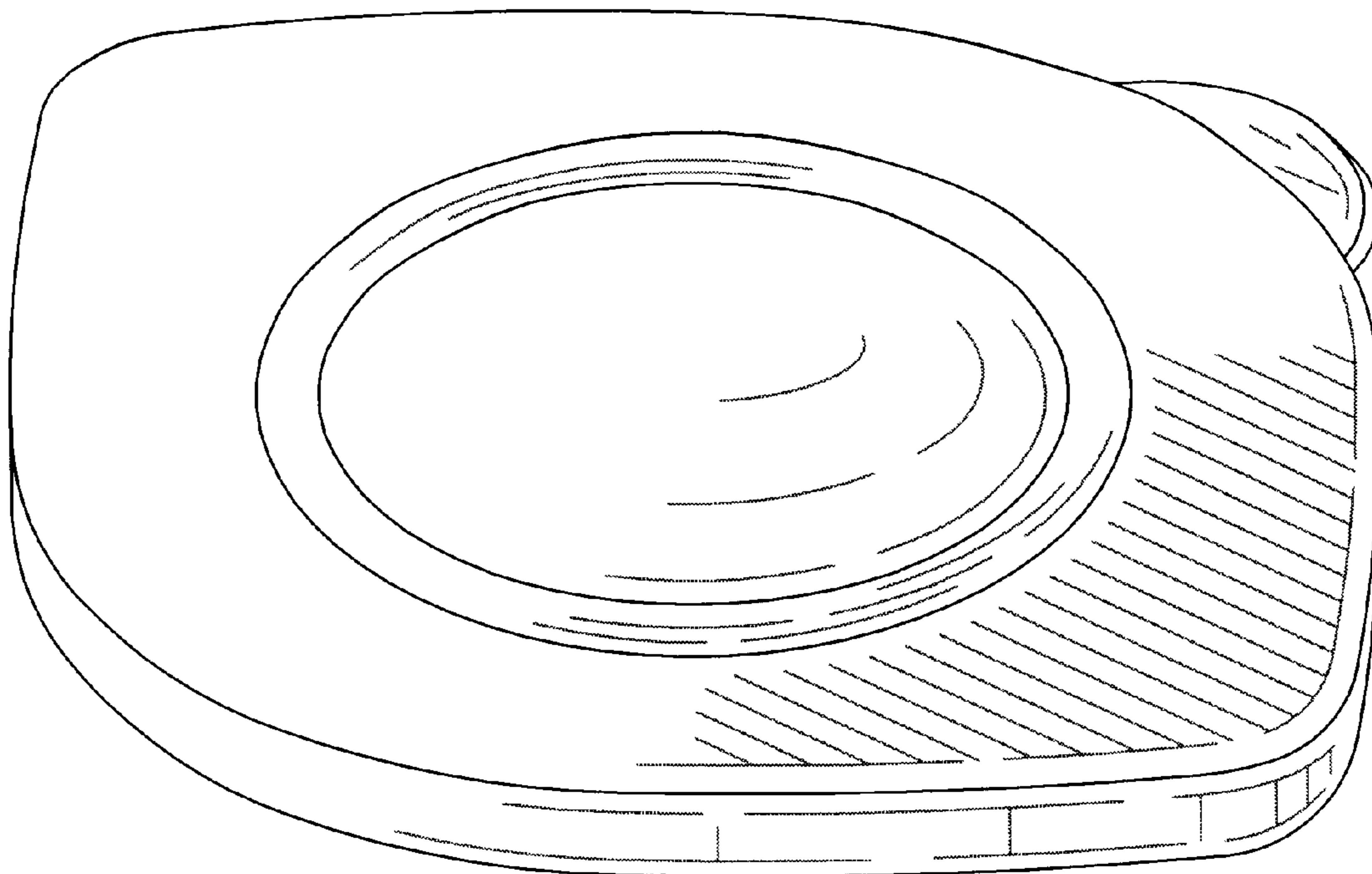

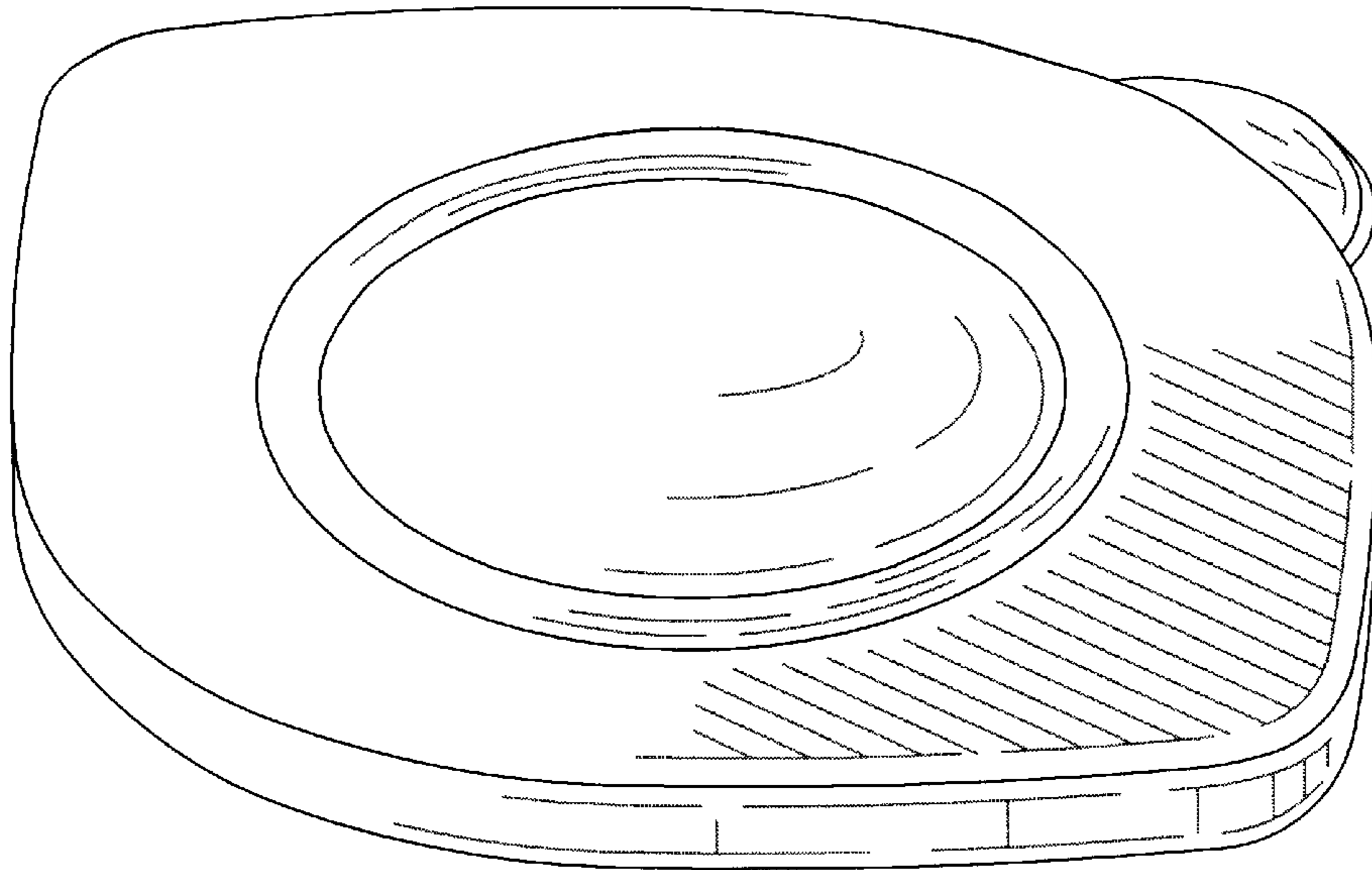

FIG. 1

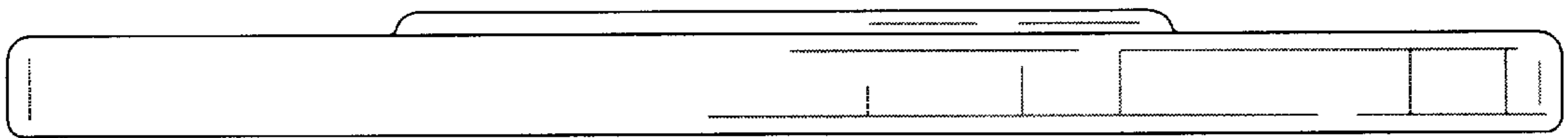

FIG. 2

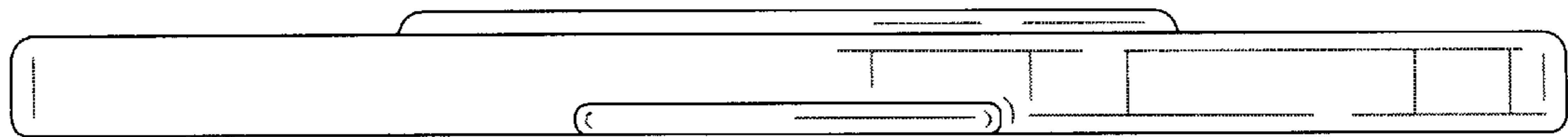

FIG. 3

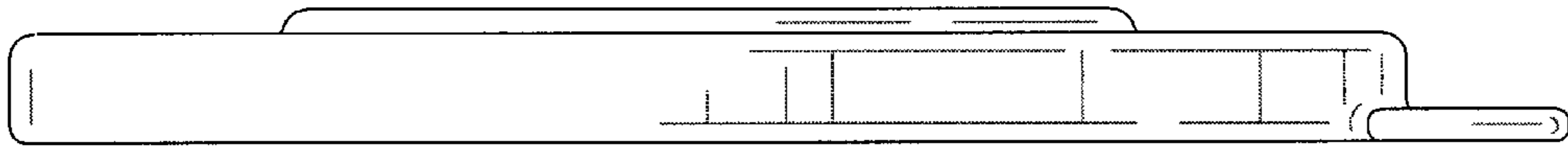

FIG. 4

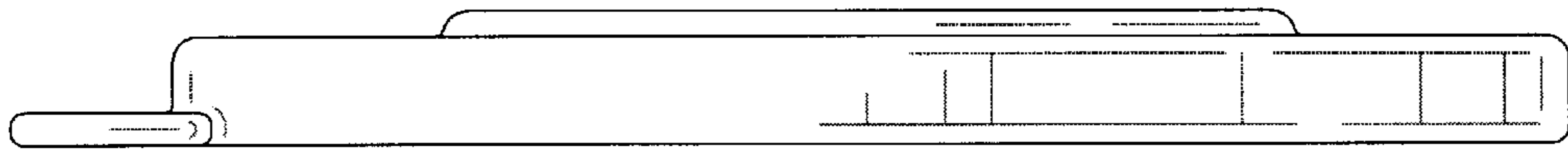

FIG. 5

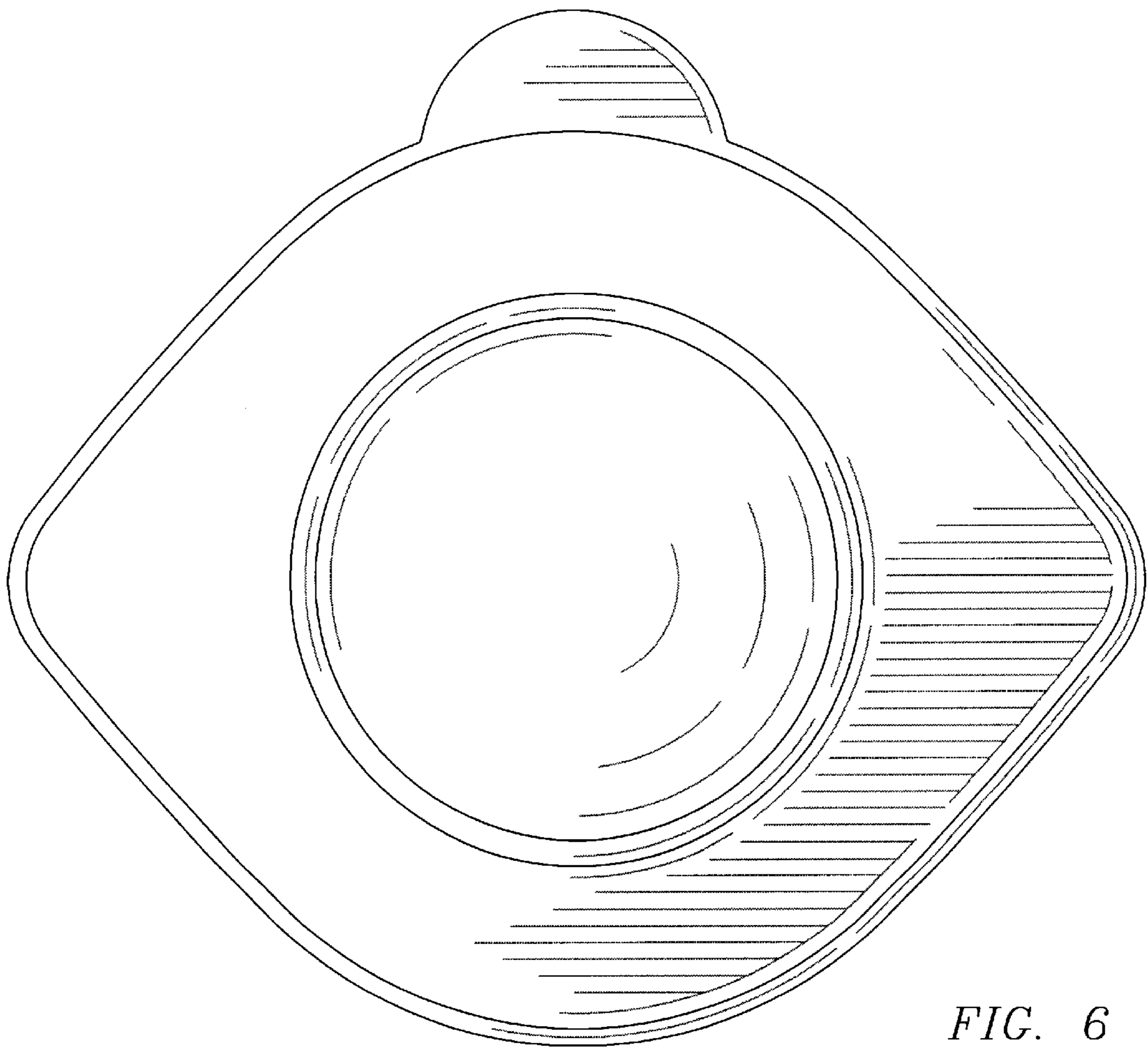

FIG. 6

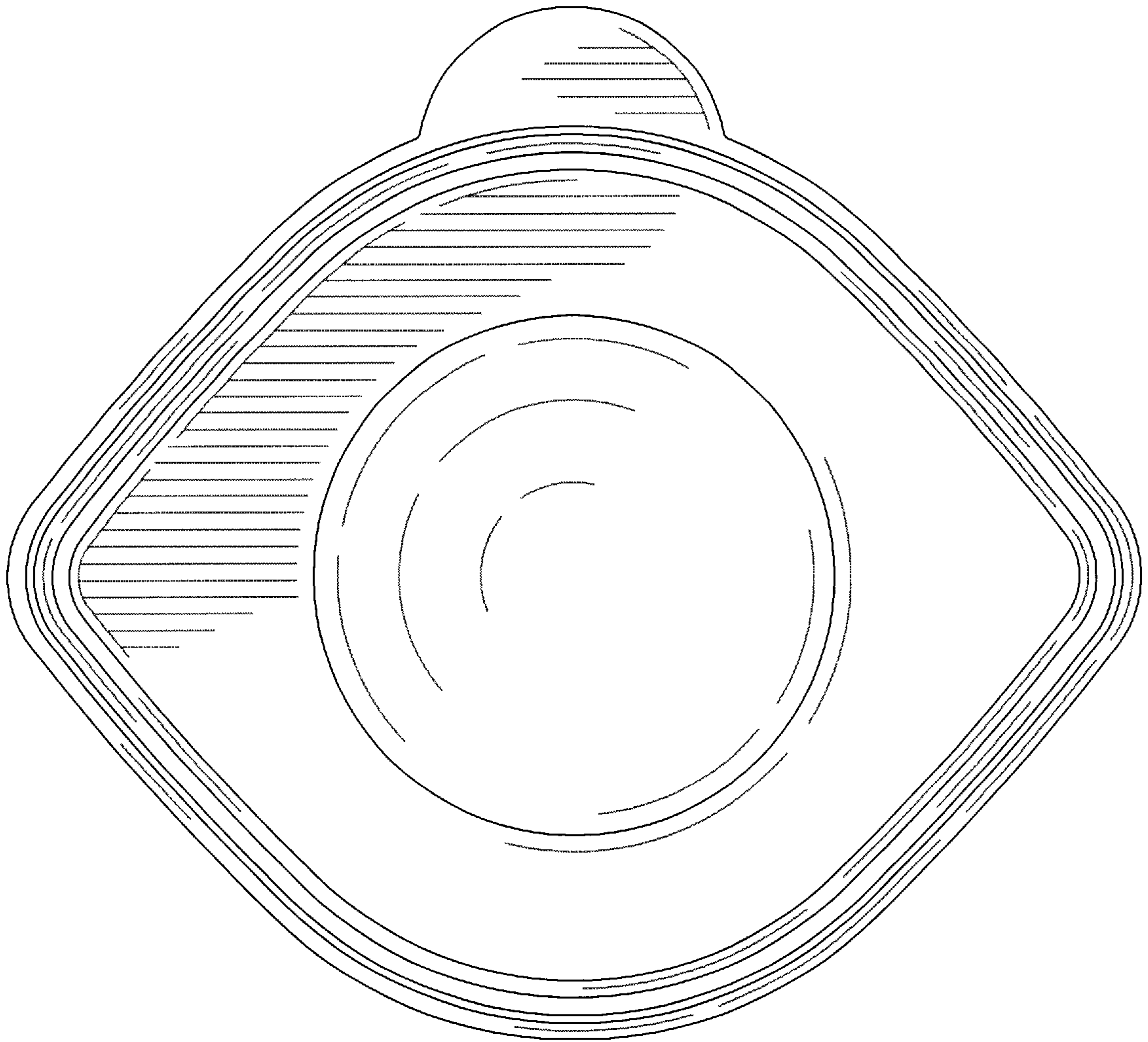

FIG. 7