



US00D482904S

(12) **United States Design Patent**
Slymaker

(10) **Patent No.:** **US D482,904 S**

(45) **Date of Patent:** **** Dec. 2, 2003**

(54) **FOLDABLE MUSICAL INSTRUMENT STAND**

(76) **Inventor:** **Duane Alan Slymaker**, 2626 Shiprock Rd., Willow Street, PA (US) 17584

(**) **Term:** **14 Years**

(21) **Appl. No.:** **29/172,042**

(22) **Filed:** **Dec. 4, 2002**

(51) **LOC (7) Cl.** **06-06**

(52) **U.S. Cl.** **D6/466; D6/310; D6/419**

(58) **Field of Search** **D6/300-303, 308-314, D6/419, 466; 40/400, 711; 248/441.1, 445, 450, 460, 463, 465, 465.1; D17/99; 84/327**

(56) **References Cited**

U.S. PATENT DOCUMENTS

3,057,591 A	*	10/1962	Weimer	248/460
D227,326 S	*	6/1973	Venuta	D6/310
D394,160 S	*	5/1998	Yarbrough	D6/310
5,973,244 A	*	10/1999	McCulloch	84/327
D436,465 S	*	1/2001	Berkman	D6/466

* cited by examiner

Primary Examiner—Janice E. Seeger

(57) **CLAIM**

The ornamental design for a foldable musical instrument stand, as shown and described.

DESCRIPTION

FIG. 1 is a front perspective open view of the foldable musical instrument stand of my invention, which is suitable for holding a guitar (not shown) at rest;

FIG. 2 is a front elevational, open view of the foldable musical instrument stand of my invention;

FIG. 3 is a rear elevational, open view of the foldable musical instrument stand of my invention, which is a reverse view of FIG. 2;

FIG. 4 is a side open view of the foldable musical instrument stand of my invention, which is based on FIG. 3, rotated ninety degrees leftwardly about a vertical axis;

FIG. 5 is a side, open view of the foldable musical instrument stand of my invention, which is a reverse view of FIG. 4;

FIG. 6 is a top plan, open view of the foldable musical instrument stand of my invention;

FIG. 7 is a bottom plan, open view of the foldable musical instrument stand of my invention, which is a reverse view of FIG. 6;

FIG. 8 is a front elevational, closed view of the foldable musical instrument stand of my invention; and,

FIG. 9 is a rear elevational, closed view of the foldable musical instrument stand of my invention, which is a reverse view of FIG. 8.

1 Claim, 9 Drawing Sheets

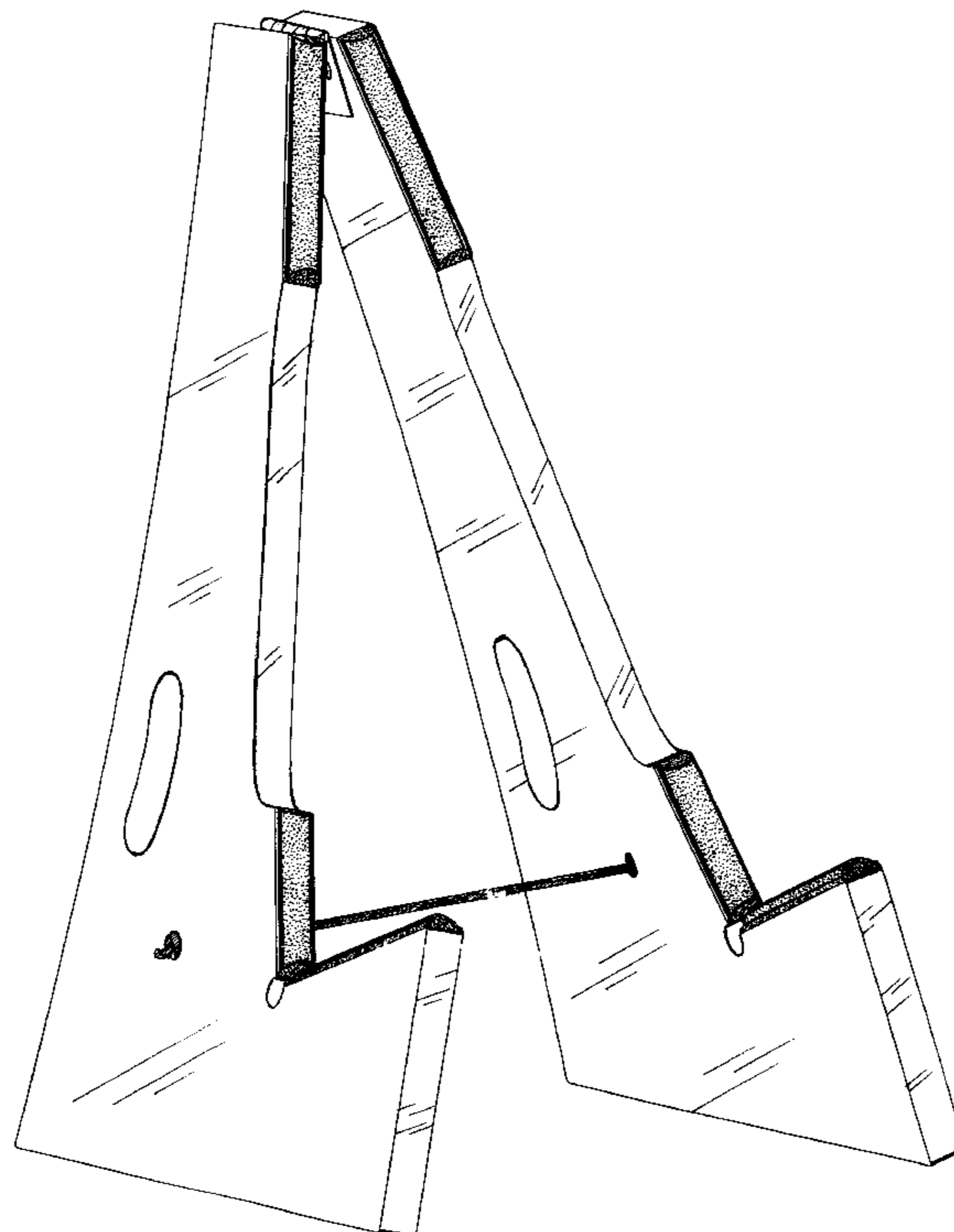

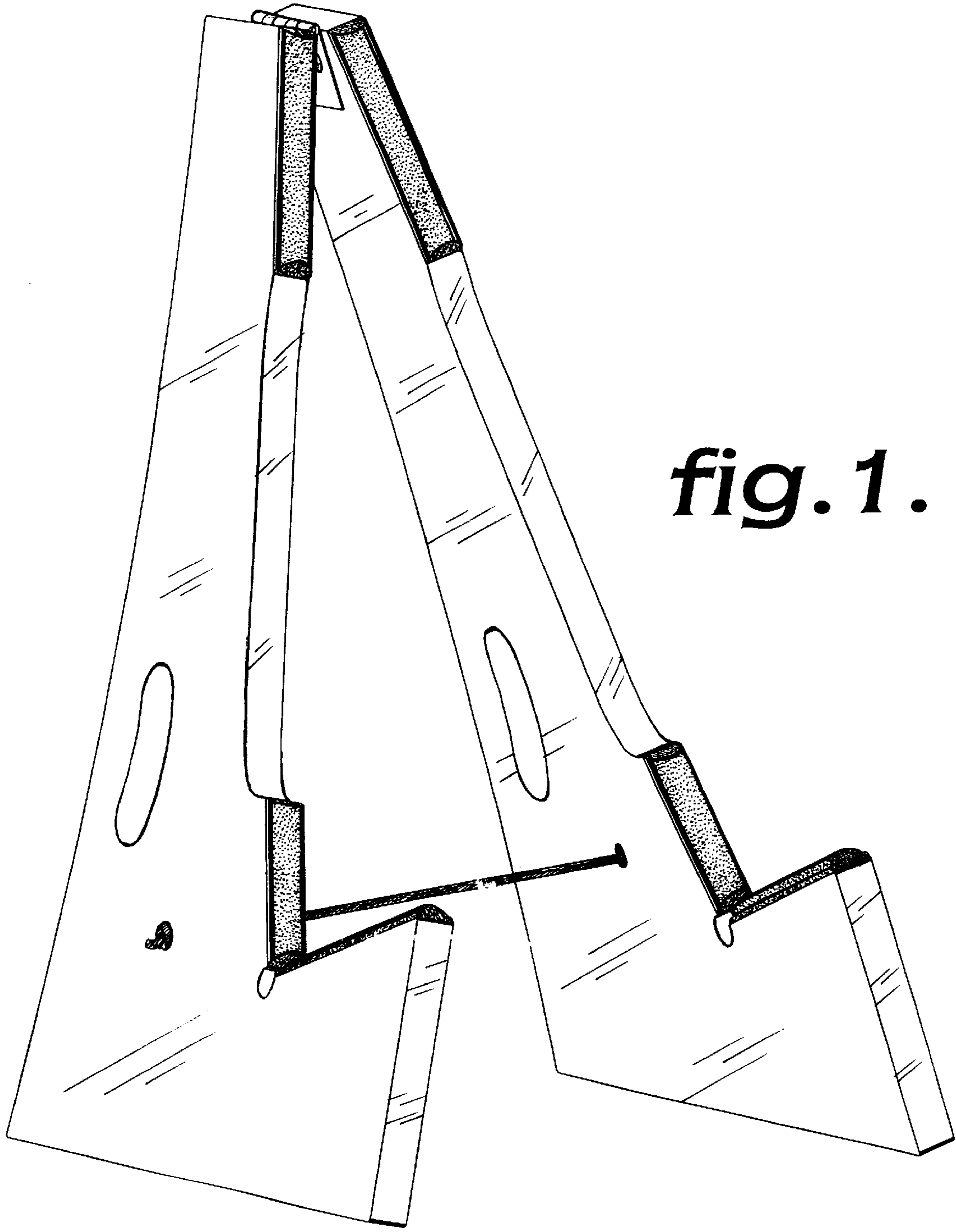

fig. 1.

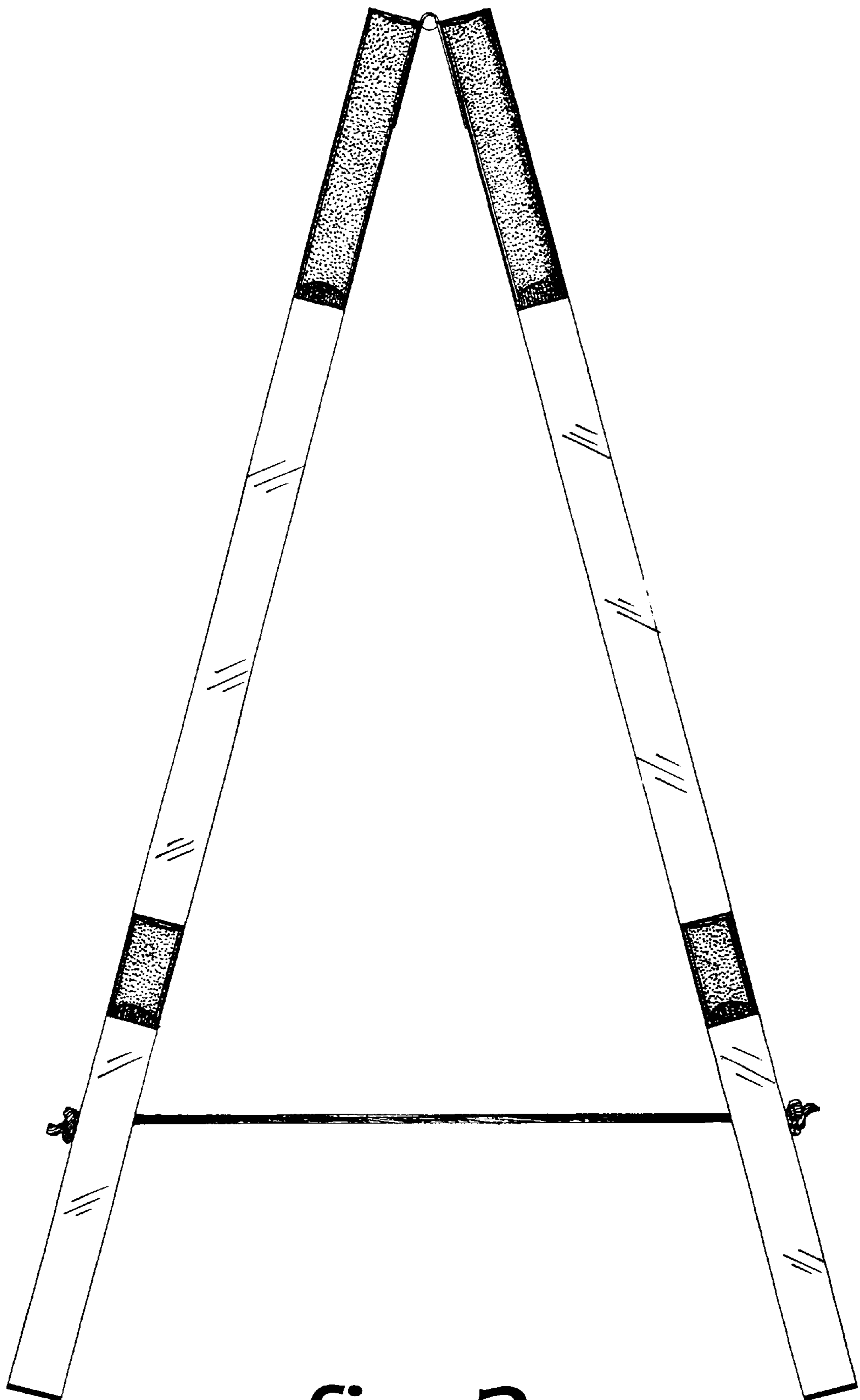

fig.2.

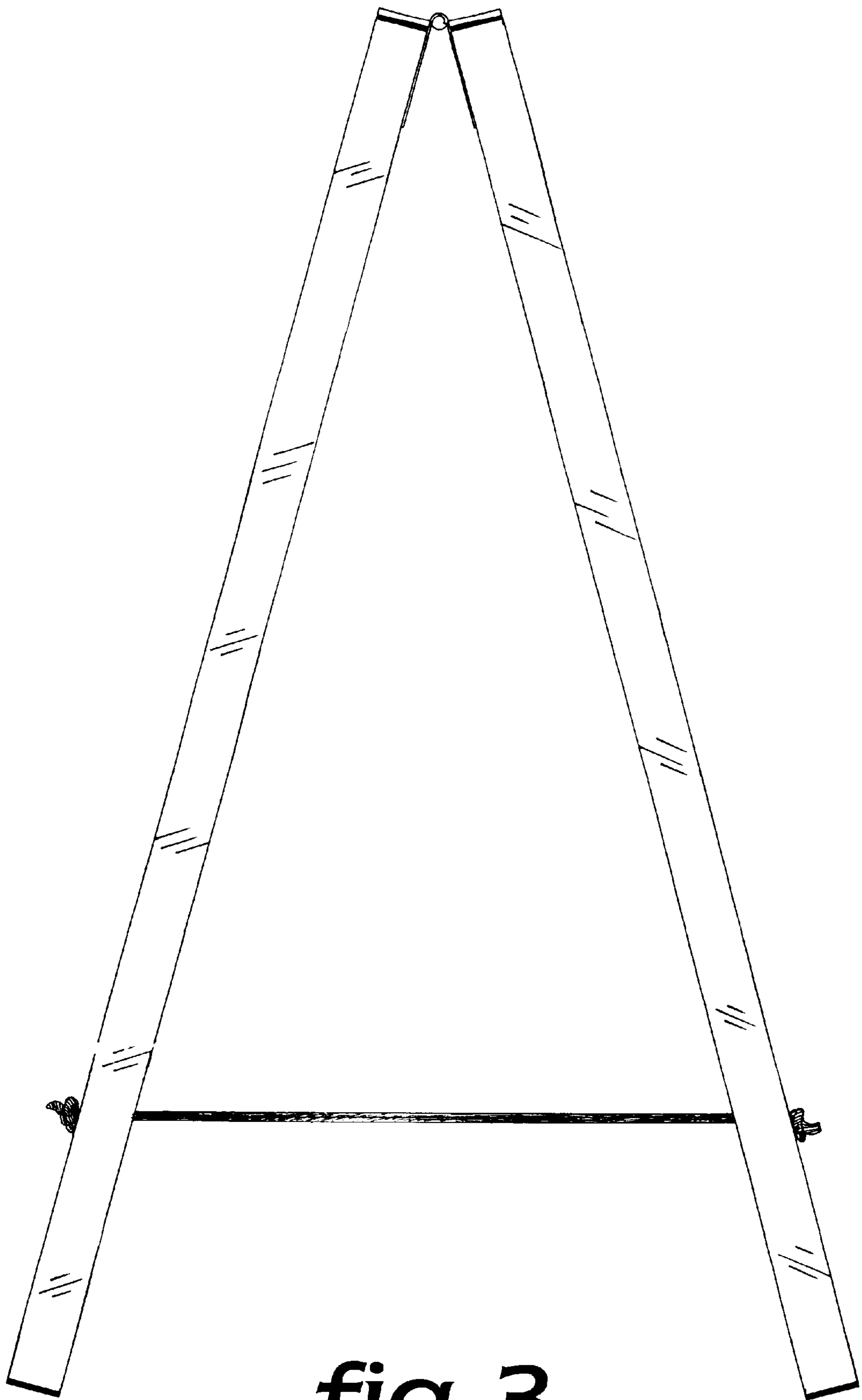

fig.3.

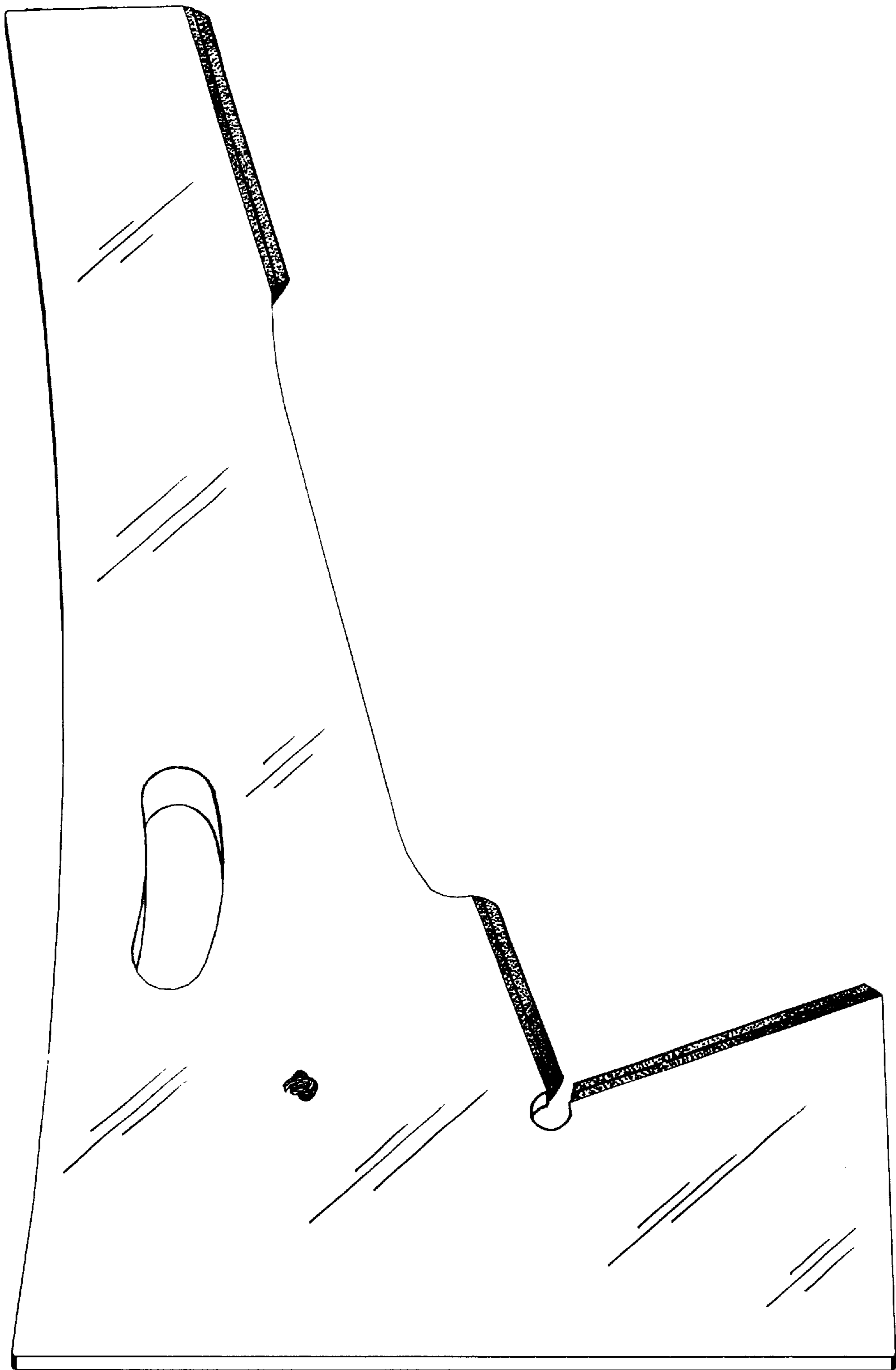

fig. 4.

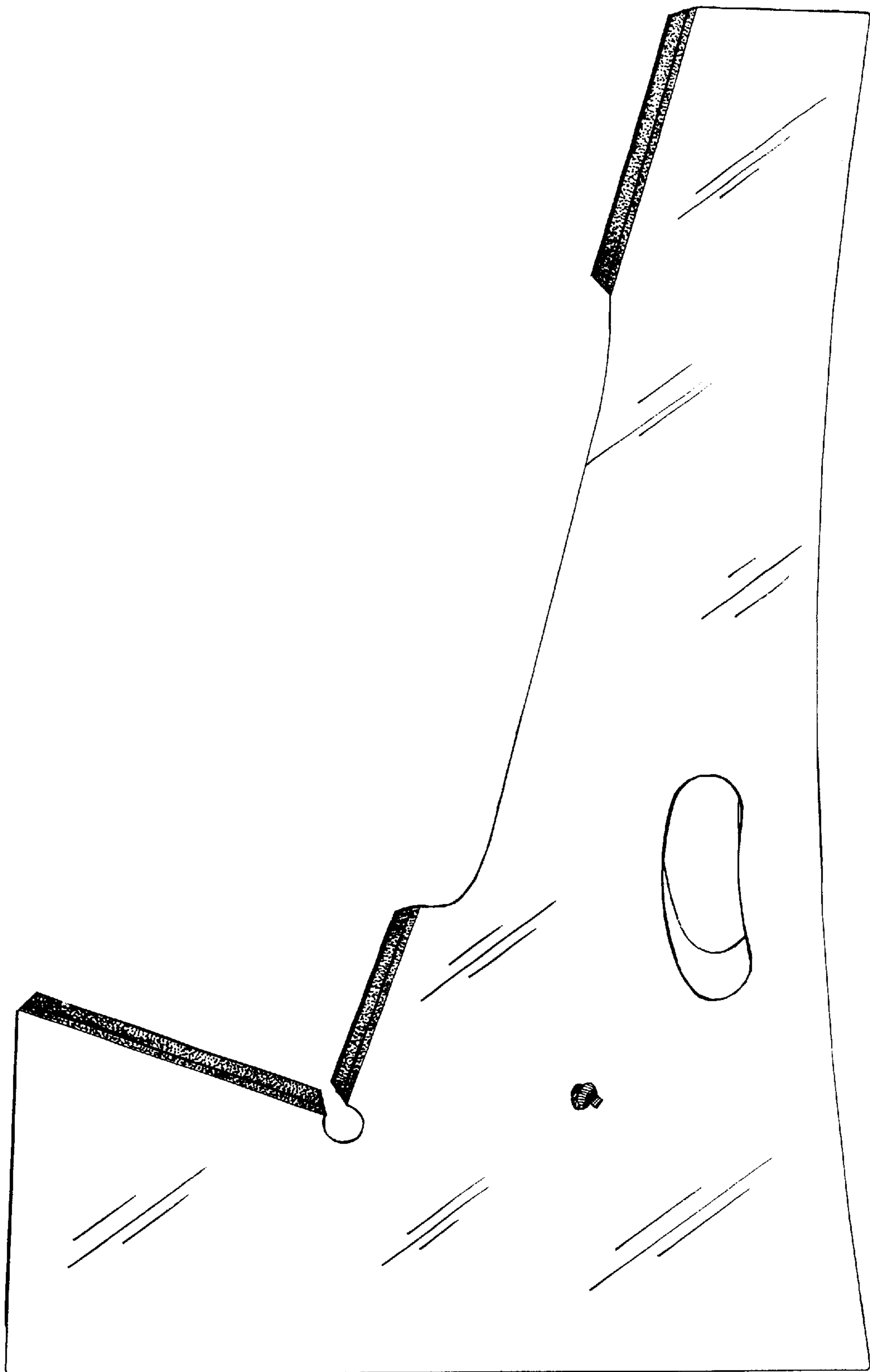

fig.5.

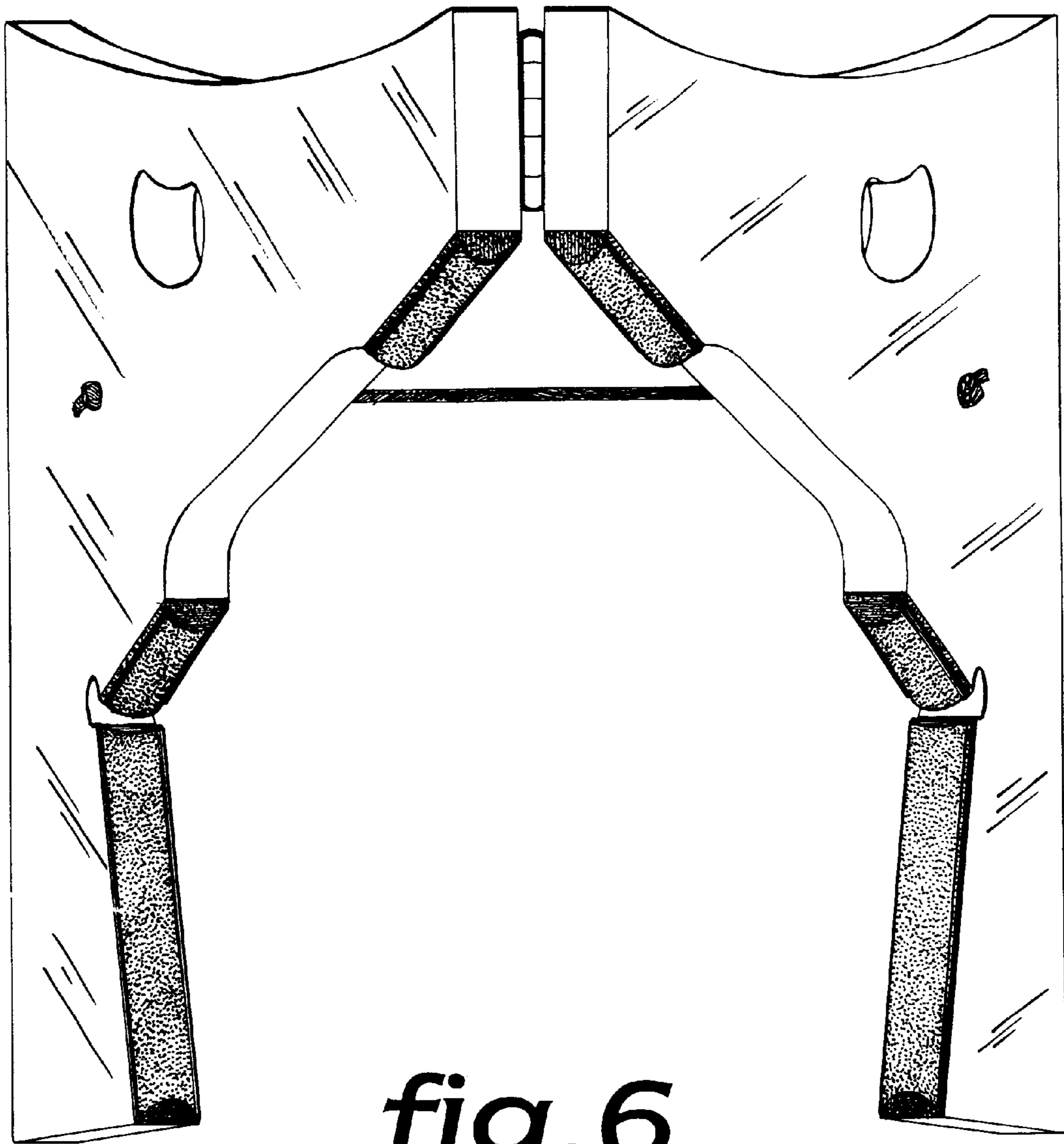

fig. 6.

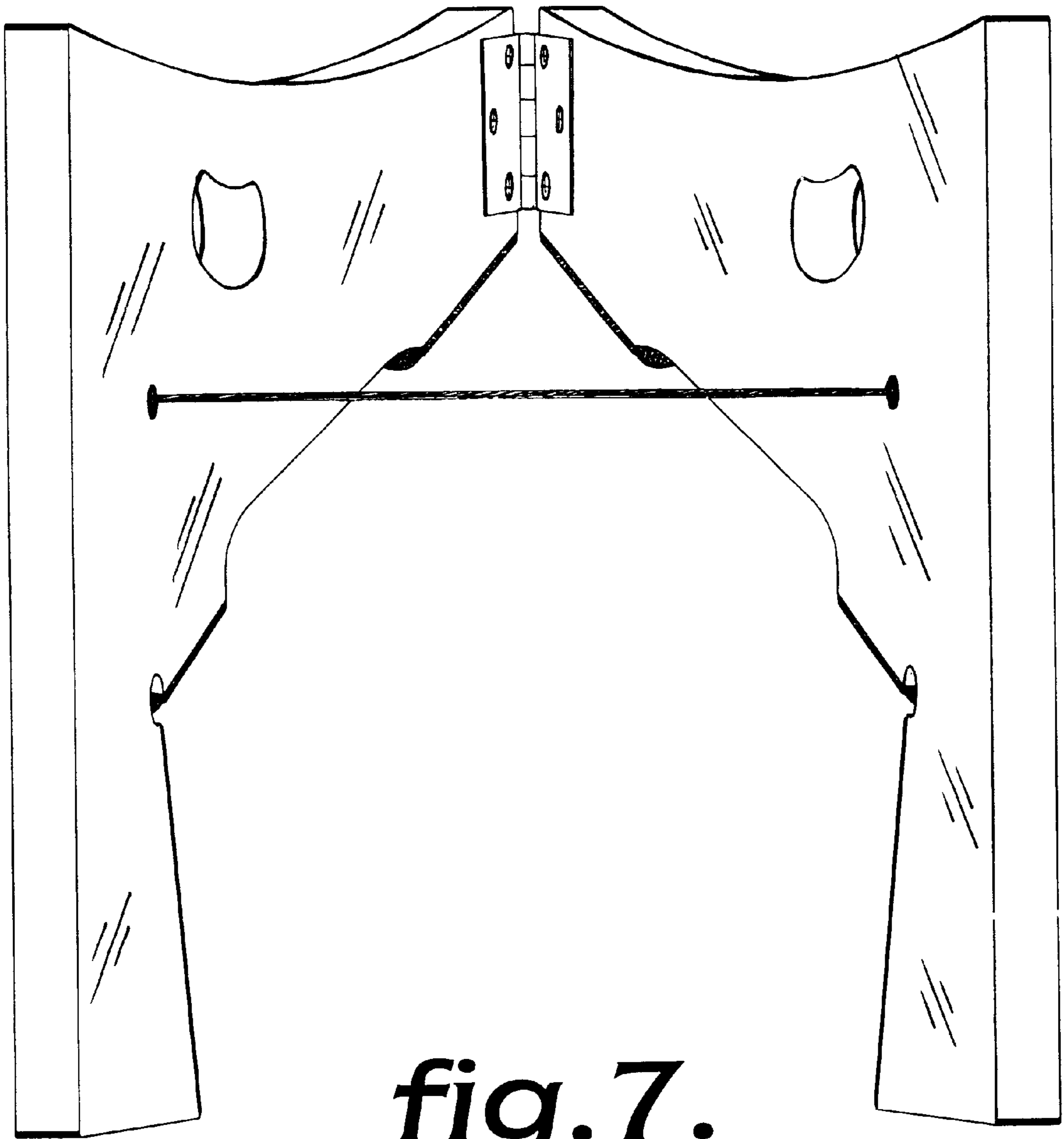

fig. 7.

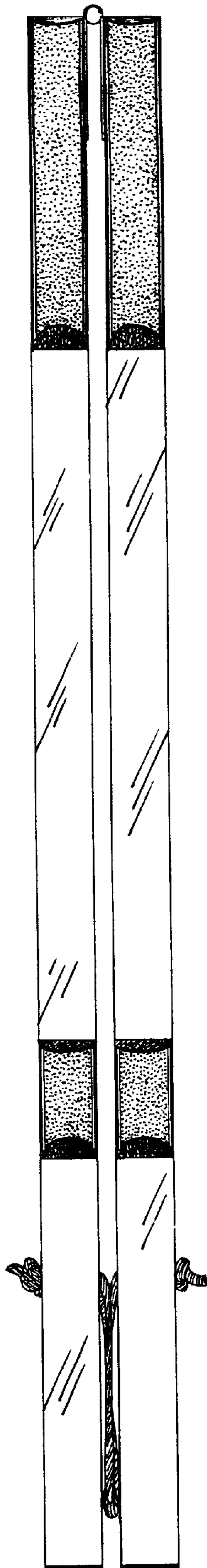

fig. 8.

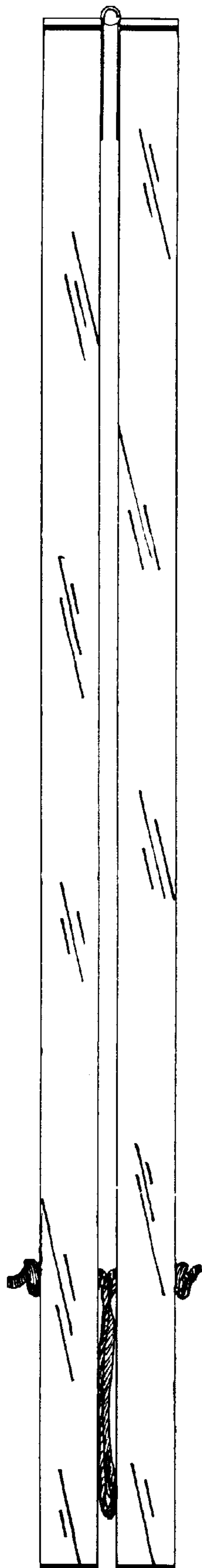

fig. 9.