



US00D482864S

(12) **United States Design Patent**  
**Hillman**

(10) **Patent No.:** **US D482,864 S**

(45) **Date of Patent:** **\*\* Dec. 2, 2003**

(54) **CAMERA STORAGE CASE**

(75) Inventor: **Jack L. Hillman**, Colorado Springs,  
CO (US)

(73) Assignee: **Case Logic, Inc.**, Longmont, CO (US)

(\*\*) Term: **14 Years**

(21) Appl. No.: **29/166,476**

(22) Filed: **Aug. 27, 2002**

(51) **LOC (7) Cl.** ..... **03-01**

(52) **U.S. Cl.** ..... **D3/267; D3/263**

(58) **Field of Search** ..... D3/208, 215, 219,  
D3/225, 226, 243, 263, 267, 268, 270,  
273, 276, 283, 285, 287, 289, 290, 301;  
D6/632; D21/618, 654; 206/316.1, 316.2;  
224/583, 612, 908

(56) **References Cited**

**U.S. PATENT DOCUMENTS**

D418,287 S	*	1/2000	Moor	.....	D3/201
D428,700 S		8/2000	Hillman	.....	D3/287
D434,897 S		12/2000	Hillman	.....	D3/218
D436,443 S		1/2001	Hillman	.....	D3/283
D447,631 S		9/2001	Hillman	.....	D3/289
D455,256 S	*	4/2002	Tyler	.....	D3/219
D457,723 S	*	5/2002	Tyler	.....	D3/267
D460,255 S		7/2002	Hillman	.....	D3/218
D472,372 S	*	4/2003	Hassett	.....	D3/218
D472,381 S	*	4/2003	Murdoch et al.	.....	D3/268
D472,706 S	*	4/2003	Hassett	.....	D3/289

**OTHER PUBLICATIONS**

U.S. patent application Ser. No. 29/157,487, Hassett, filed Mar. 19, 2002.

U.S. patent application Ser. No. 29/159,348, Hassett, filed Apr. 7, 2002.

U.S. patent application Ser. No. 29/162,068, Hassett, filed Jun. 7, 2002.

U.S. patent application Ser. No. 29/159,350, Hassett, filed Apr. 17, 2002.

U.S. patent application Ser. No. 29/163,597, Hassett, filed Jul. 8, 2002.

Case Logic 2002 Product Catalog, "What's Inside Survives", pp. 3, 9, 10.

Case Logic Spring 2000 Product Catalog, pp. 5, 7, 10, 11, 12.

Case Logic 2001 Essential Equipment Product Catalog, pp. 5, 6, 10, 11.

Case Logic 2000 Essential Equipment Product Catalog, pp. 5, 8, 9, 10, 11.

Case Logic 1999 Product Catalog, pp. 7, 9, 10, 11, 12.

1999 CdProjects Catalog, pp. 7, 9, 13, 24.

1998 BMI Case It Catalog, pp. 1, 2.

1997 Case Logic Audio Catalog, pp. 2, 5, 6.

(List continued on next page.)

*Primary Examiner*—Celia Murphy

(74) *Attorney, Agent, or Firm*—Sheridan Ross P.C.

(57) **CLAIM**

The ornamental design for a camera storage case, as shown and described.

**DESCRIPTION**

FIG. 1 is a front perspective view of a camera storage case showing my new design, the broken lines depicting environment and forming no part of the claimed design;

FIG. 2 is a front elevation view of the invention illustrated in FIG. 1;

FIG. 3 is a rear elevation view of the invention illustrated in FIG. 1;

FIG. 4 is a right elevation view of the invention illustrated in FIG. 1;

FIG. 5 is a left elevation view of the invention illustrated in FIG. 1;

FIG. 6 is a top plan view of the invention illustrated in FIG. 1;

FIG. 7 is a bottom plan view of the invention illustrated in FIG. 1; and,

FIG. 8 is a front perspective view of the invention illustrated in FIG. 1.

**1 Claim, 5 Drawing Sheets**

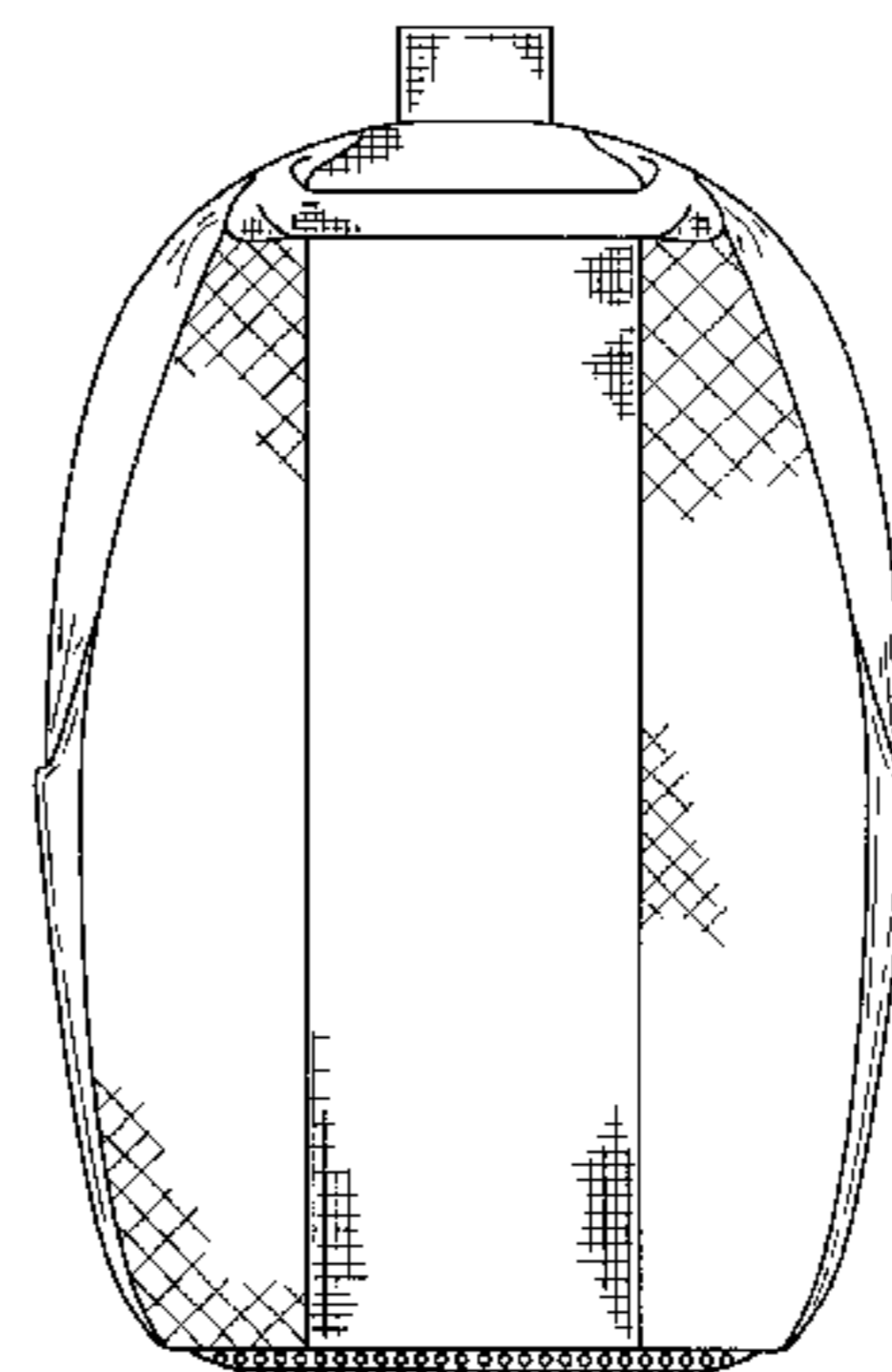
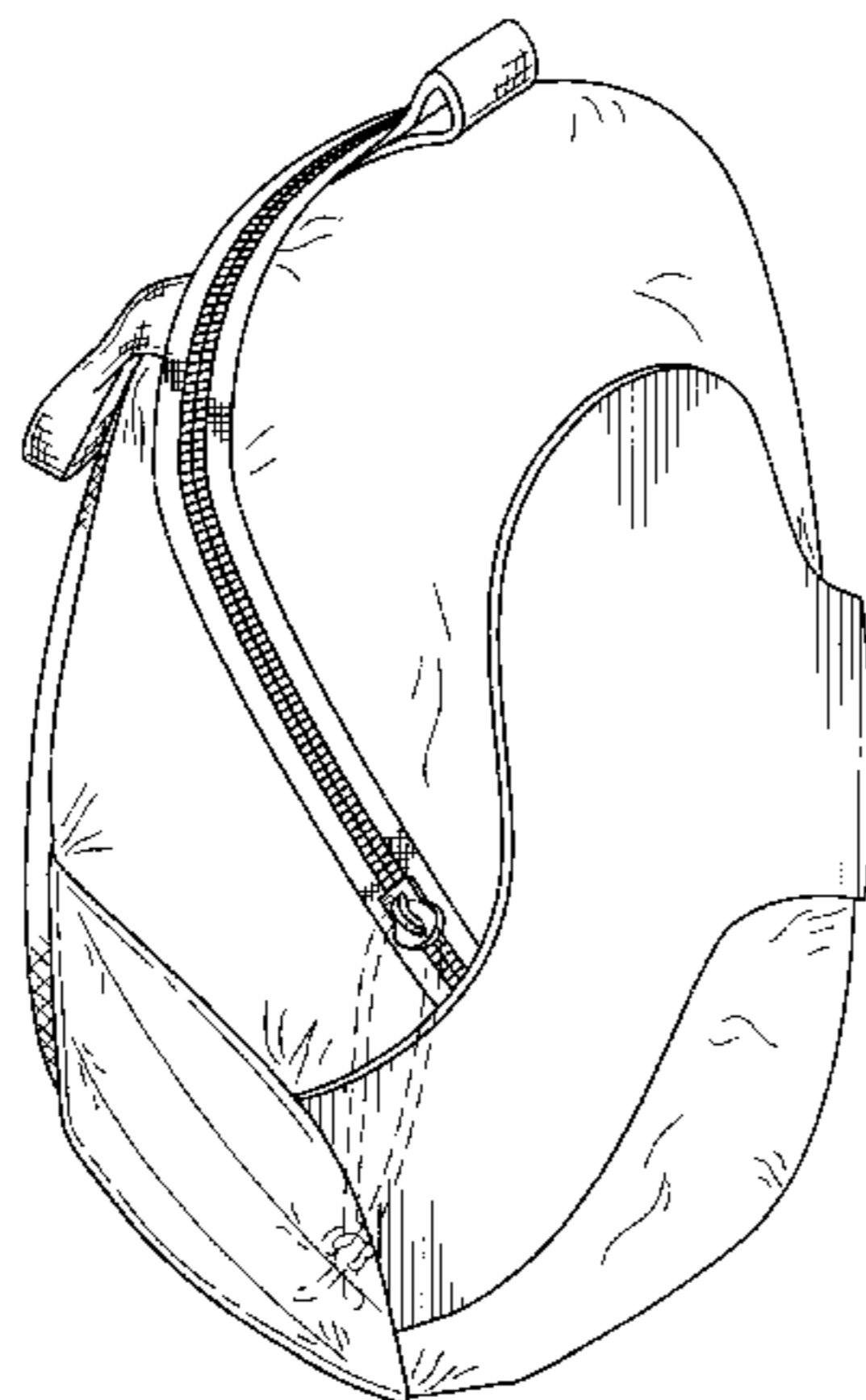

OTHER PUBLICATIONS

HFD "Buyers' Guide to Entertainment Storage Accessories", back cover.

Case Connect Product Brochure, pp. 2, 3, 8, 9, 12 and 13.

2001 Case It Catalog, front cover, pp. 3, 4, 10 and 12.

Fellowes Home & Office Solutions, pp. 113 and 114-116.

CdProjects Millenimum<sup>2</sup> Catalog, pp. 4, 8, 10, 18, 20, 26.

\* cited by examiner

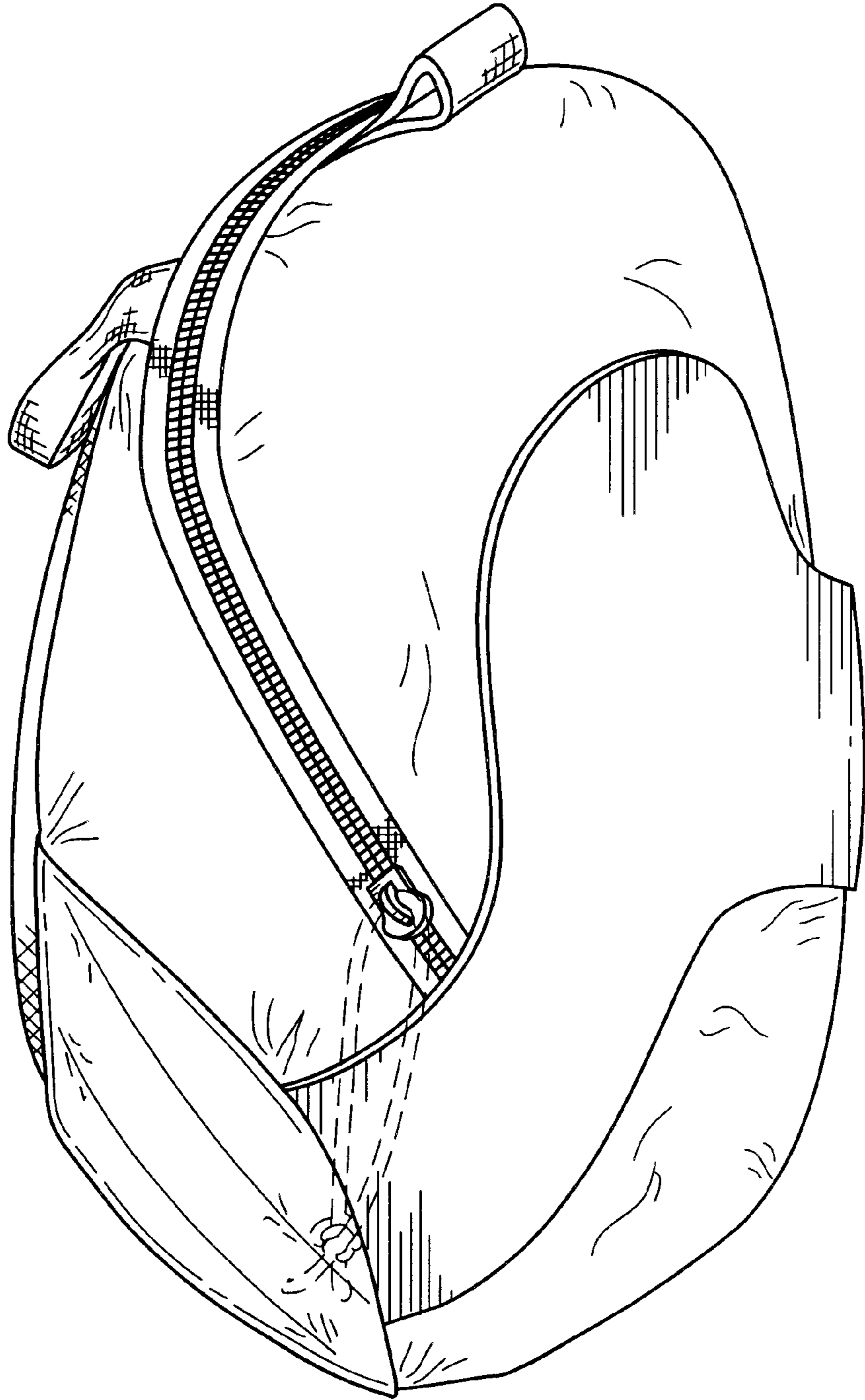

FIG. 1

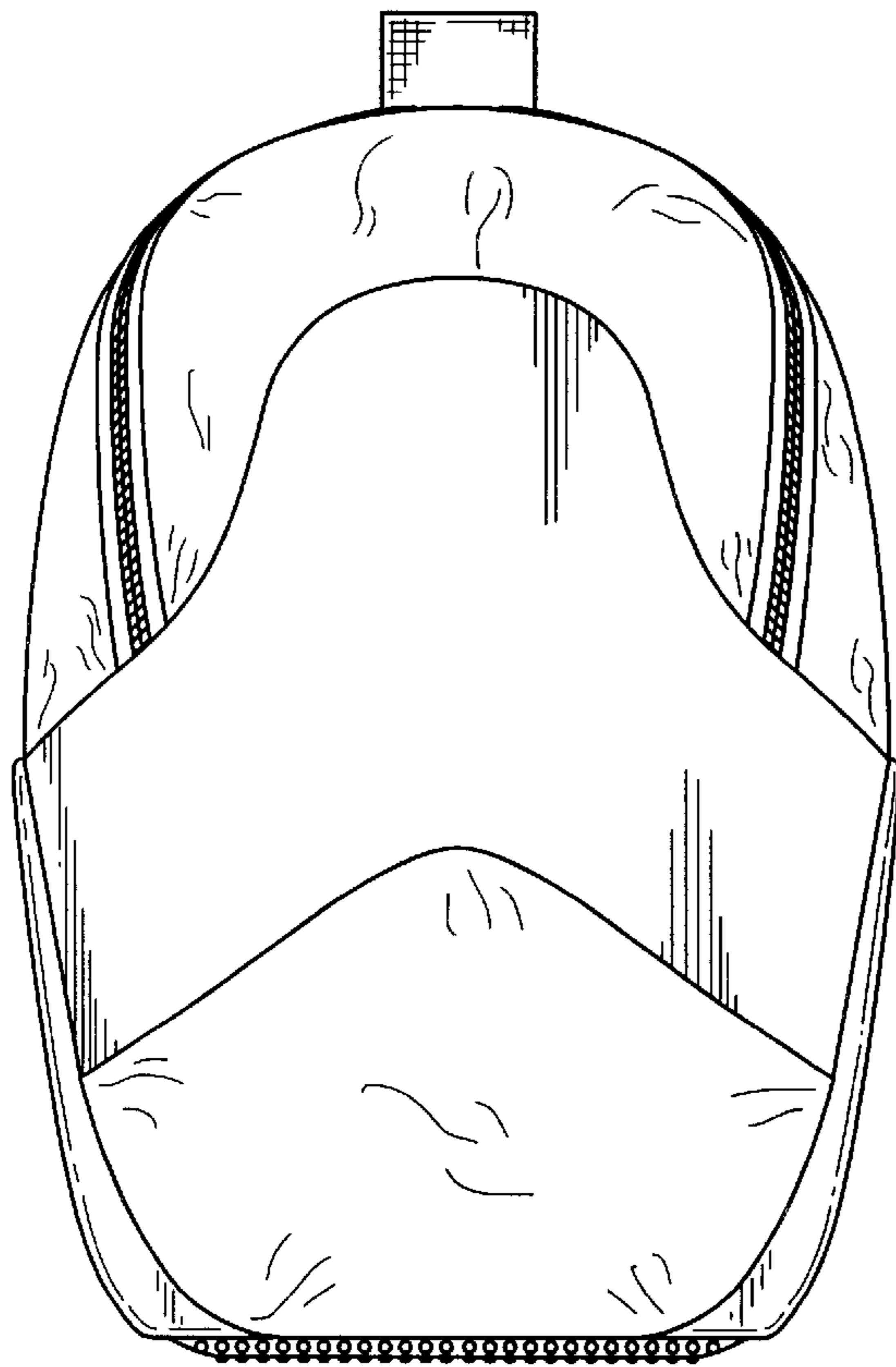

FIG. 2

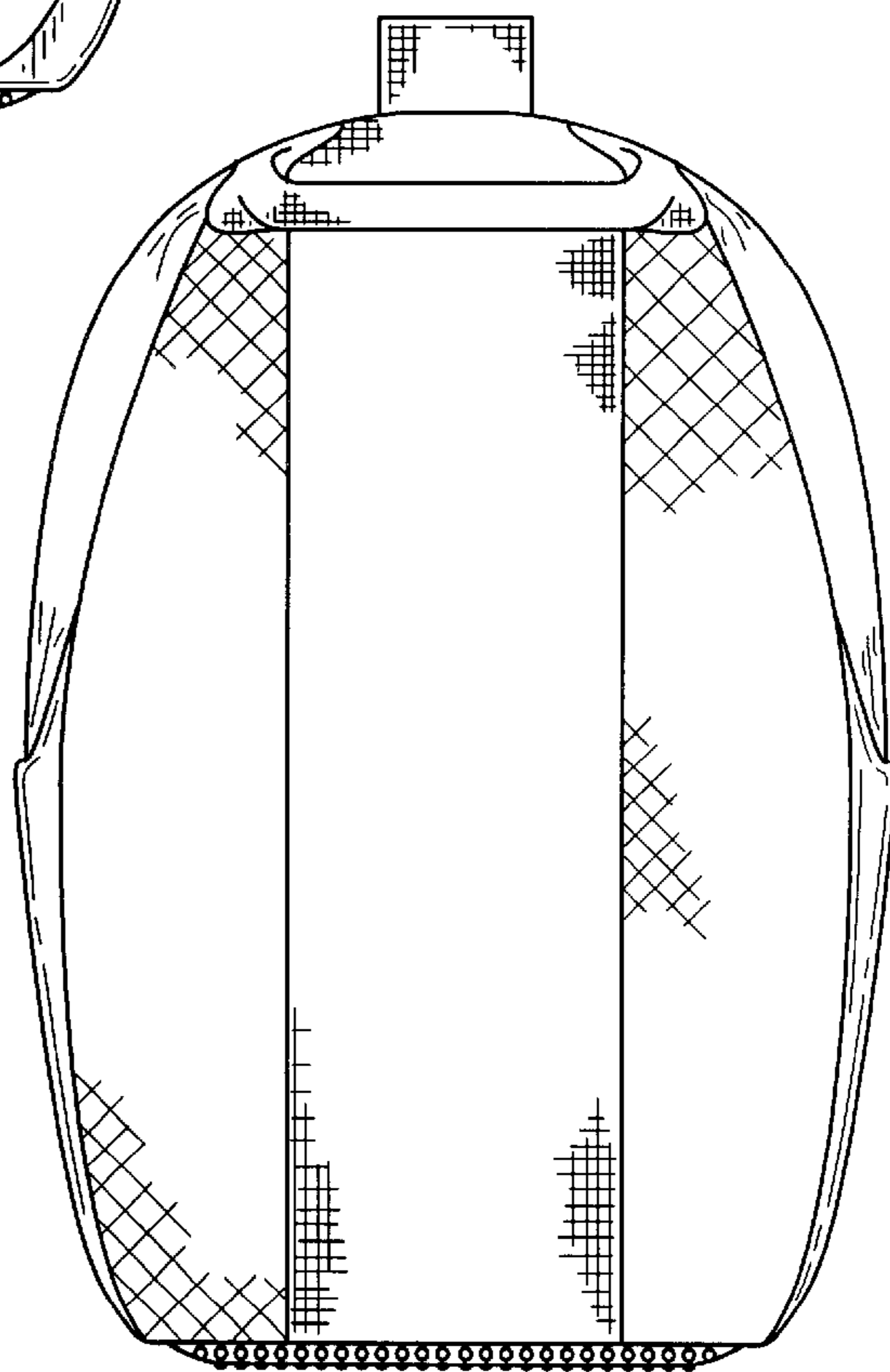

FIG. 3

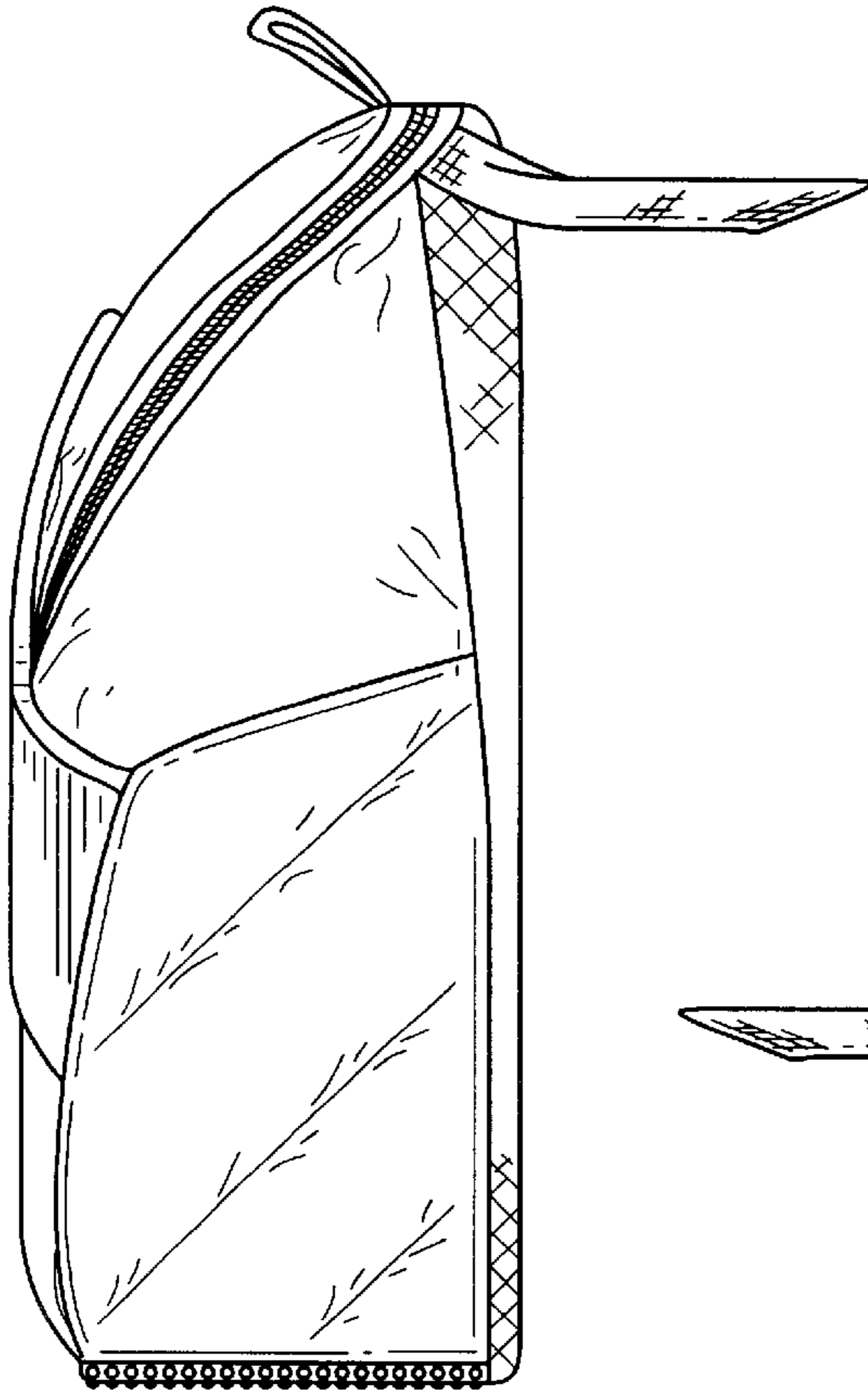

FIG. 4

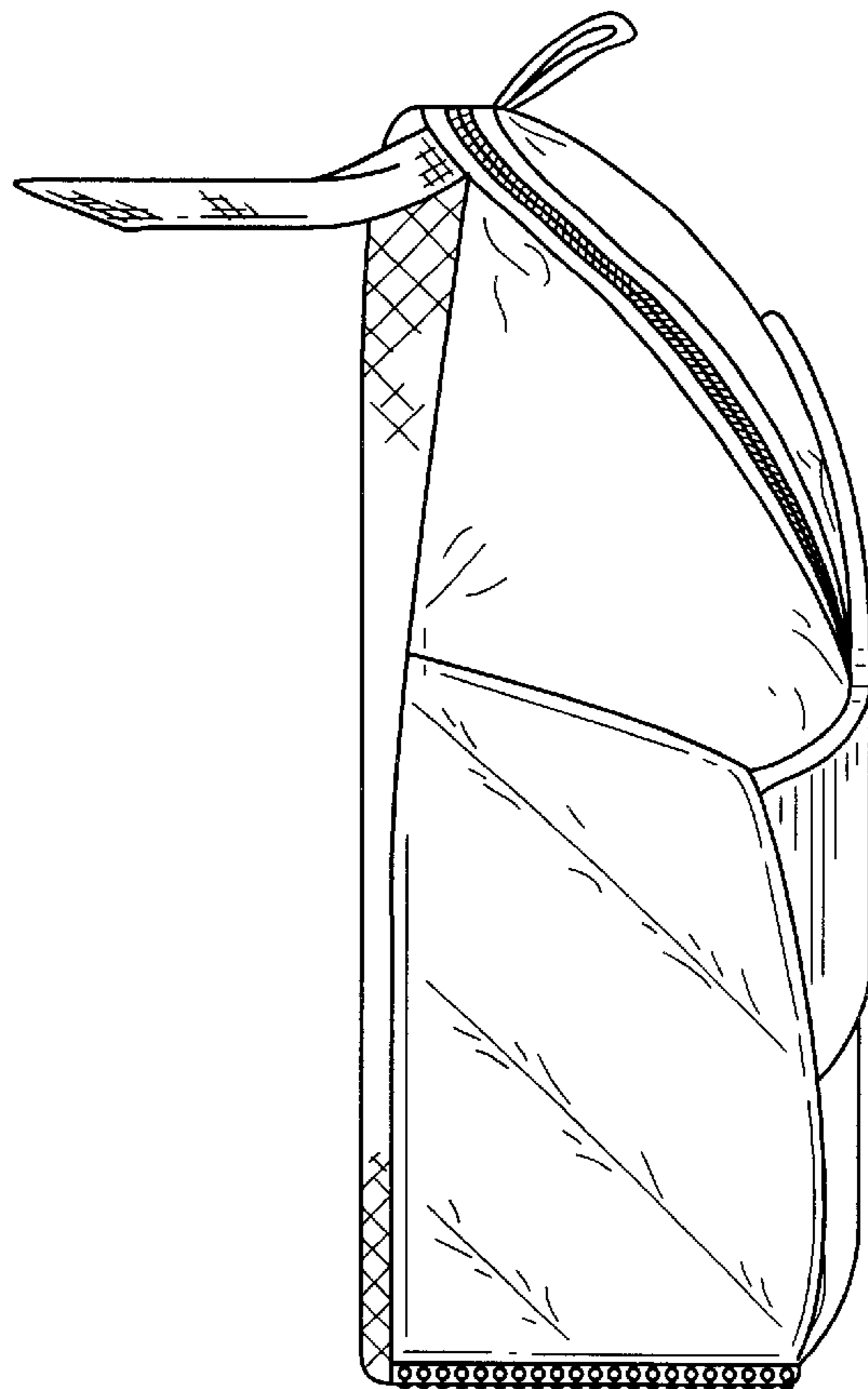

FIG. 5

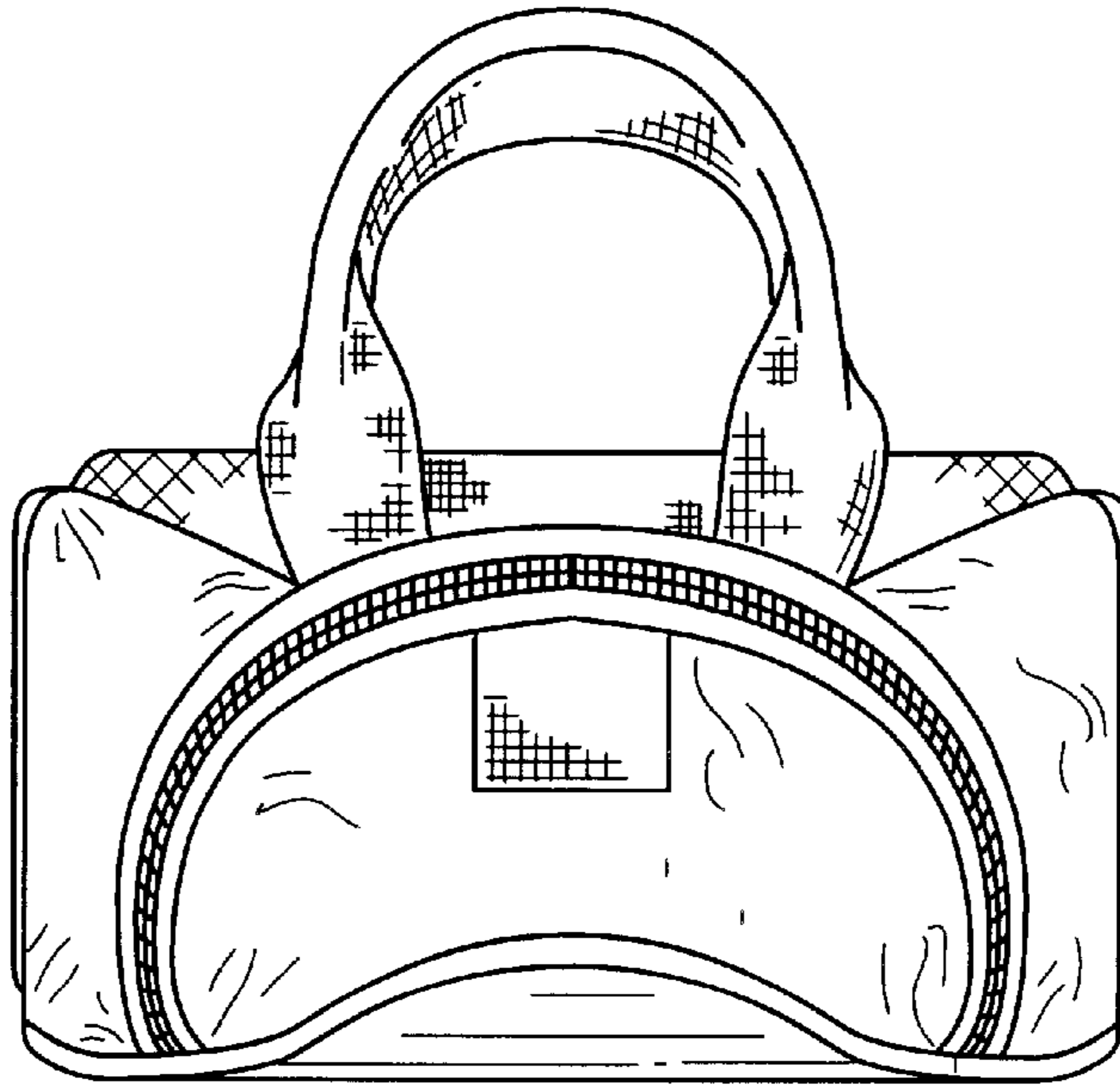

FIG. 6

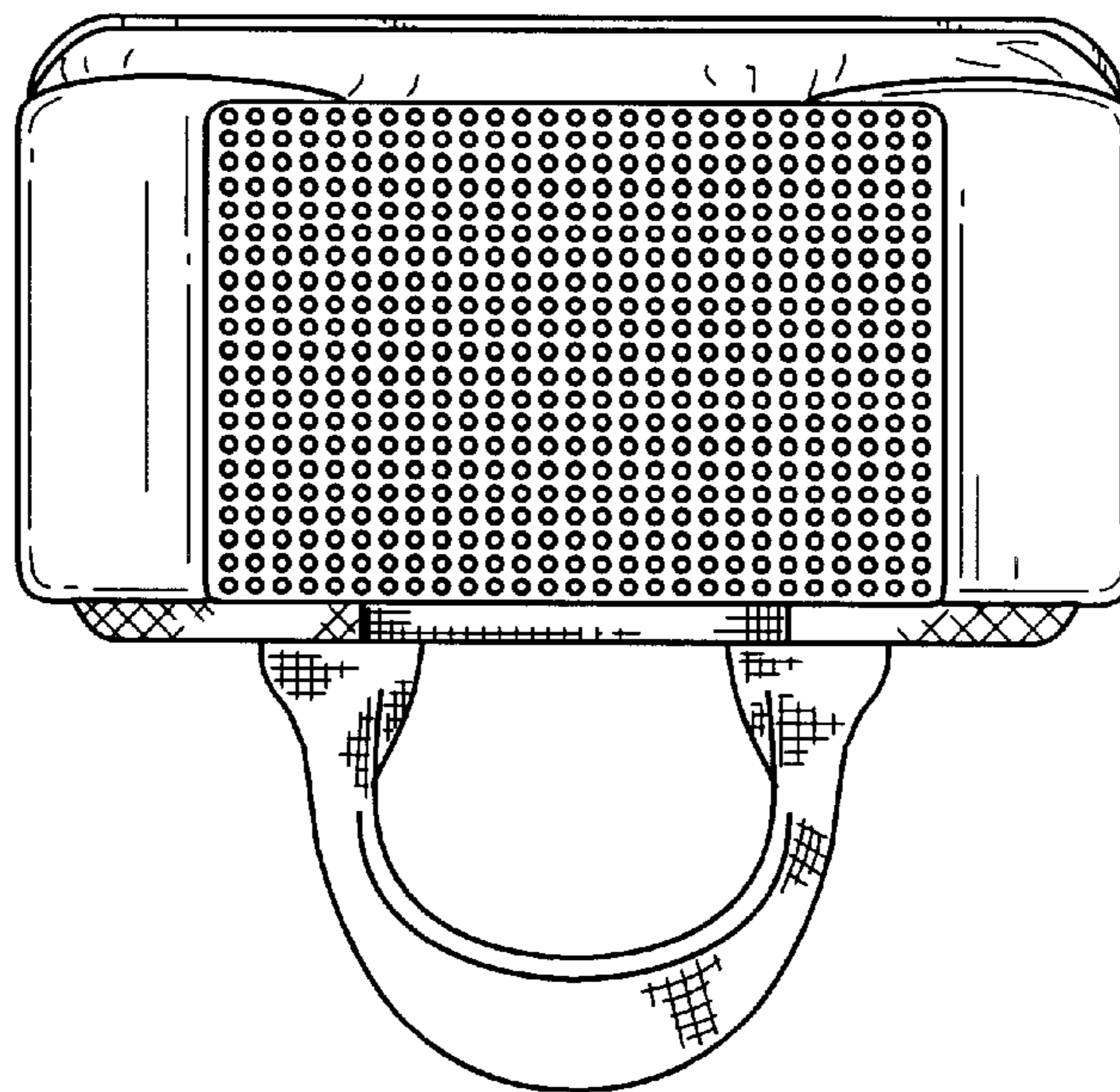

FIG. 7

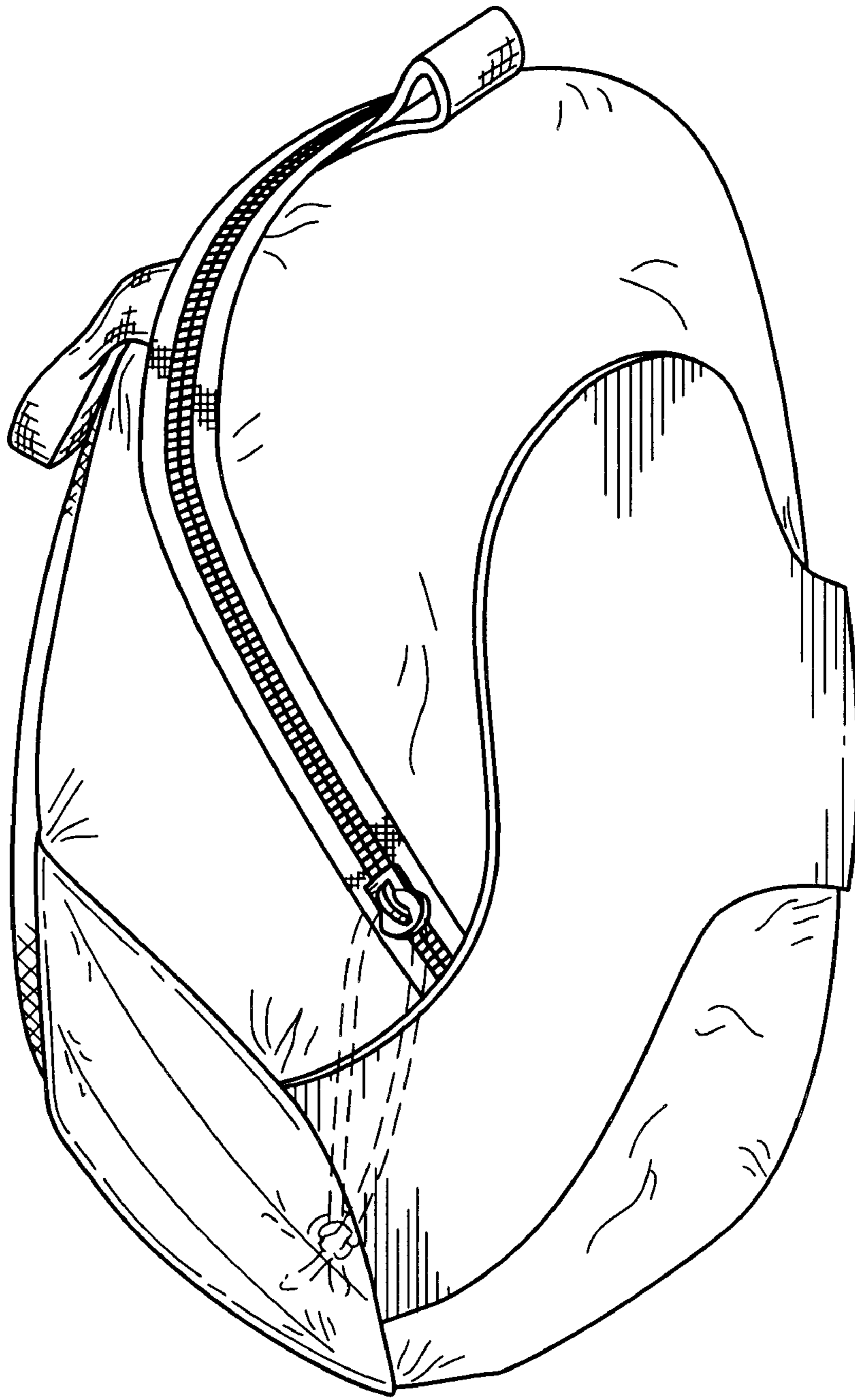

FIG.8