



US00D482821S

(12) **United States Design Patent**
Seifert

(10) **Patent No.:** **US D482,821 S**

(45) **Date of Patent:** **** Nov. 25, 2003**

(54) **DEPILATOR**

(75) Inventor: **Cornelia Seifert**, Bad Soden (DE)

(73) Assignee: **Braun GmbH** (DE)

(**) Term: **14 Years**

(21) Appl. No.: **29/168,380**

(22) Filed: **Oct. 1, 2002**

(30) **Foreign Application Priority Data**

Apr. 3, 2002 (DE) 4 02 02 935

(51) **LOC (7) Cl.** **28-03**

(52) **U.S. Cl.** **D28/44.1**

(58) **Field of Search** D28/44, 44.1,
D28/45-54; 30/526, 34.05, 34.1, 34.2, 41.9,
43, 43.1, 43.2, 43.3, 43.91, 43.92, 48-50,
85

(56) **References Cited**

U.S. PATENT DOCUMENTS

D217,529 S * 5/1970 Haynes D28/49
D363,119 S 10/1995 Schneider
D402,402 S 12/1998 Schneider et al.
D438,341 S 2/2001 Schneider et al.

D447,601 S * 9/2001 Andrew et al. D28/49
D450,157 S * 11/2001 Yiu D28/44.1
D456,945 S * 5/2002 Ullmann D28/49

FOREIGN PATENT DOCUMENTS

DE 401 05 885.9 6/2001
WO DM/057 430 10/2001

* cited by examiner

Primary Examiner—Jennifer Rivard

(74) *Attorney, Agent, or Firm*—Fish & Richardson PC

(57) **CLAIM**

The ornamental design for a depilator, as shown and described.

DESCRIPTION

FIG. 1 is a perspective view of a depilator showing my design;
FIG. 2 is a front view of the appliance thereof;
FIG. 3 is a right side view of the appliance thereof
FIG. 4 is a left side view of the appliance thereof;
FIG. 5 is a rear view of the appliance thereof;
FIG. 6 is a top plan view of the appliance thereof; and,
FIG. 7 is bottom plan view of the appliance thereof.

1 Claim, 4 Drawing Sheets

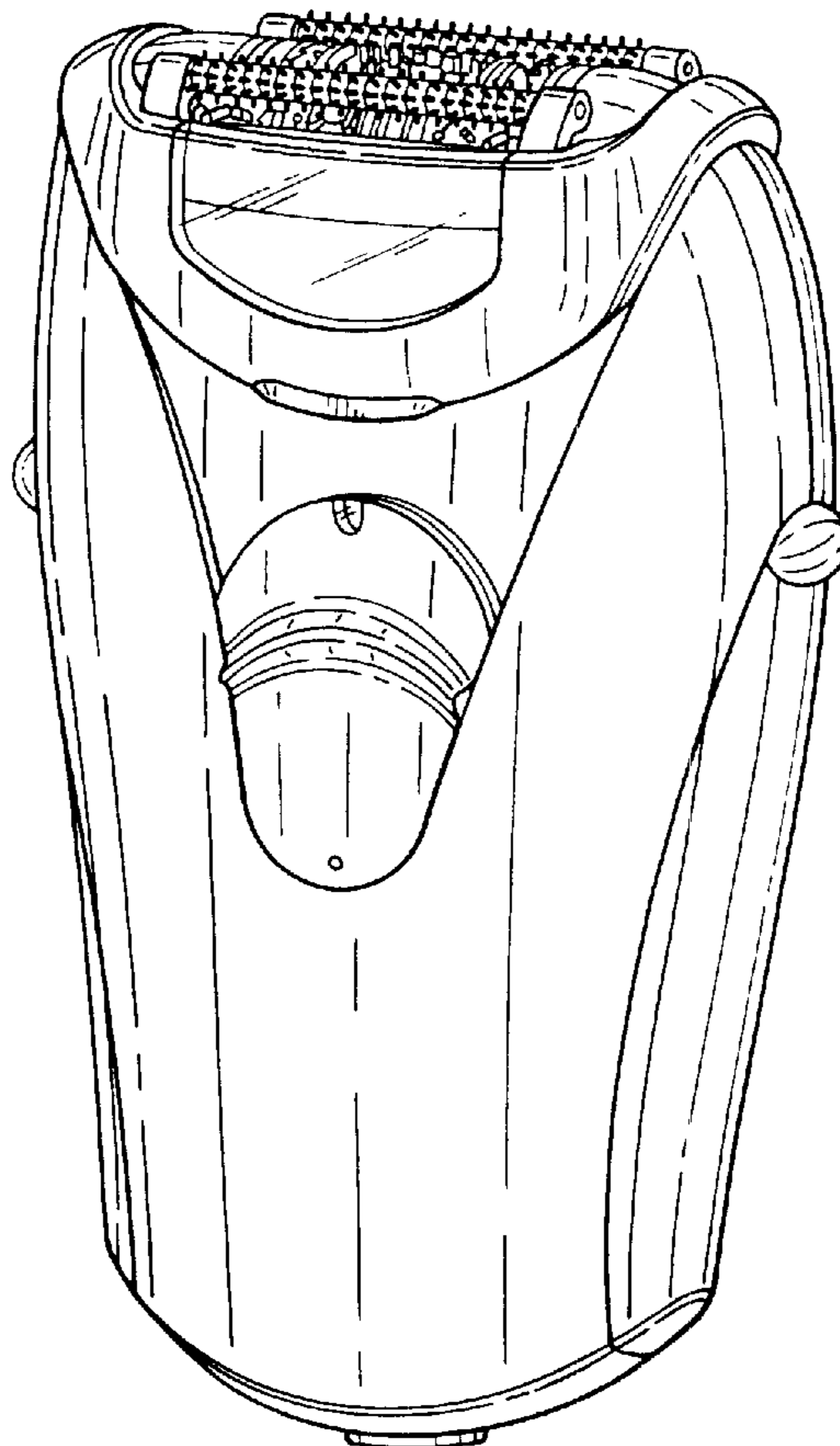

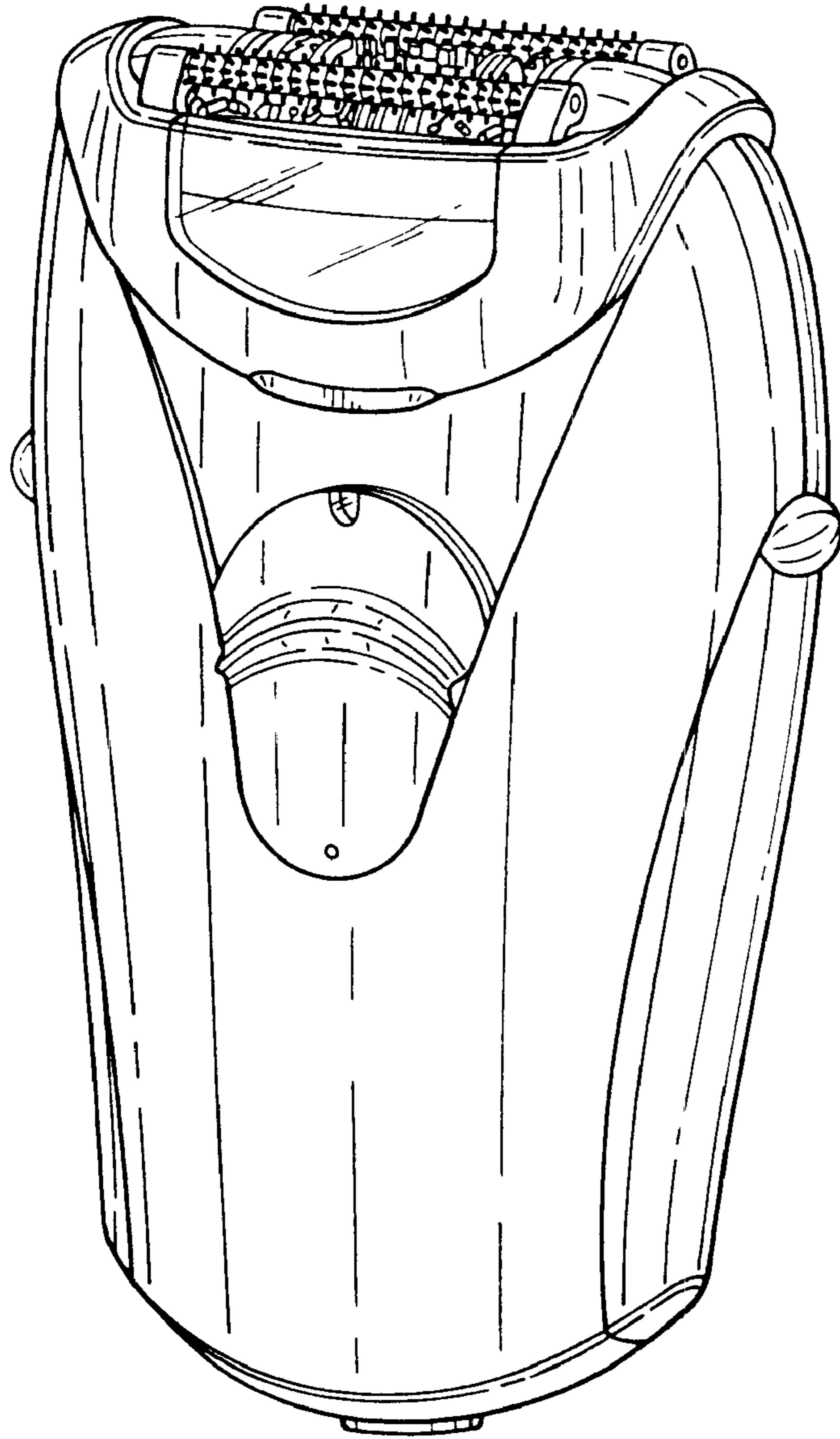

Fig. 1

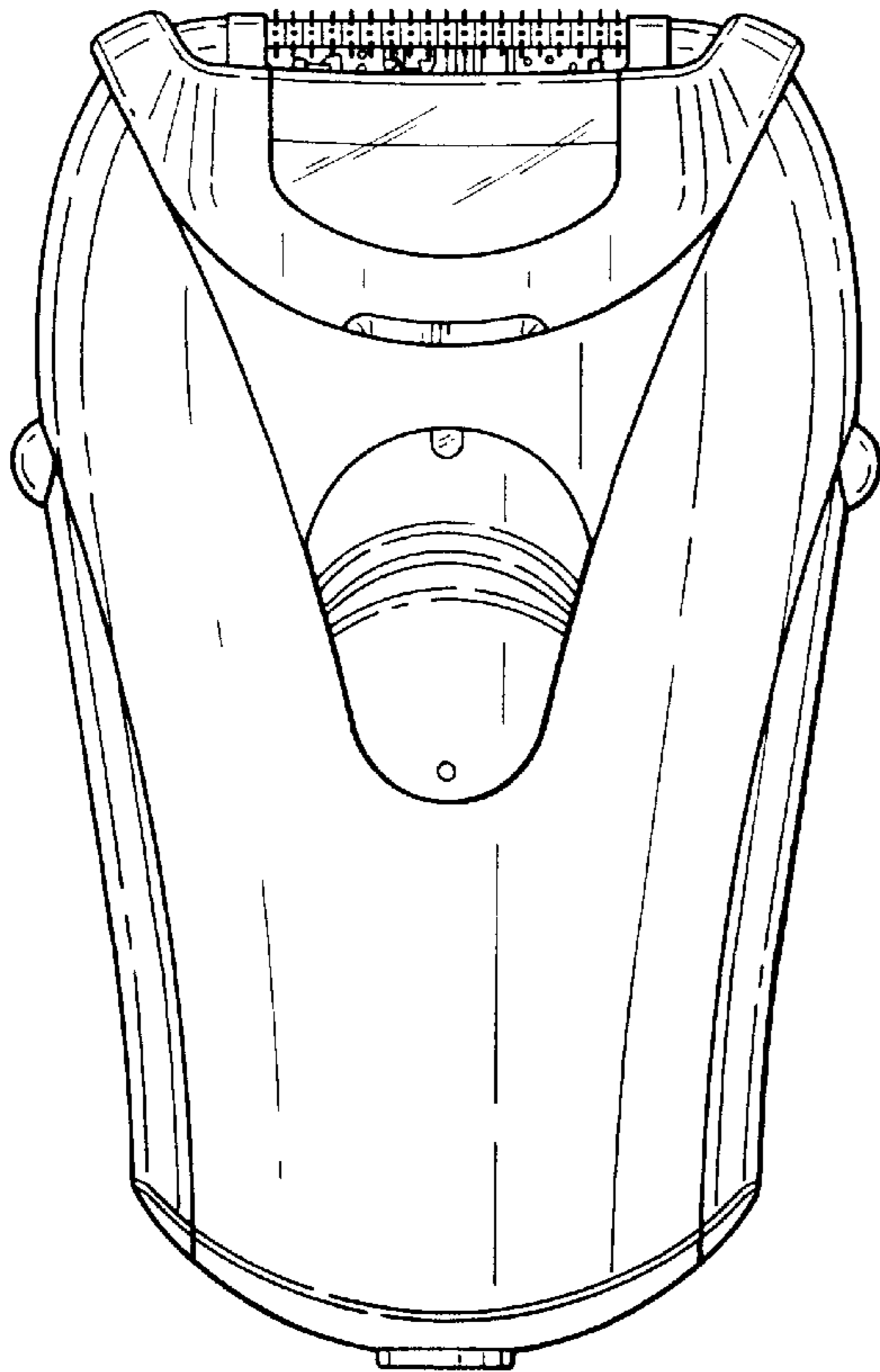

Fig. 2

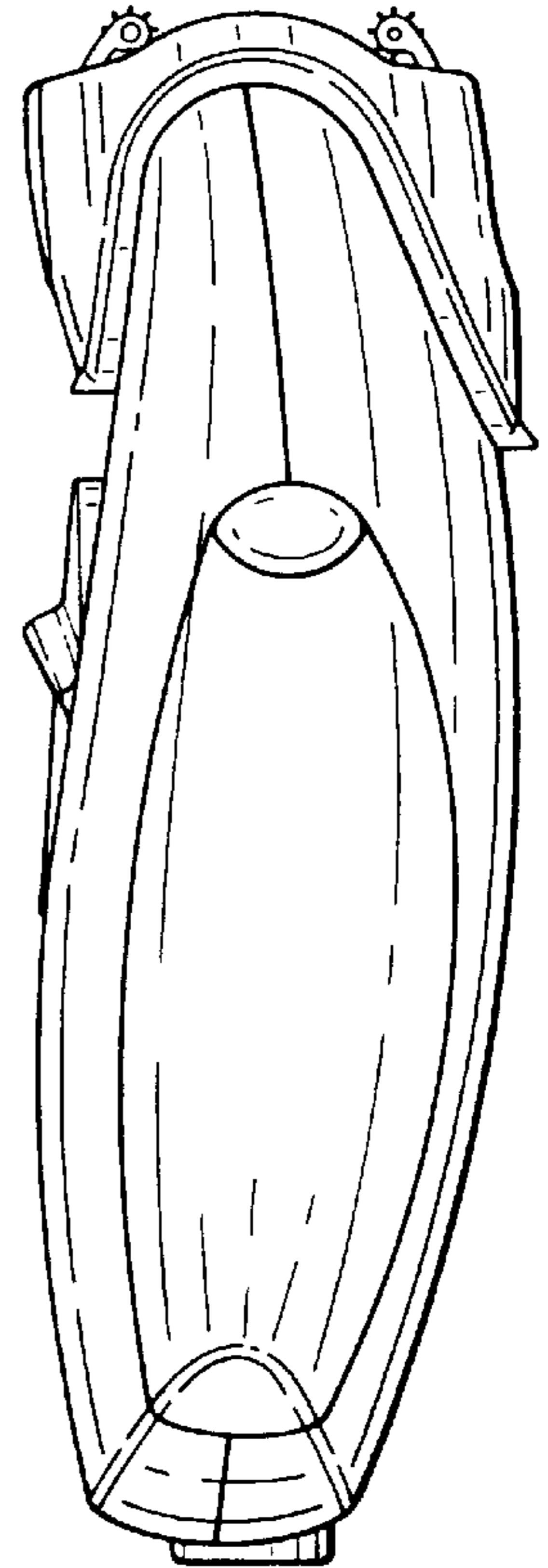

Fig. 3

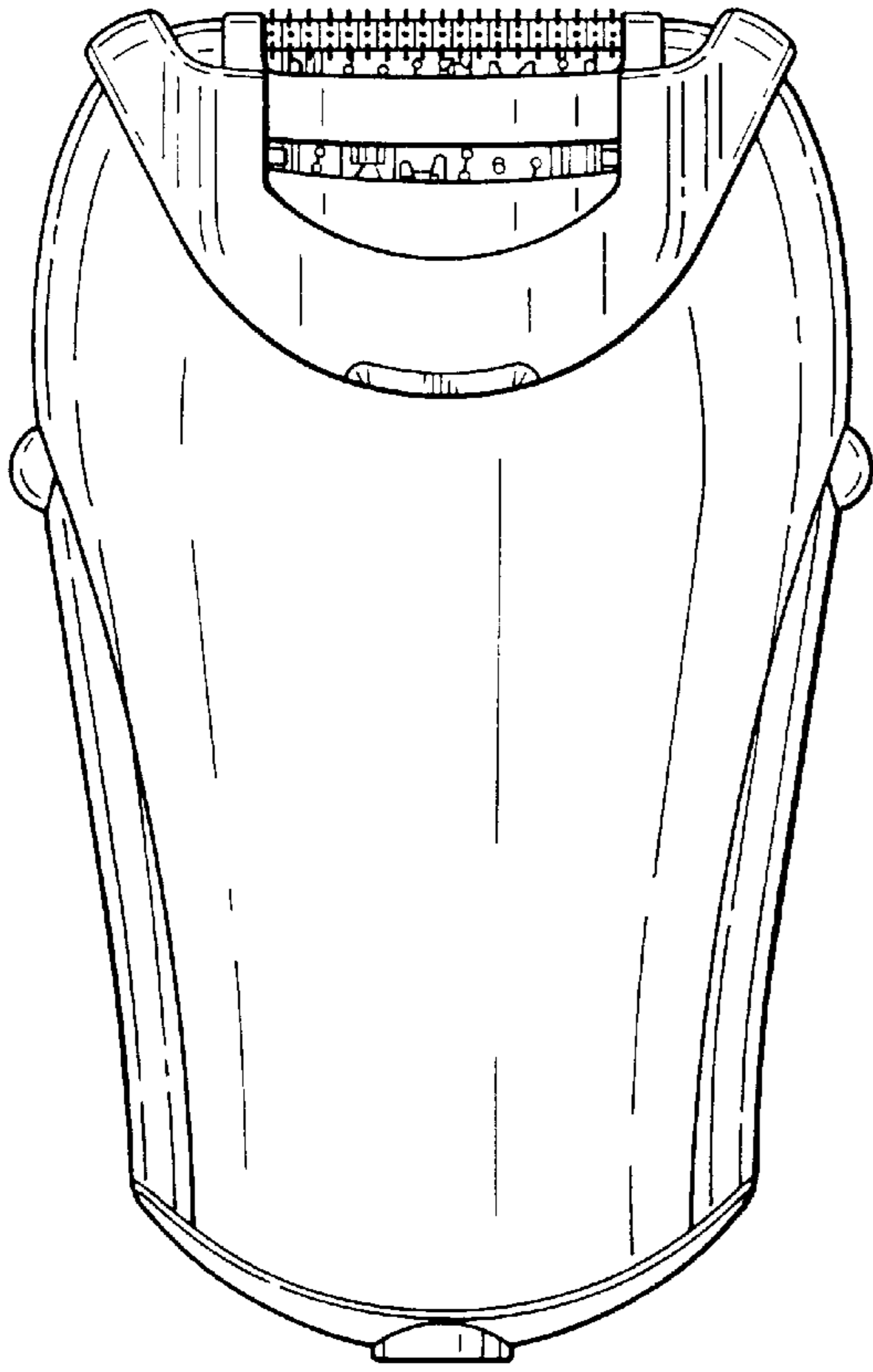

Fig. 5

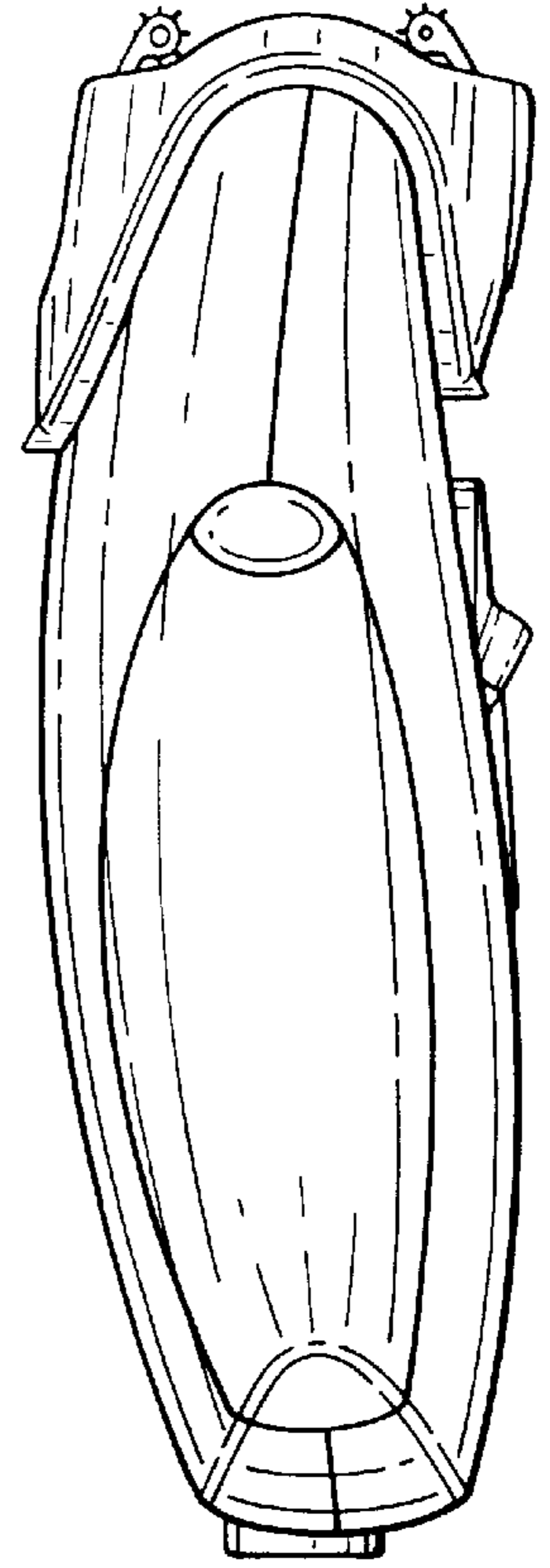

Fig. 4

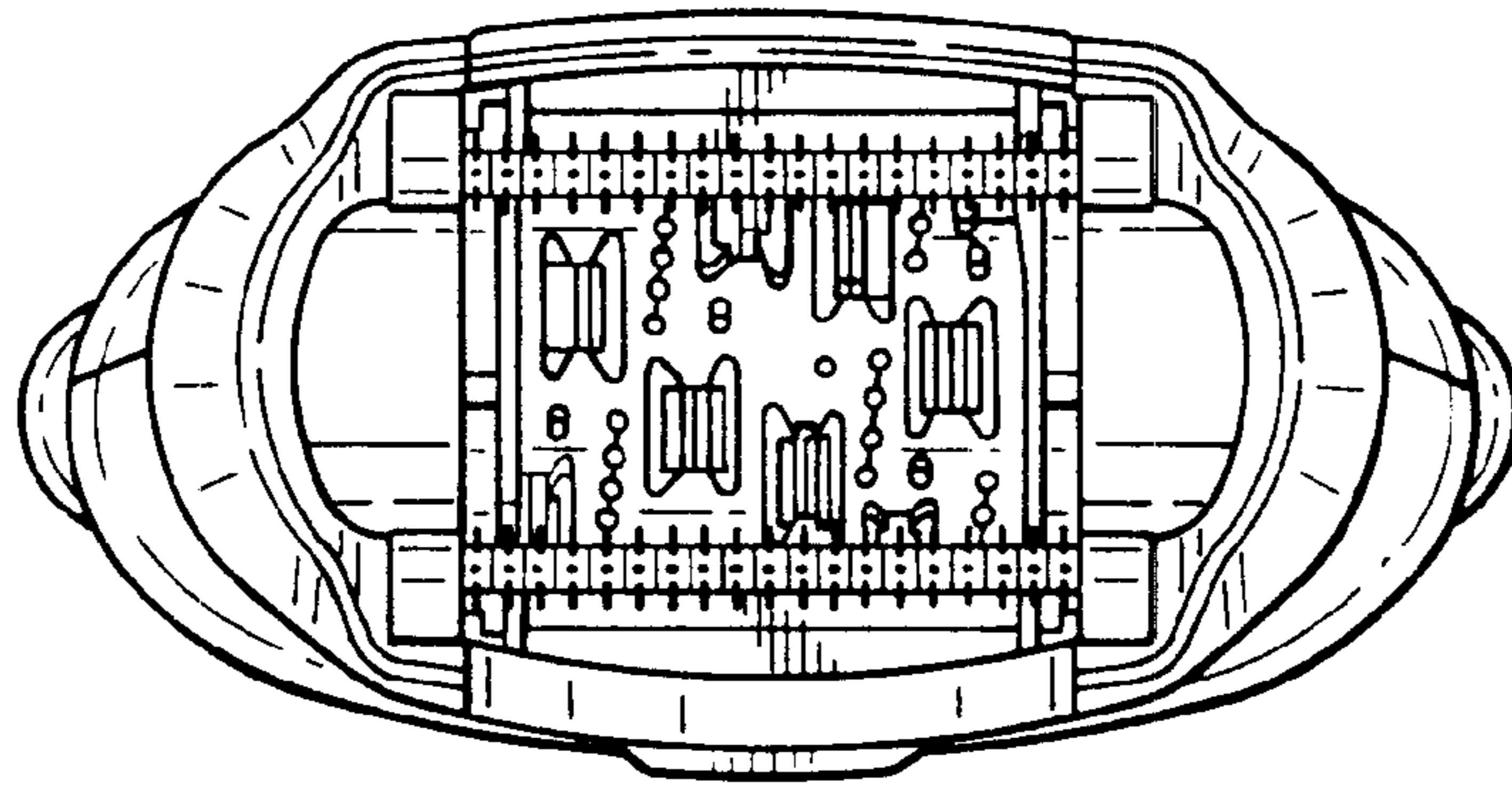

Fig. 6

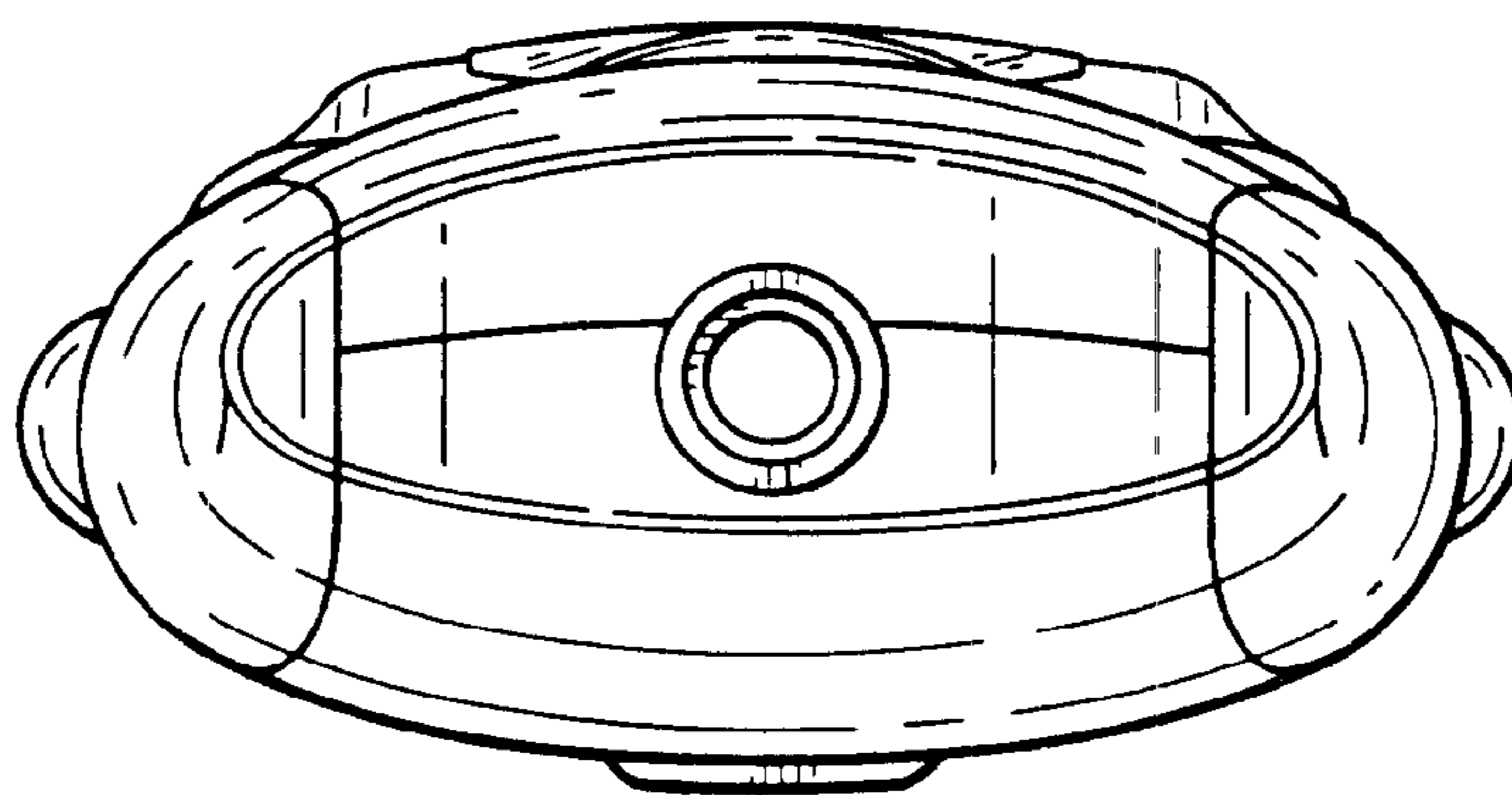

Fig. 7